

INTRODUCTION TO RADIOACTIVITY AND RADIATION

BASIC CONCEPTS

The Atom

- It is the basic building block of matter
- It consists of two components:

Electron(s)

Nucleus

Electron

- Point particle (lepton), it is not made up of smaller particles
- Has mass
- Has an electrical charge -1 (1.6×10^{-19} coulombs)

Electron

- The energy levels of electrons in an atom are referred to as shells.

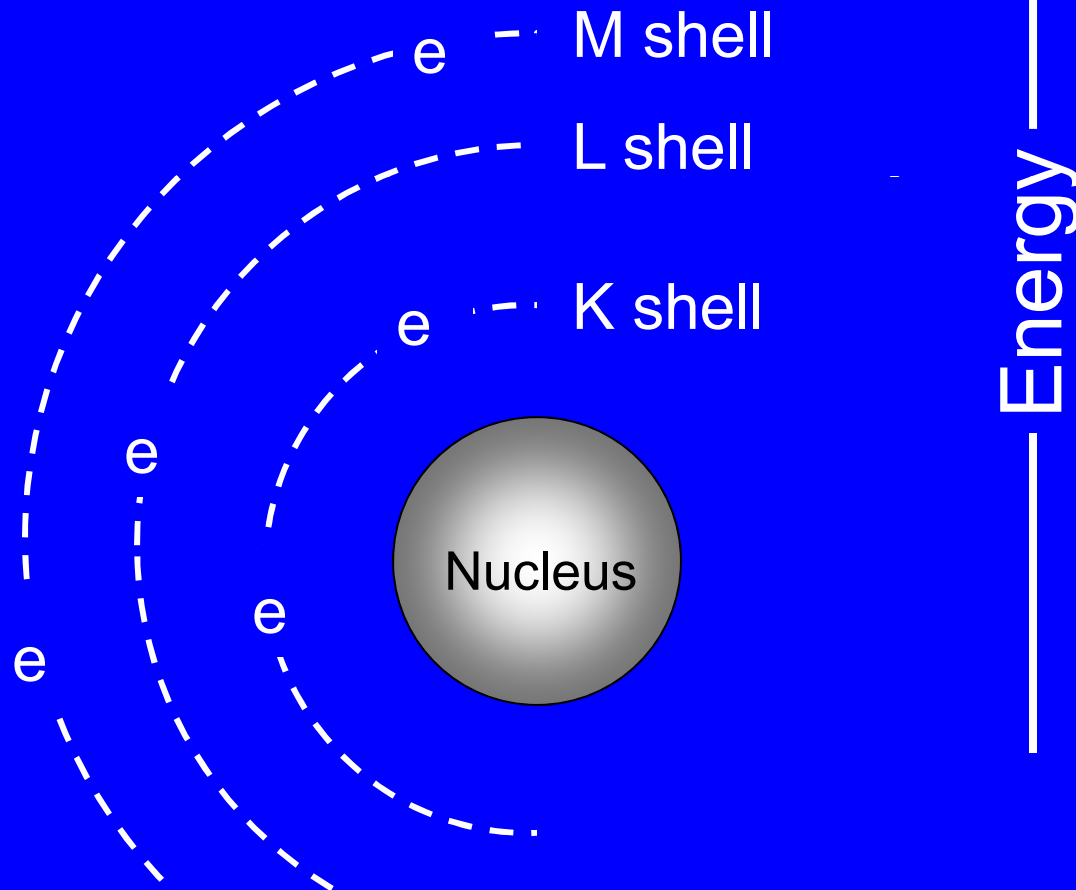

Electron

- Only a specific number of electrons is allowed in each shell (energy level).
- Electrons (like all particles) “want” to occupy the lowest possible energy level.
- The number of electrons in the valence shell (highest occupied shell) determines the chemical properties of the atom.
- When an electron moves (undergoes a transition) to a lower energy level, it must release energy.

Electron

- When an electron fills a vacancy in an inner shell (moves to a lower energy level), the released energy might take the form of a characteristic x-ray.

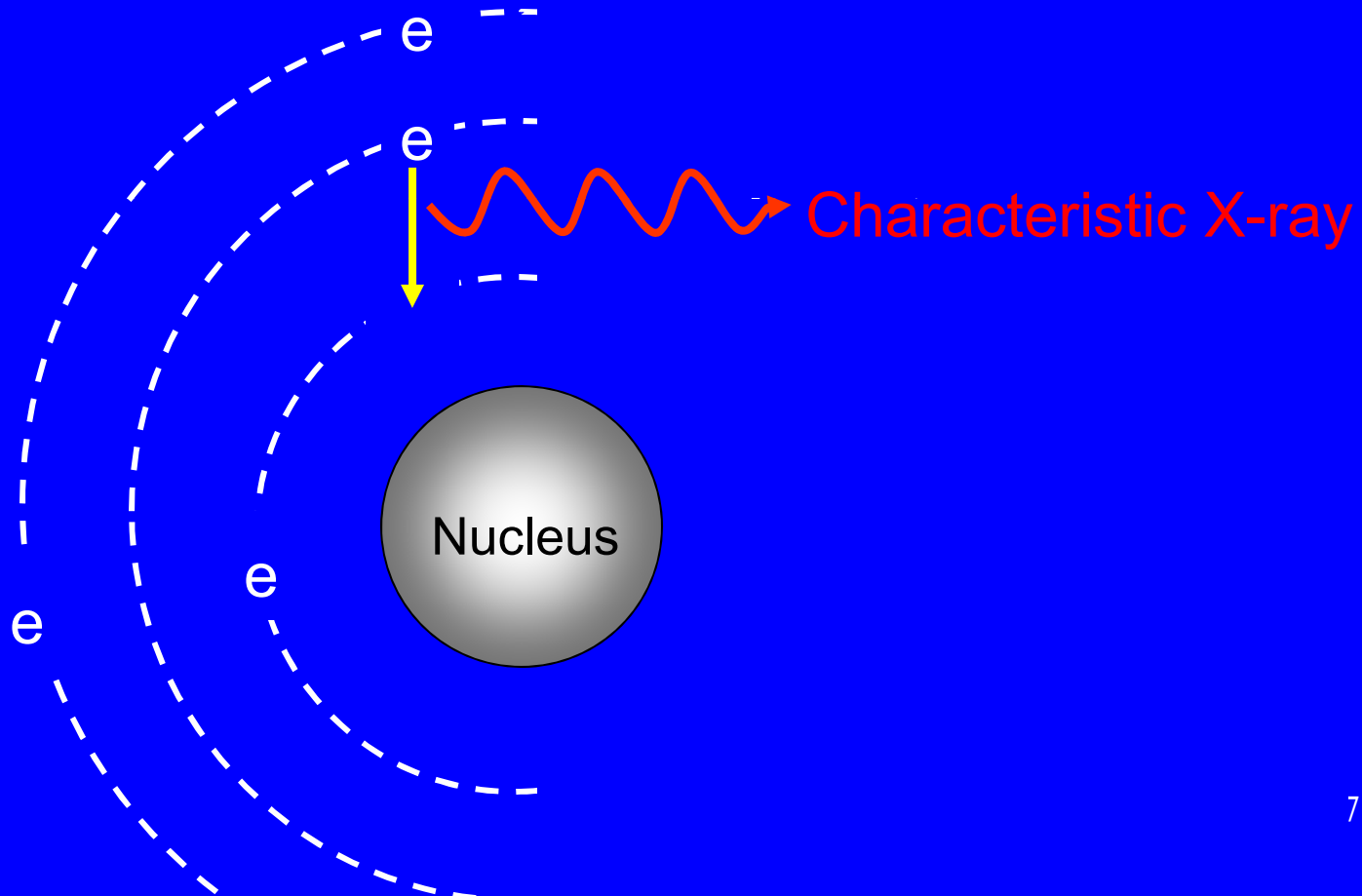

X-ray

- An x-ray is electromagnetic radiation (emr) that is emitted when an electron loses energy.
- X-rays are part of the electromagnetic spectrum which includes radio waves, infra-red radiation, visible light, ultra-violet radiation and gamma rays.
- X-rays (and gamma rays) have a high enough energy to ionize atoms (remove electrons from atoms) and are therefore considered a type of ionizing radiation.

X-ray

- X-rays can be treated as if they are particles (called photons) or they can be treated as waves.
- Most of the time it is best to think of x-rays as photons rather than waves.
- A photon is a packet of electromagnetic energy.
- Photons have no mass or charge.
- Unless they interact, they travel in straight lines at the speed of light.

X-ray

There are two types of x-rays:

1. Characteristic x-rays.

Produced by atomic electrons as they fall from one shell (energy level) to a lower shell, e.g., L shell to K shell.

Monoenergetic. The energy depends on atomic number.

2. Bremsstrahlung.

Produced by “free” electrons as they change direction and slow down, e.g., electrons striking an x-ray tube target.

Have a range of energies. Sometimes called continuous x-rays.

The Nucleus

- The nucleus forms the central dense core of the atom (ca. 10^{-12} cm diameter). It consists of particles referred to as nucleons. There are two types of nucleons: protons and neutrons.
- A nucleus contains at least one proton.
- Most nuclei also contain one or more neutrons.

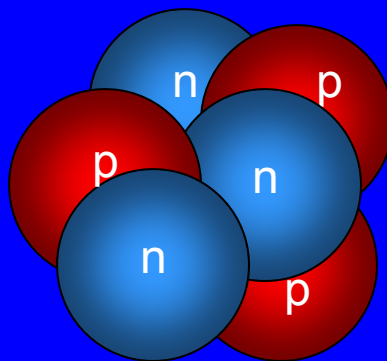

Quarks

- Protons and neutrons are composed of quarks.
- There are six different types of quarks.

u	up
d	down
t	top (truth)
b	bottom (beauty)
c	charm
s	strange

- Quarks have an electrical charge, e.g., up quarks have a charge of $+2/3$ while down quarks have a charge of $-1/3$

The Nucleus

Proton

- Positive charge (+1)
- Three quarks:
 - u (+2/3)
 - u (+2/3)
 - d (-1/3)

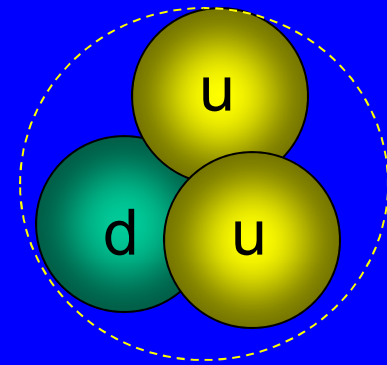

Neutron

- No charge (neutral)
- Three quarks:
 - u (+2/3)
 - d (-1/3)
 - d (-1/3)

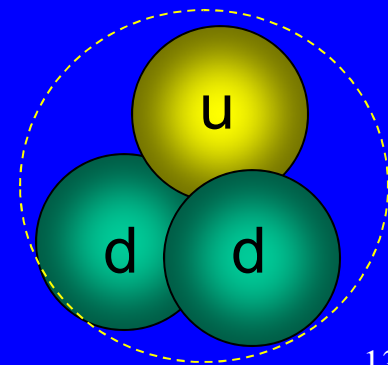

Nuclide

- A nuclide is an atom or a group of atoms that have a specific combination of neutrons and protons (e.g., six protons and six neutrons).

Describing a Nuclide

A nuclide can be described by specifying:

1. The number of protons. The number of protons is referred to as the **atomic number** and is given the symbol Z .

The number of protons is the same as the number of electrons.

The atomic number specifies the element, e.g., $Z = 1$ (hydrogen), $Z = 2$ (helium), $Z = 3$ (lithium), etc.

Describing a Nuclide

A nuclide can be described by specifying:

1. The number of protons (the atomic number, Z).
2. The number of neutrons. The number of neutrons is referred to as the **neutron number** and is given the symbol N .

The neutron number has nothing to do with the element. If an atom has two protons, it is helium. It might have 0, 1, 2, 3 or more neutrons.

Describing a Nuclide

A nuclide can be described by specifying:

1. The number of protons (the atomic number, Z).
2. The number of neutrons (the neutron number, N).
3. The total number of protons and neutrons. The total number of nucleons is referred to as the **atomic mass number** and is given the symbol A .

$$A = Z + N$$

Symbolizing a Nuclide

A nuclide can be symbolized as follows:

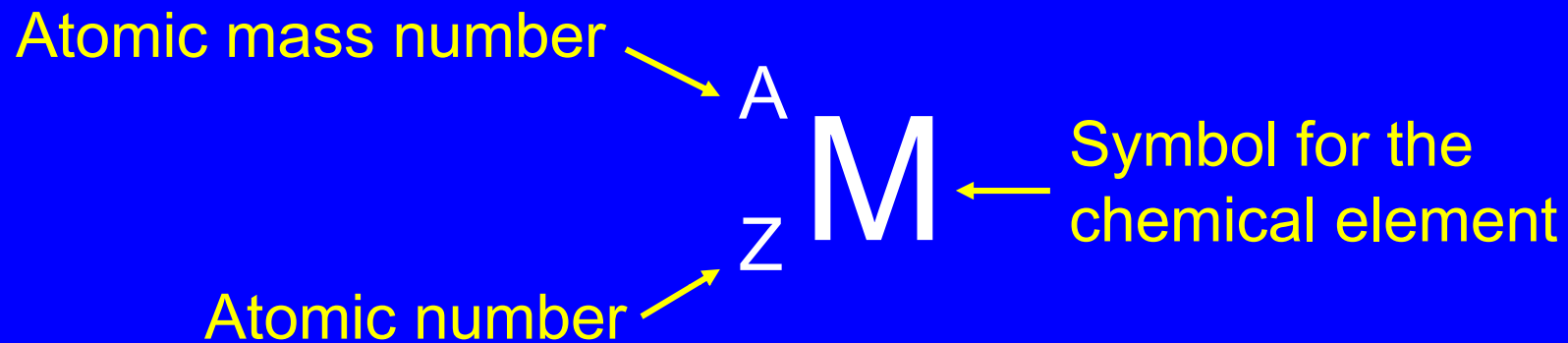

For simplicity, it is more common to ignore the atomic number and follow the symbol for the element with the atomic mass number:

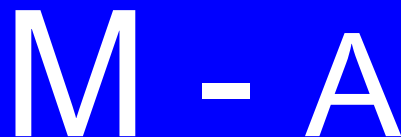

Symbolizing a Nuclide

Examples:

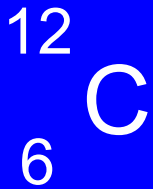

6 protons and 6 neutrons, referred to as carbon twelve, also symbolized C-12

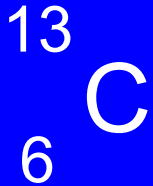

6 protons and 7 neutrons, referred to as carbon thirteen, also symbolized C-13

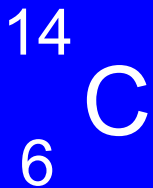

6 protons and 8 neutrons, referred to as carbon fourteen, also symbolized C-14

Two Types of Nuclides

1. Stable nuclides.
2. Radionuclides.

C-12 ?

C-13

C-14

Two Types of Nuclides

1. Stable nuclides.
2. Radionuclides.

C-12 stable nuclide

C-13

C-14 ?

Two Types of Nuclides

1. Stable nuclides.
2. Radionuclides.

C-12 stable nuclide

C-13 ?

C-14 radionuclide

Two Types of Nuclides

1. Stable nuclides.
2. Radionuclides.

C-12 stable nuclide

C-13 stable nuclide

C-14 radionuclide

Three Types of Nuclides

1. **Isotopes.** Different nuclides with the same number of protons, i.e., different nuclides of the same element. U-235, U-238
2. **Isotones.** Different nuclides with the same number of neutrons. C-14, N-15
3. **Isobars.** Different nuclides with the same atomic mass number. Sr-90, Y-90

Mass

- Basic unit: kilogram
- Special unit: atomic mass unit (u or amu)

1 amu $\frac{1}{12}$ mass of C-12

- Mass of a proton. 1.0073 amu
- Mass of a neutron. 1.0087 amu
- Mass of an electron. 0.000549 amu
- Mass of H-1 (proton + electron). 1.0078 amu

Mass

- Mass of C-12 is 12.000 amu even though the sum of the masses of its individual components (6 protons and 6 neutrons) is greater than 12.000 amu.
- The explanation is that mass is lost when these components are brought together to form C-12.

The mass is lost in the form of released energy.

Relationship Between Mass and Energy

- Mass can be converted into energy and energy can be converted into mass.

$$E = m c^2$$

E is energy in joules

m is mass in kilograms

c is the speed of light (meters per second)

- $$E = 931.5 m$$

E is the energy in MeV

m is the mass in amu

Relationship Between Mass and Energy

- The mass of atomic constituents can be expressed as energy.
- Mass of proton . 931.5 MeV
- Mass of neutron . 931.5 MeV
- Mass of electron = 931.5 MeV/amu x 0.000549 amu
= 0.511 MeV
= 511 keV

Binding Energy

- The binding energy of a nuclide is the energy released when the nuclide is formed from its constituent parts, i.e., protons, neutrons and electrons.
- It is the energy equivalent of the mass defect.
- The mass defect is the difference between the mass of the nuclide and the mass of the constituent parts.

Binding Energy

- For example, the mass defect of C-12 is the mass of 6 protons, 6 electrons and 6 neutrons minus the mass of C-12:

$$= 6(1.0078 \text{ amu}) + 6(1.0087 \text{ amu}) - 12 \text{ amu}$$

$$= 0.099 \text{ amu}$$

- As such, the total binding energy is:

$$= 0.099 \text{ amu} \times 931.5 \text{ MeV/amu}$$

$$= 92.2 \text{ MeV}$$

Binding Energy per Nucleon

- The binding energy per nucleon is the total binding energy of the nuclide divided by the number of nucleons (the atomic mass number).
- As an example, the binding energy per nucleon for C-12 is approximately 7.7 MeV ($92.2 \text{ MeV} \div 12$)
- The production of nuclides whose binding energy per nucleon is greater than that of the reactants results in the release of energy. The following graph indicates that energy is released by the fusion of nuclides of low atomic mass numbers and the fission of nuclides with high atomic mass numbers.

Binding Energy per Nucleon

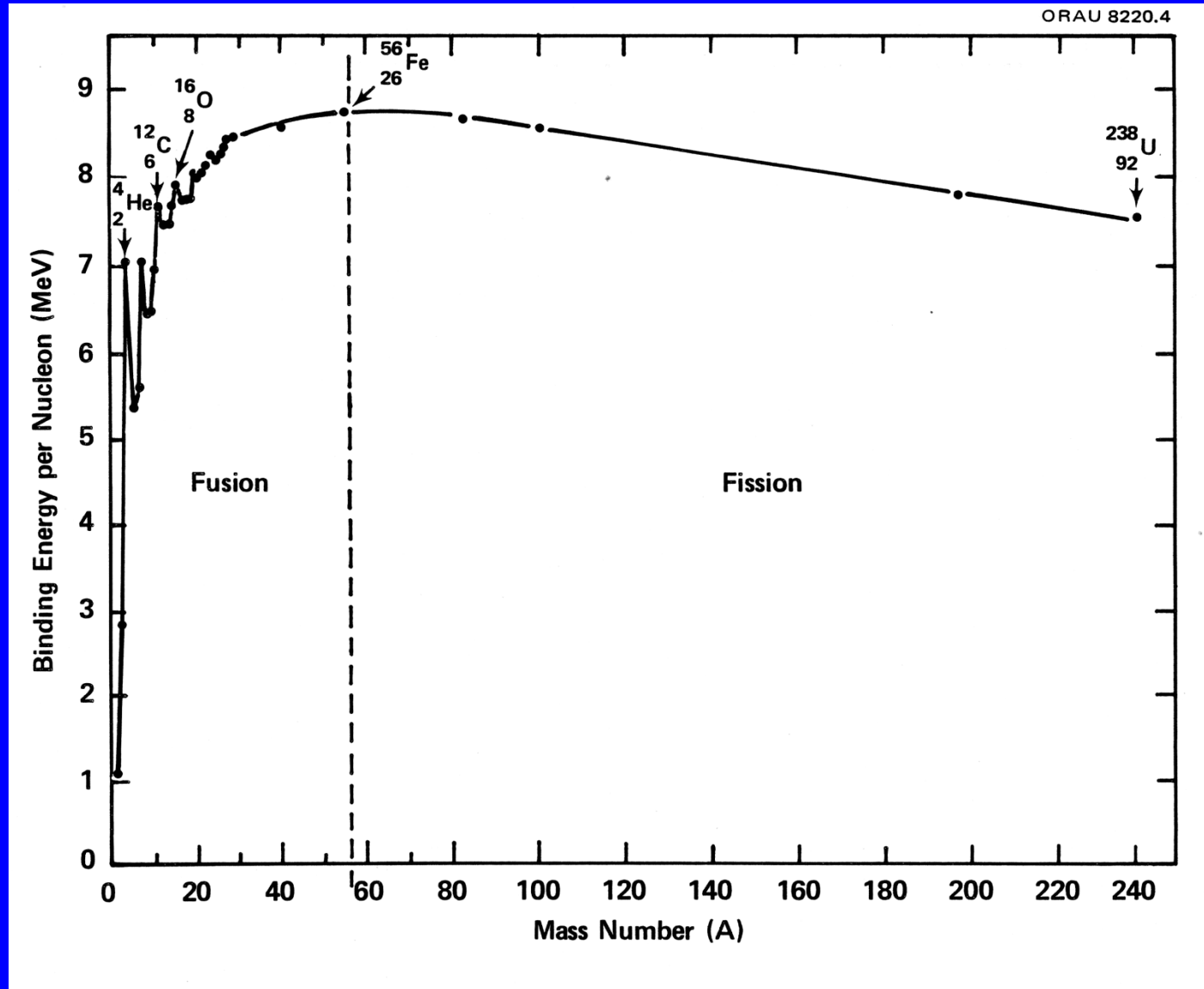

Binding Energy of a Particle

- The binding energy of a particle (e.g., electron, neutron, proton) is the energy that is required to remove the particle from the atom.
- It depends on the type of particle (e.g., electron vs. neutron) and the atom (e.g., H-2 vs. Pb-206).
- It is not energy that is possessed by the particle.
- For example, the neutron binding energy in C-13 is the energy released when a neutron is absorbed by C-12 to form C-13. The same energy is required to remove a neutron from C-13.

THE CHART OF THE NUCLIDES

Chemistry

- Chemists are interested in electrons because the number of electrons and their distribution in the electron shells determines the chemical properties of the atom.
- The **Periodic Table** organizes the various elements according to the number and distribution of their electrons.
- The Periodic Table therefore illustrates the chemical properties of the elements.

Physics

- Physicists are interested in the nucleus because the number and distribution of protons and neutrons determines the radioactive properties of the different nuclides.
- The **Chart of the Nuclides** organizes the various nuclides according to the number and distribution of their protons and neutrons.
- The Chart of the Nuclides therefore illustrates the radioactive properties of the nuclides.

Chart of the Nuclides

- Over the years there have been a number of different versions of the chart. Today, the only version that is likely to be encountered is that developed by Emilio Segre. In fact, it used to be known as the Segre Chart.
- This chart is a checkerboard. The rows indicate the atomic number (number of protons). The columns indicate the neutron number. Each block represents a different nuclide.
- The following illustrates the lower left hand corner of the chart.

Chart of the Nuclides

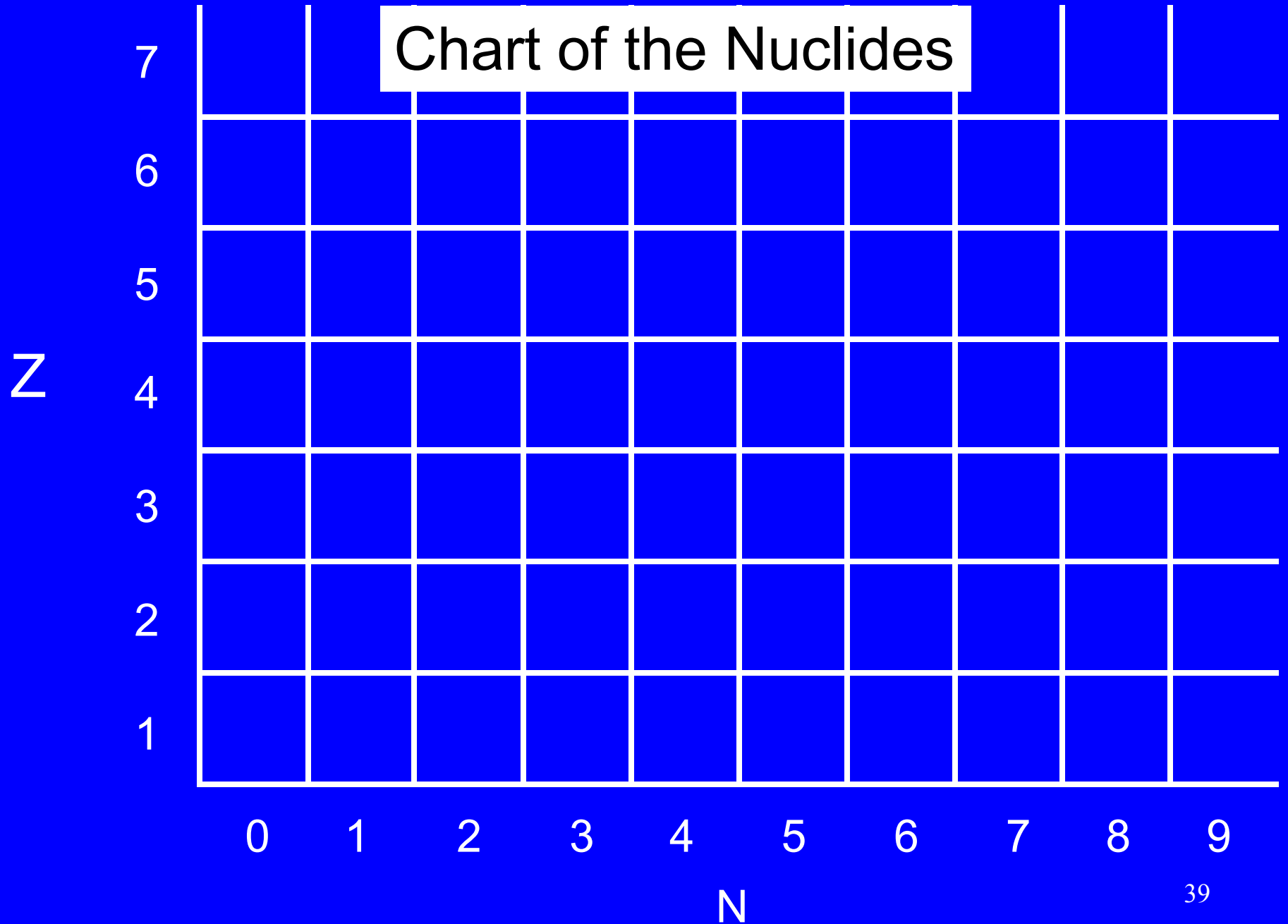

Chart of the Nuclides

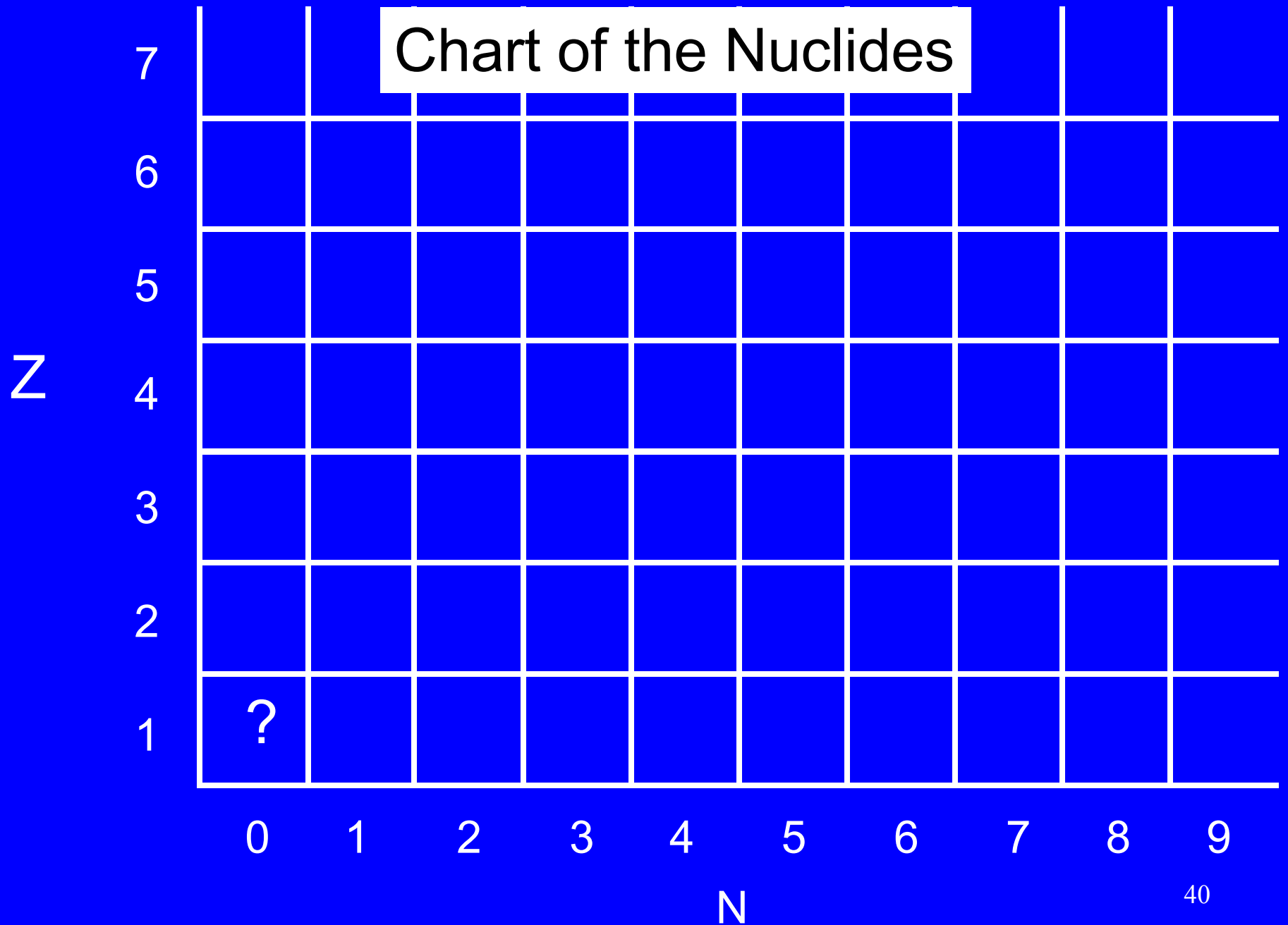

Chart of the Nuclides

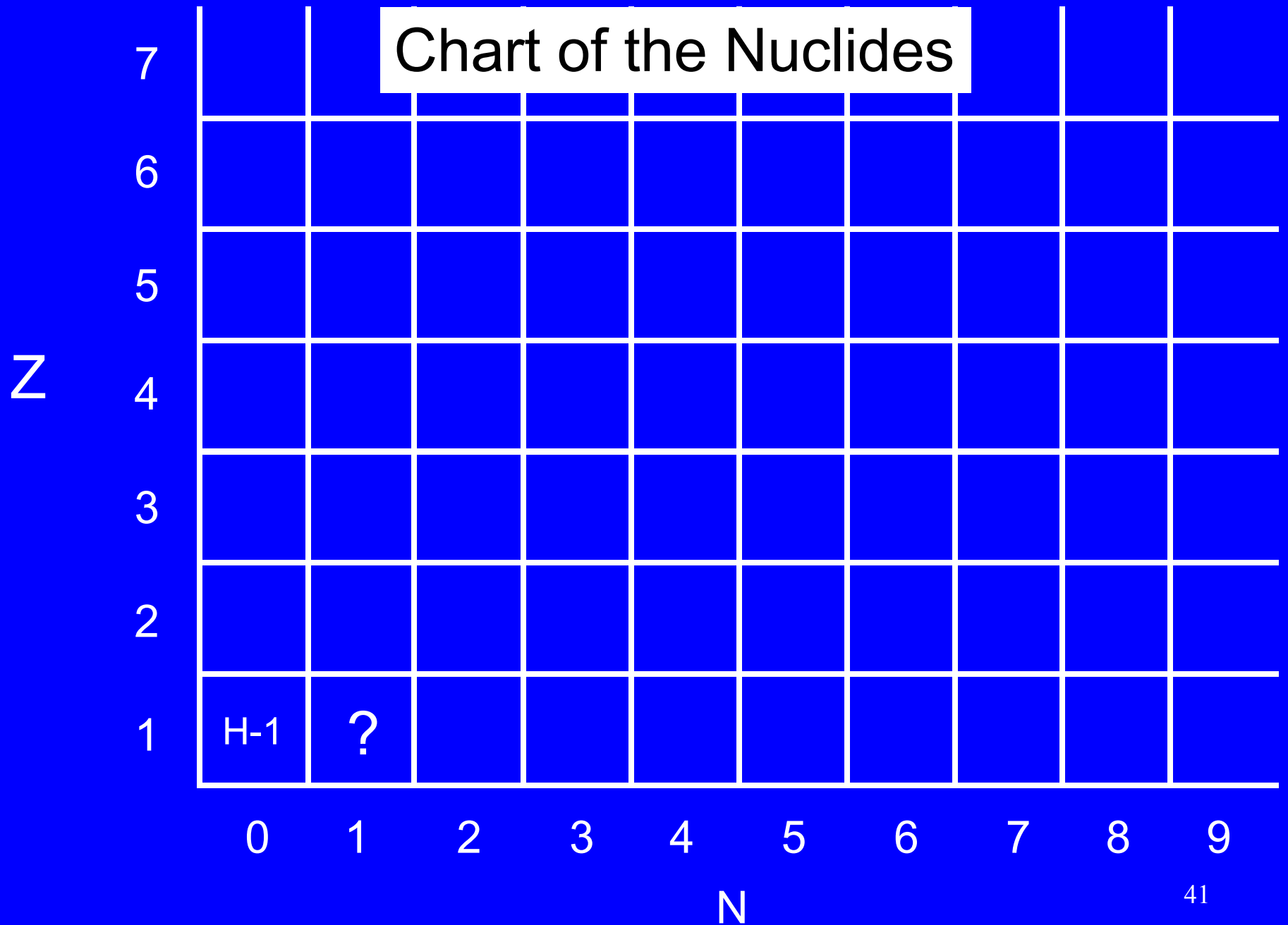

Chart of the Nuclides

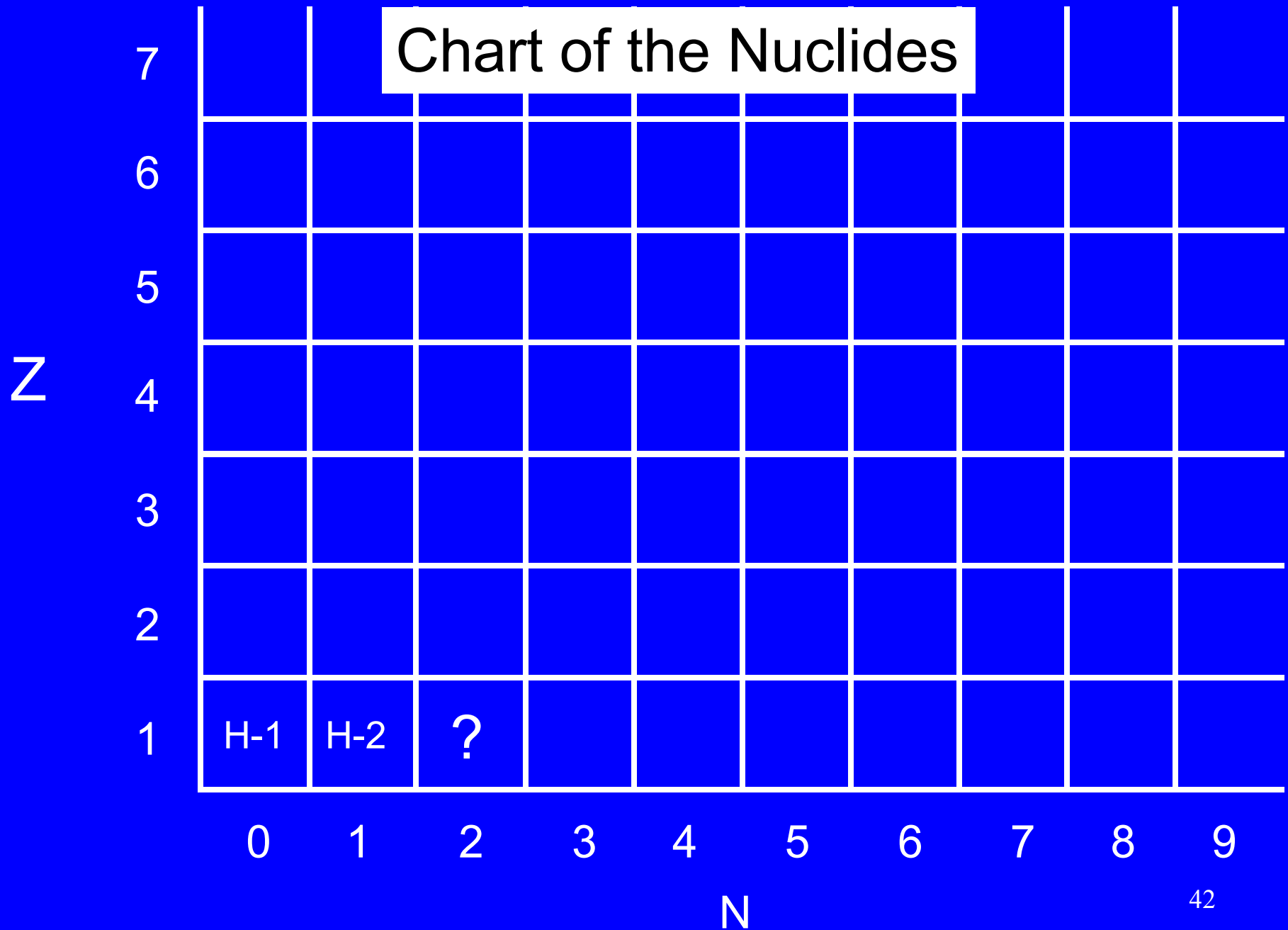

Chart of the Nuclides

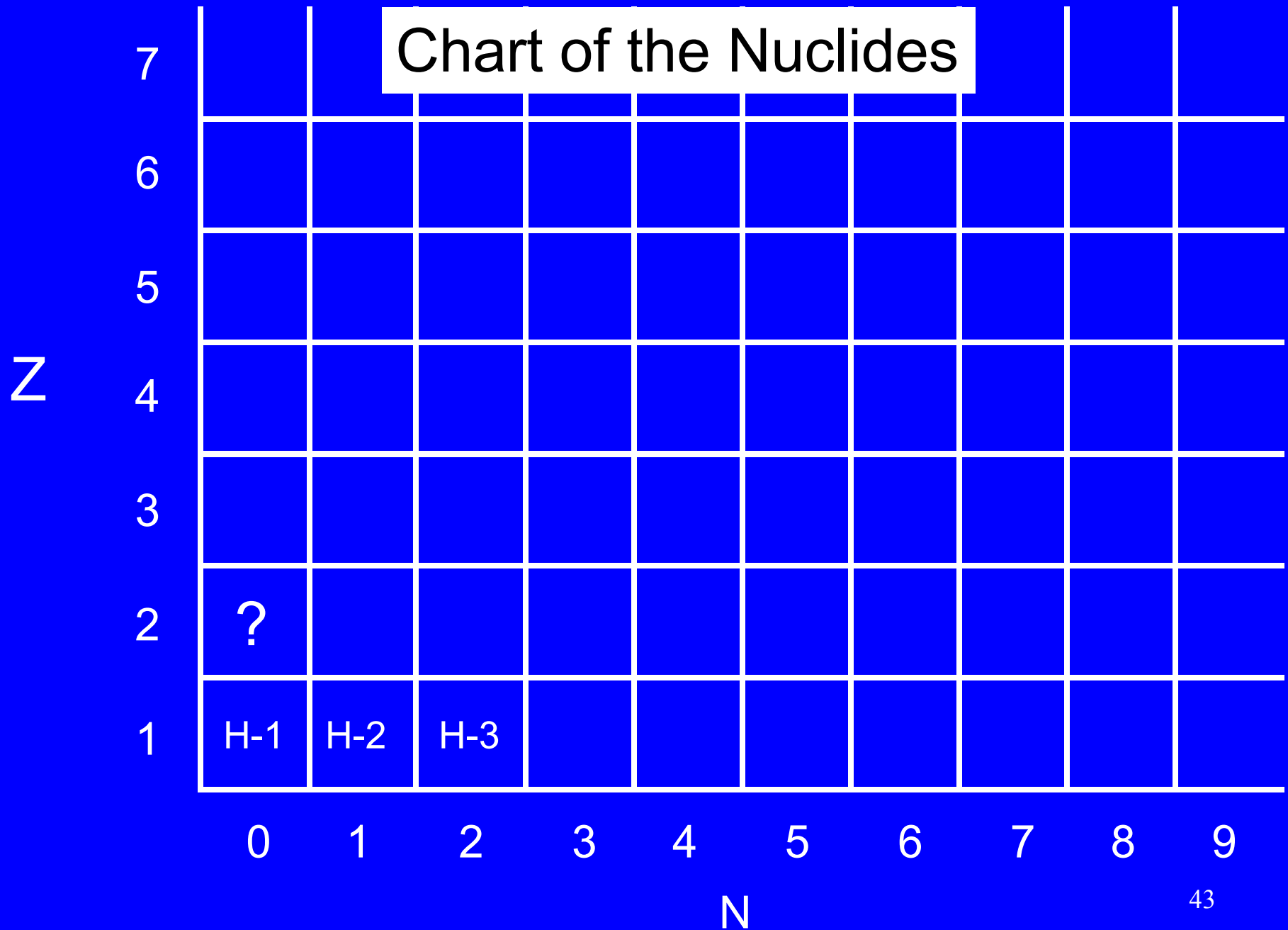

Chart of the Nuclides

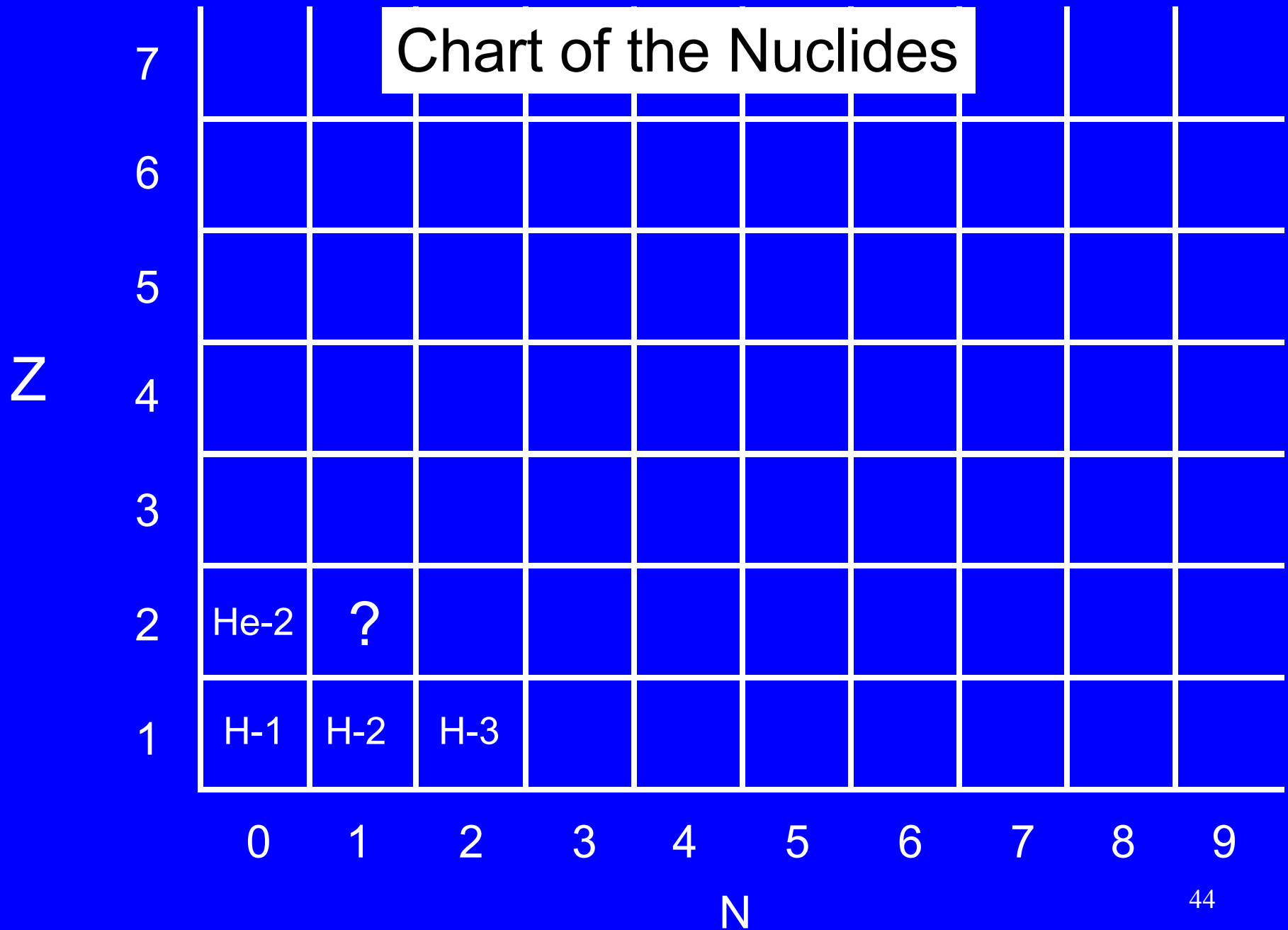

Chart of the Nuclides

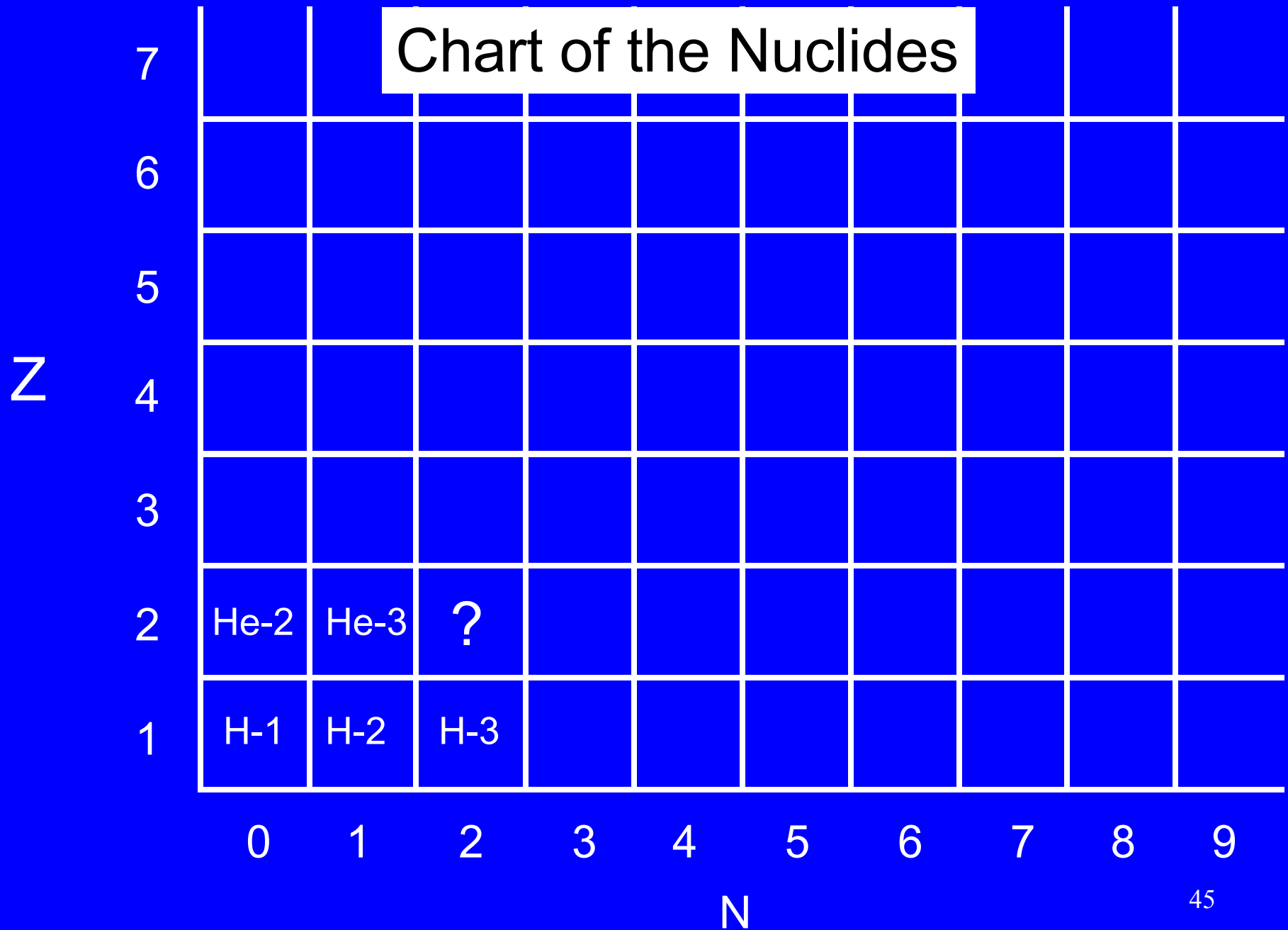

Chart of the Nuclides

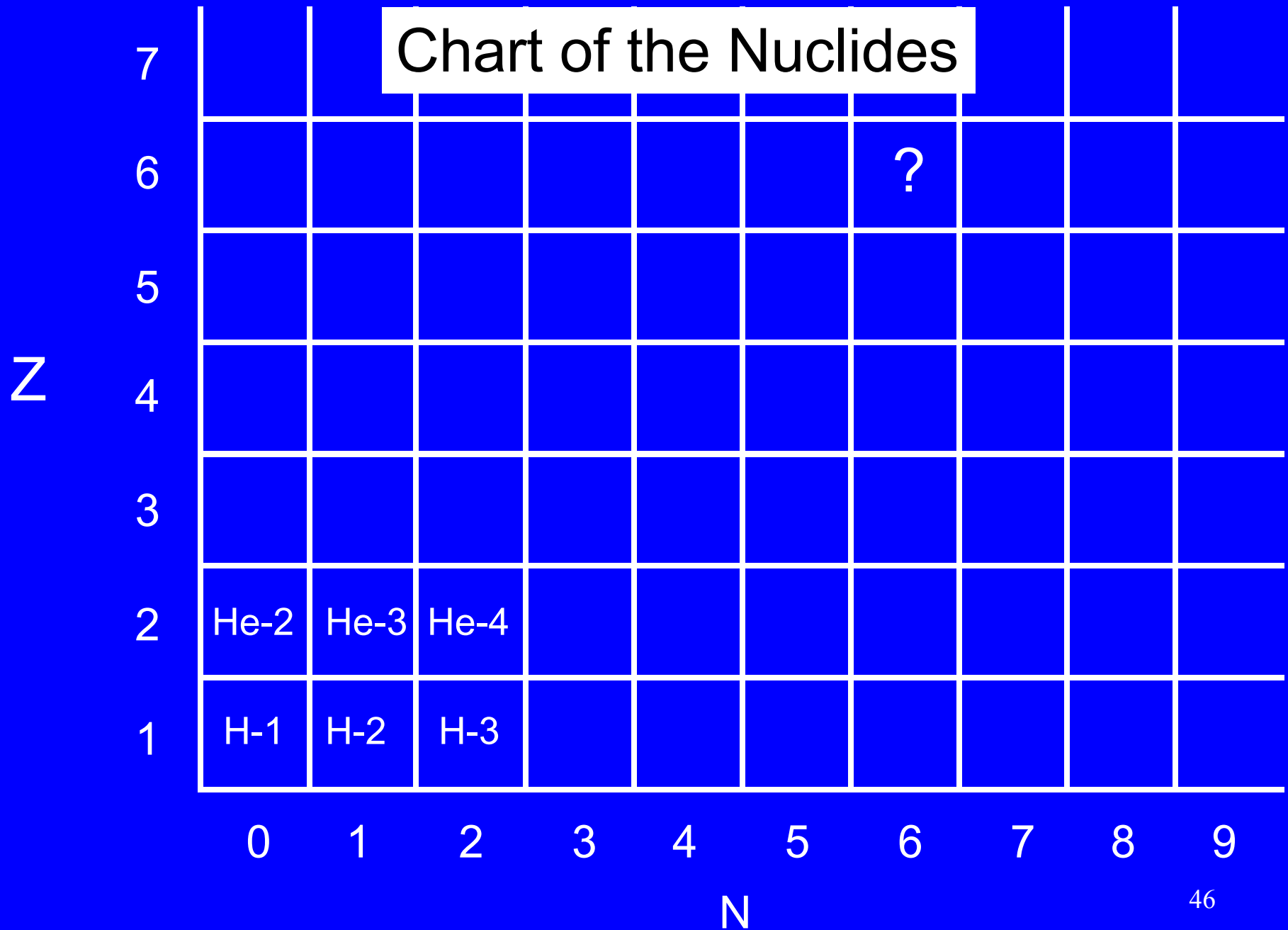

Chart of the Nuclides

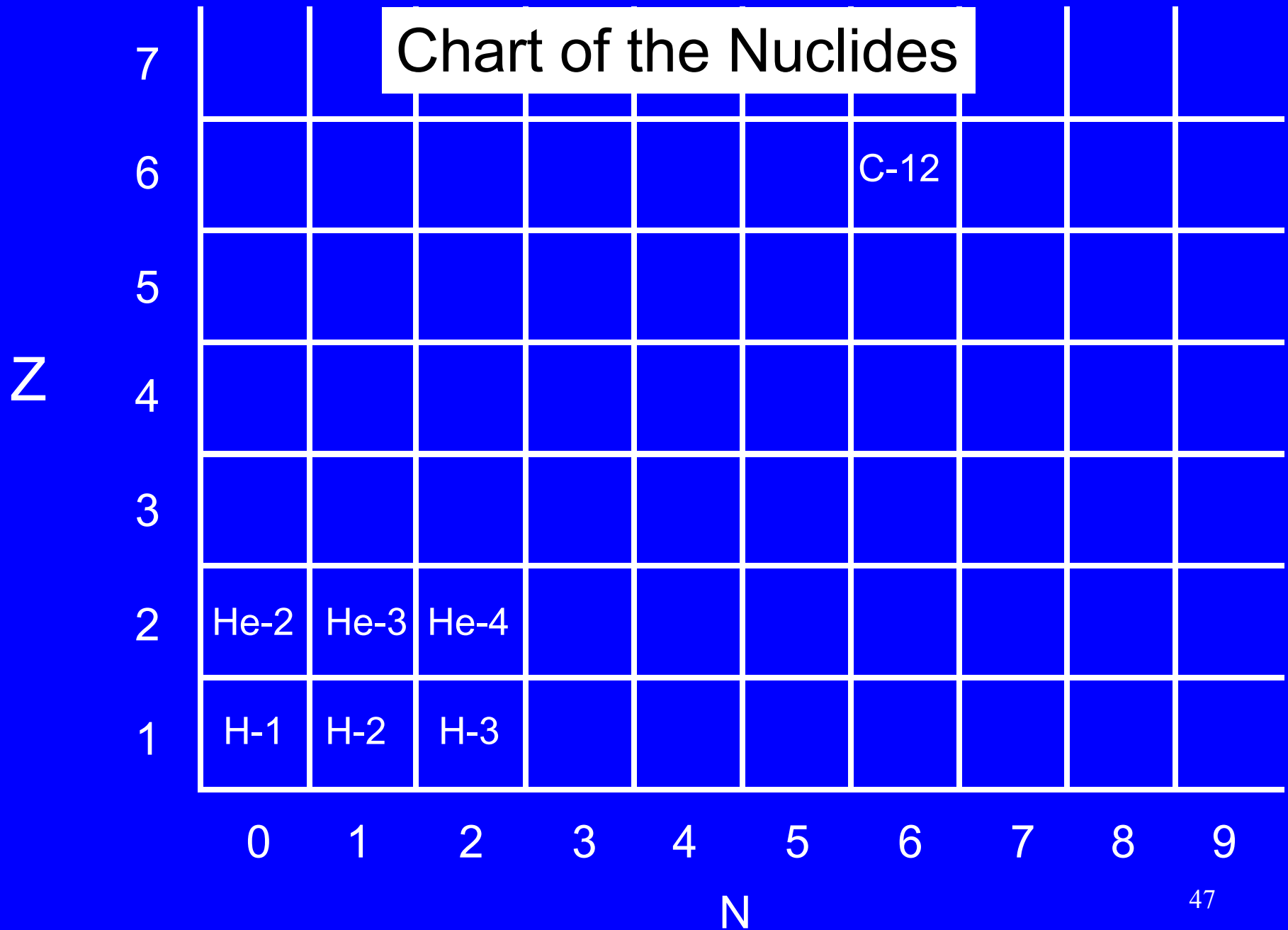
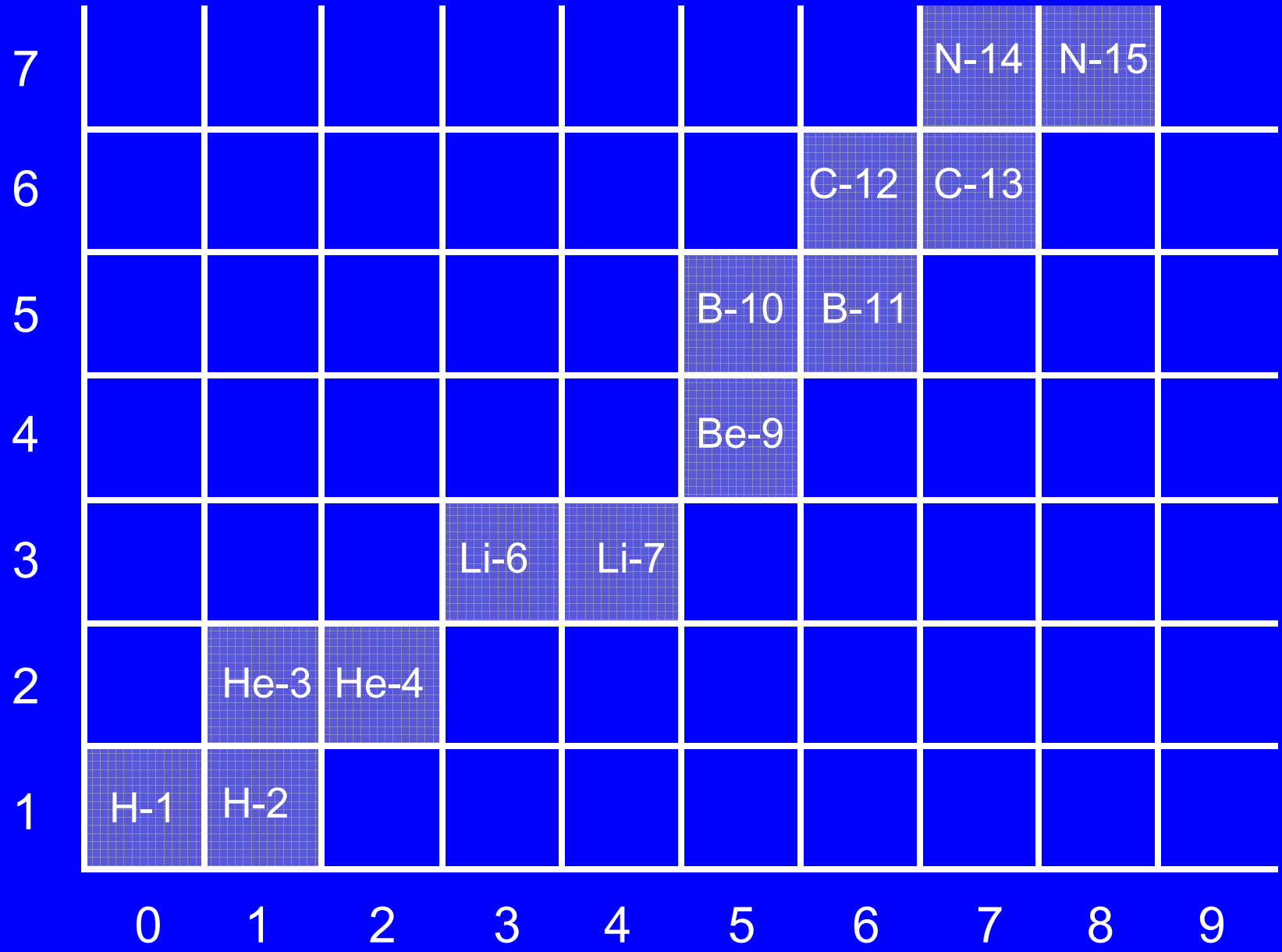

Chart of the Nuclides

- The most basic thing that the chart does is to distinguish the stable nuclides from the radionuclides by the use of color.
- The stable nuclides are colored gray - or at least some part of the block is colored gray.
- Other colors are used to indicate other characteristics of the nuclides, but they can be ignored.

Z



N

Chart of the Nuclides

- The stable nuclides are arranged so that they form a gray line called the Line of Stability

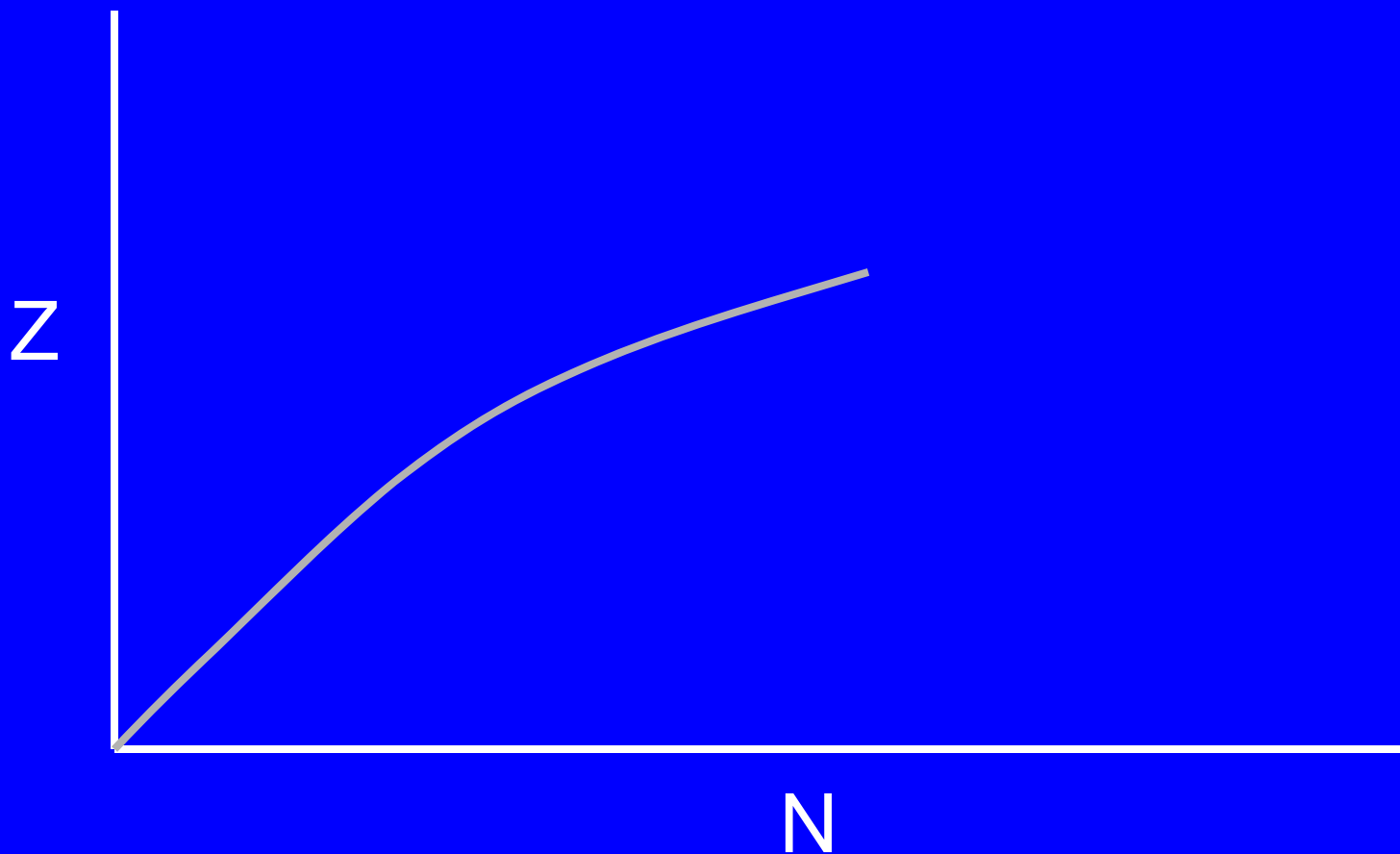

Z

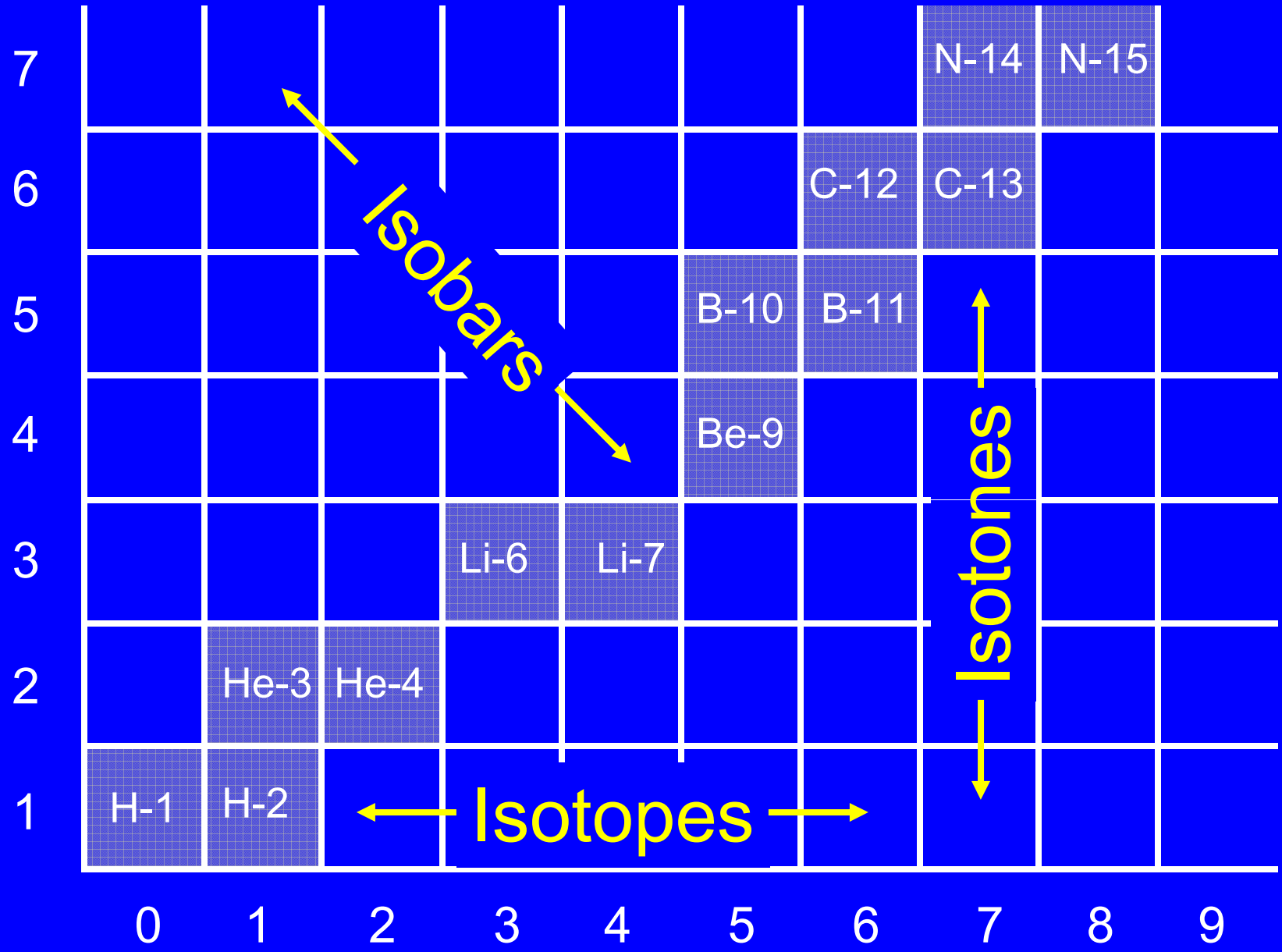

N

CHARACTERISTICS OF STABLE NUCLIDES

Common Characteristics of Stable Nuclides

1. Atomic Number Must be ≤ 83

There are radionuclides for every element but only those elements with 83 or fewer protons have stable nuclides.

Protons in the nucleus repel each other by the electromagnetic force. This destabilizes the nucleus. Neutrons help overcome this repulsion because they attract each other and they attract the protons in the nucleus by the **strong force**.

Common Characteristics of Stable Nuclides

1. Atomic Number Must be ≤ 83

Protons on opposite sides of a large nucleus repel each other because the electromagnetic force is exerted over large distances.

However, the strong force only operates over very short distances within the nucleus.

As a result, the number of neutrons needed for stability increases faster than the atomic number - the greater the atomic number, the greater the neutron to proton ratio must be for stability.

Common Characteristics of Stable Nuclides

1. Atomic Number Must be ≤ 83

It is expected that as yet undiscovered very high atomic number elements will possess stable nuclides and form an “island of stability.”

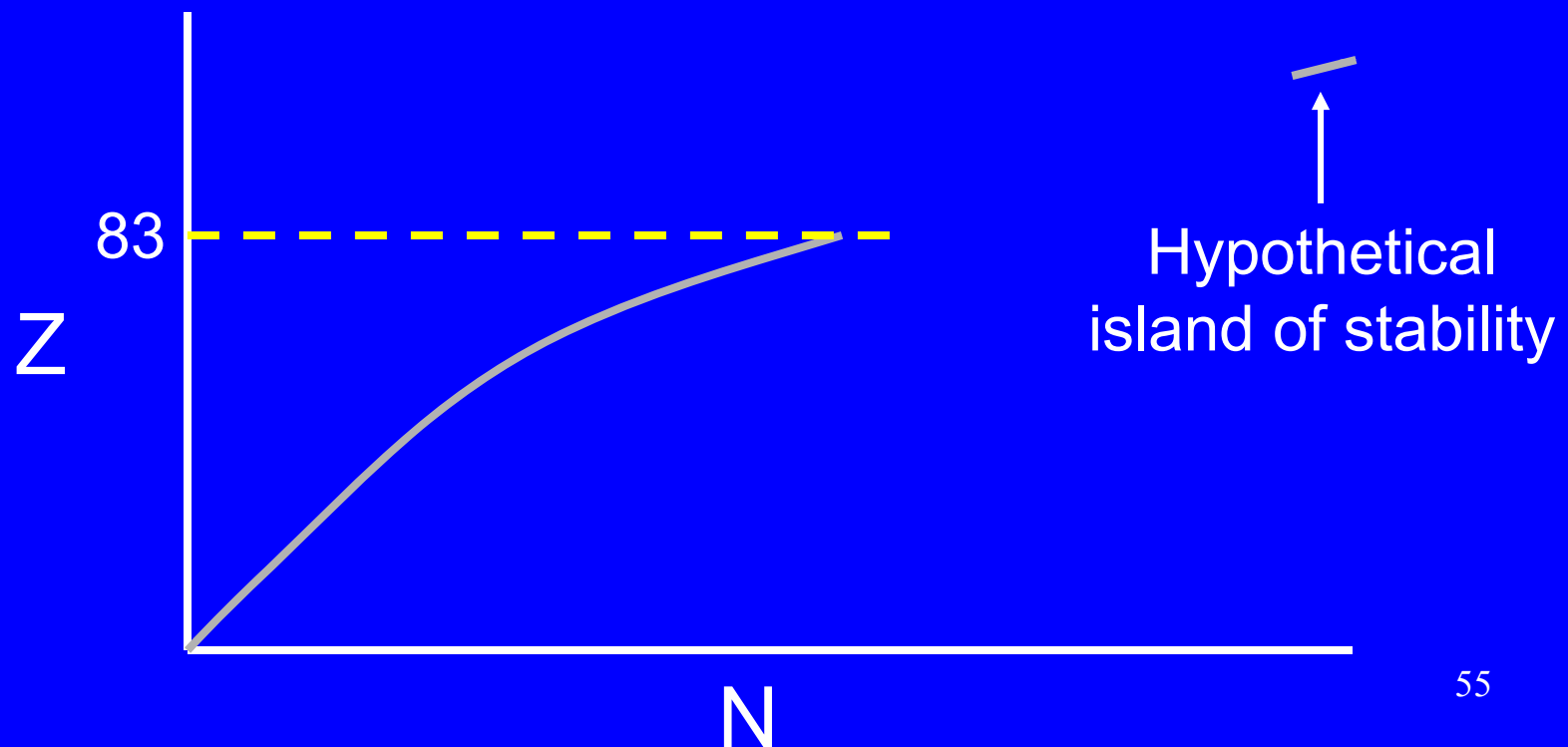

Common Characteristics of Stable Nuclides

2. Stable Nuclides with Small Atomic Numbers tend to have Equal Numbers of Protons and Neutrons

e.g., H-2, He-4, Li-6, B-10, C-12, N-14, O-16.

Stable Nuclides with High Atomic Numbers tend to have More Neutrons than Protons

e.g., Pb-206, 82 protons and 124 neutrons.

Common Characteristics of Stable Nuclides

3. Stable Nuclides tend to have an Even Number of Protons and/or an Even Number of Neutrons

There are 266 known stable nuclides.

159	Even Z	Even N
53	Even Z	Odd N
50	Odd Z	Even N
4	Odd Z	Odd N

Common Characteristics of Stable Nuclides

3. Stable Nuclides Tend to have an Even Number of Protons and an Even Number of Neutrons

The neutrons in the nucleus pair up - one spinning in one direction and the other spinning in the opposite direction.

If there is an even number of neutrons, they can all pair up.

Similarly, the protons in the nucleus pair up with each other.

Common Characteristics of Stable Nuclides

4. Magic Numbers

Certain numbers of neutrons and protons are particularly stable. These “magic numbers” are the same for neutrons and protons. All the magic numbers are even. They are:

2, 8, 20, 28, 50, 82, 126.

On the chart of the nuclides, the magic numbers are bounded with extra heavy lines.

Chart of the Nuclides

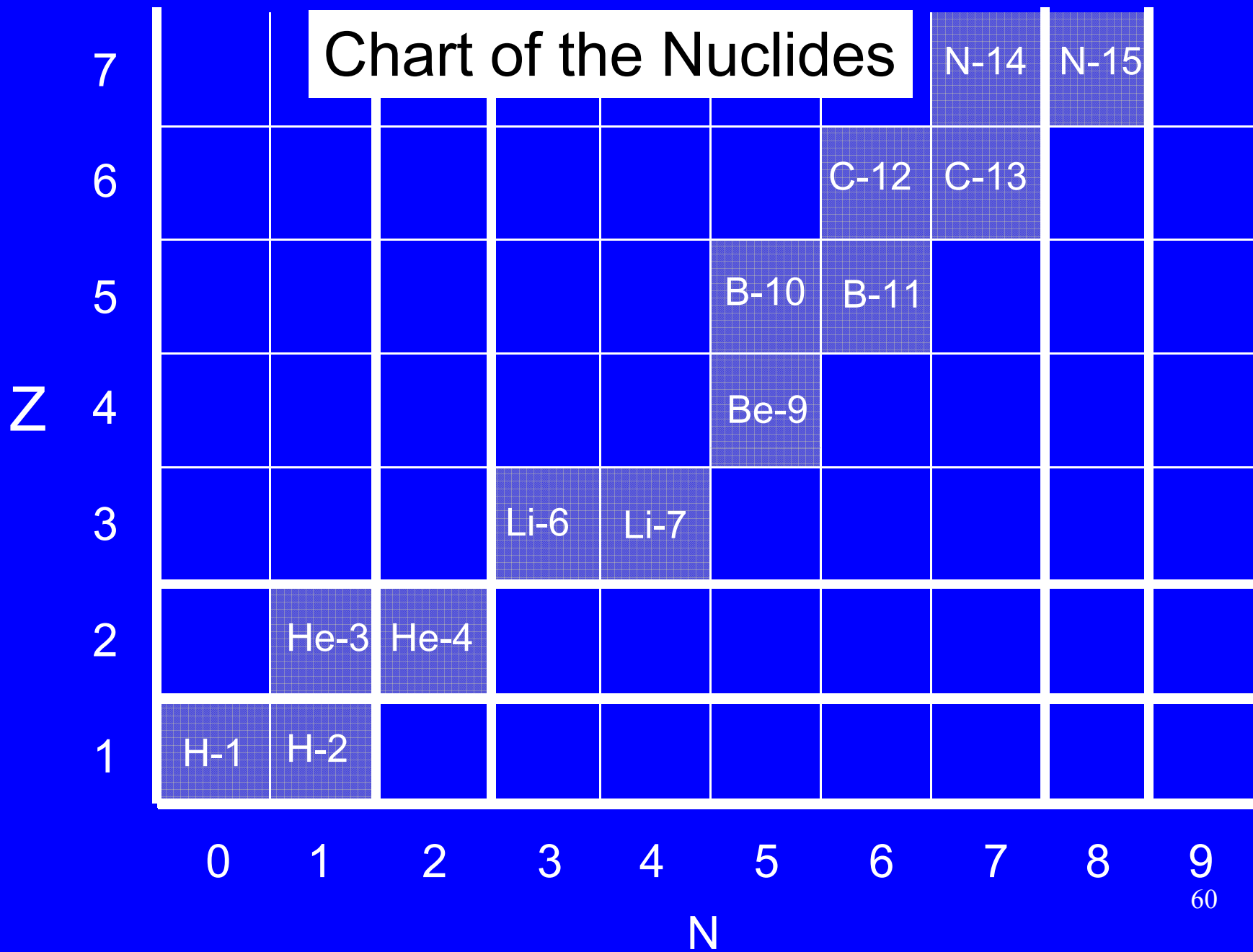

Common Characteristics of Stable Nuclides

4. Magic Numbers

Like the electrons of an atom, the neutrons in the nucleus exist in different energy levels. These energy levels are referred to as shells.

The magic numbers are the numbers of neutrons required to fill the neutron shells and the number of protons required to fill the proton shells.

When the shells are filled, the nucleus has an extra degree of stability - analogous to the atomic stability associated with filled electron shells.

RADIOACTIVE DECAY

Radioactive Decay

- Radionuclides undergo a process referred to as decay (also referred to as transformation or transition).
- During decay, a radionuclide changes its number of protons and its number of neutrons to a more stable combination - it becomes a different nuclide.
- In the process, some mass is converted to energy. This energy is carried off by the products of the decay. The products of the decay that carry energy are referred to as radiation.

Radioactive Decay

- Decay represents movement towards the line of stability on the chart of the nuclides.

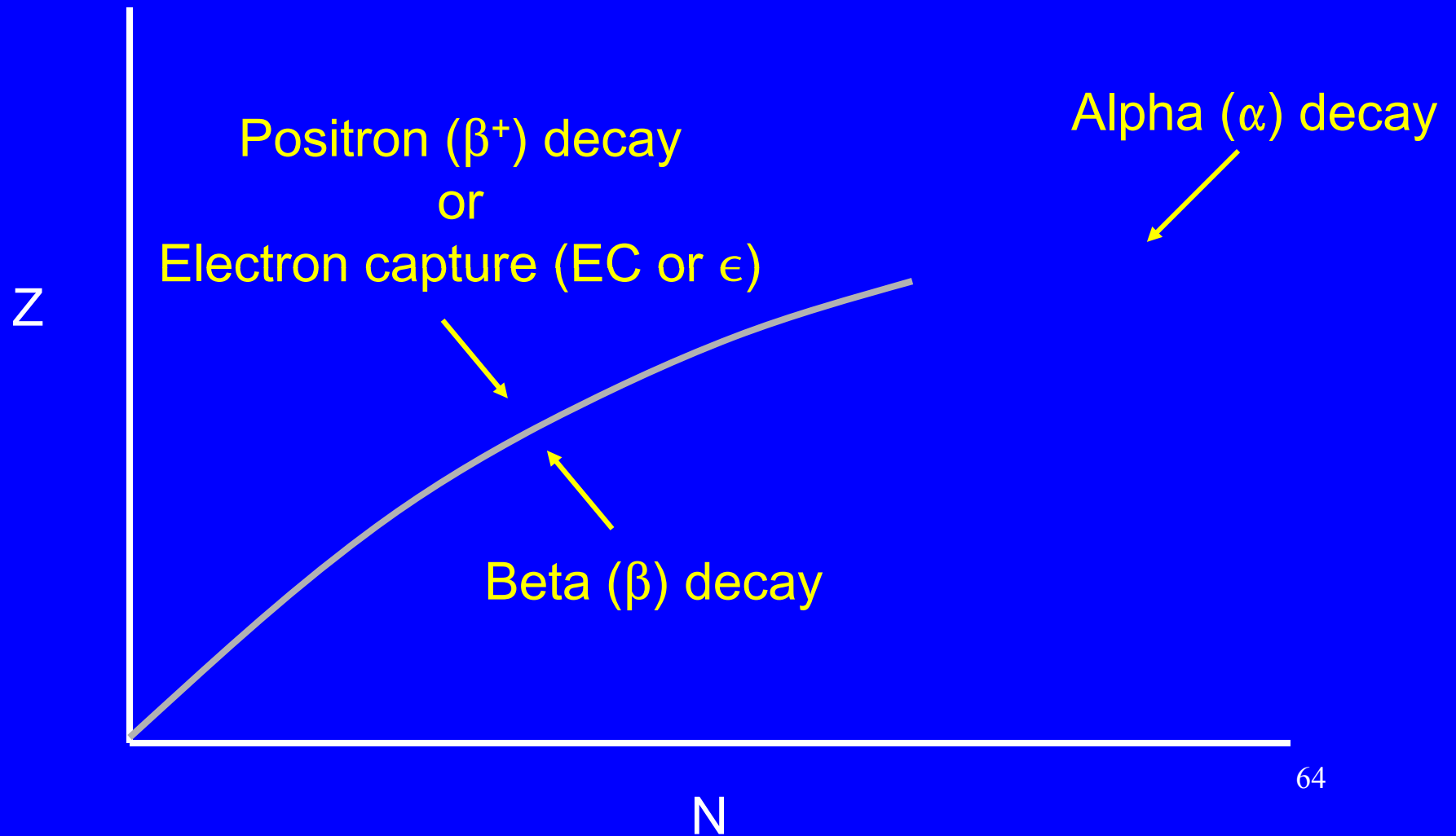

Radioactive Decay

- Other less common processes accomplish the same things, e.g.:

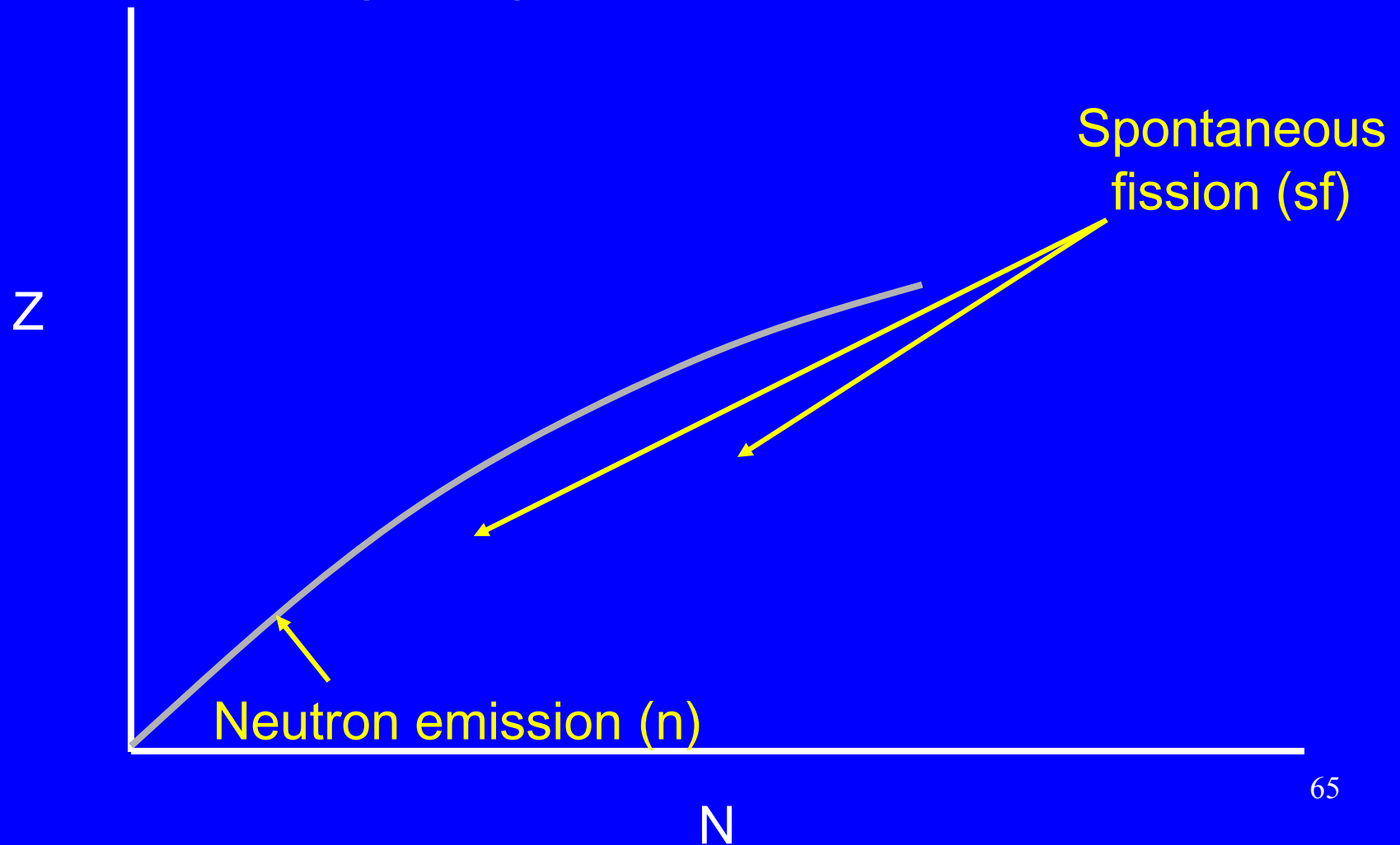

Radioactive Decay

- Sources of radionuclides:

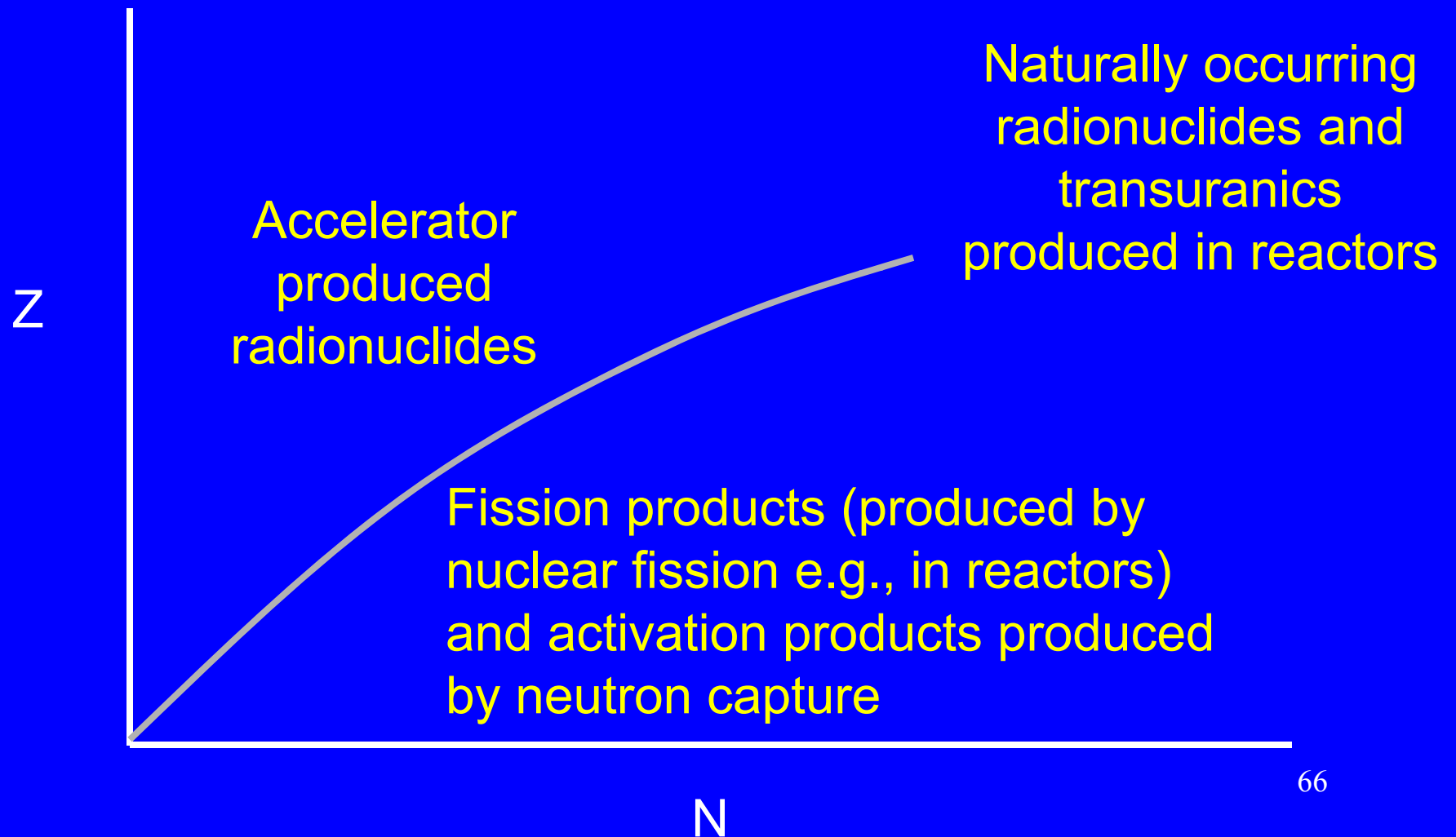

MAJOR TYPES OF DECAY:

BETA DECAY

ALPHA DECAY

POSITRON DECAY

ELECTRON CAPTURE

BETA DECAY

Beta Decay

- A beta particle is an electron “born” in the nucleus
- Beta emission is characteristic of nuclides below the line of stability - they have too many neutrons to be stable.
- In beta decay a neutron is converted into a proton (a down quark is converted into an up quark).
- In beta decay an antineutrino is also produced ($\bar{\nu}$).

Beta Decay

- A neutrino, like an electron, is a point particle. It has no charge. Any mass that it might have is extremely small. Although a neutrino or antineutrino can possess considerable energy, this is not a concern because they are unlikely to transfer this energy to the matter they travel through.
- For the purpose of radiation protection, neutrinos and antineutrinos can be ignored.

Beta Decay

- In beta decay, a parent radionuclide decays into a decay product (daughter), a beta particle, and an antineutrino:



- The energy released in the decay process is distributed between these decay products.

Beta Decay



- In pure beta decay (no gamma emission), the energy given to the decay products takes the form of kinetic energy.
- This energy can be distributed between the three products in an infinite variety of ways.
- As an average, the beta particle gets 1/3 of the energy and the antineutrino gets 2/3 of the energy. The recoil decay product gets sufficiently little energy that it is usually ignored.

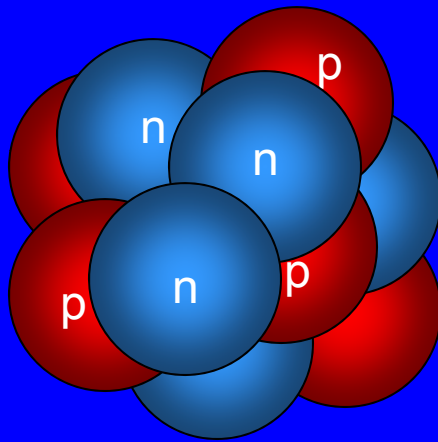

Parent Radionuclide

↑
● Beta

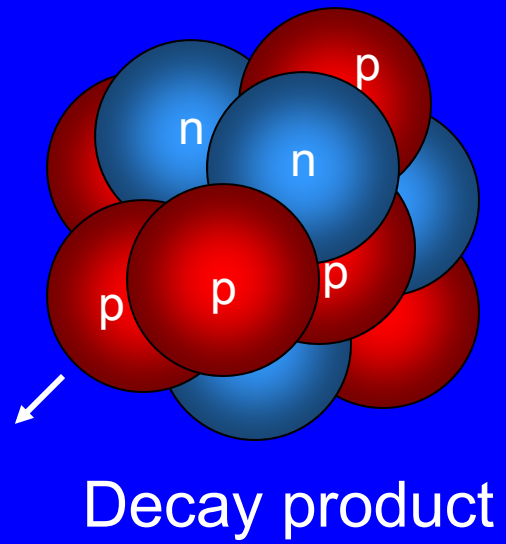

Antineutrino

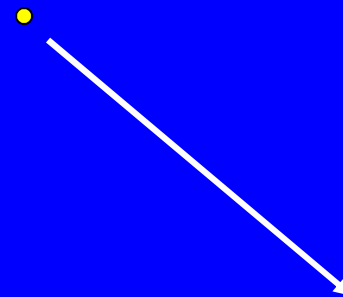

Beta Decay



- When the beta particle energy of a radionuclide is referred to, it is usually done by specifying the maximum kinetic energy that the beta particle could have (i.e., the antineutrino gets no energy).
- Sometimes the average energy is specified. The average beta energy is approximately 1/3 the maximum.
- Keep in mind that a “high energy beta emitter” emits many very low energy beta particles.

Beta Decay

- A typical beta spectrum:

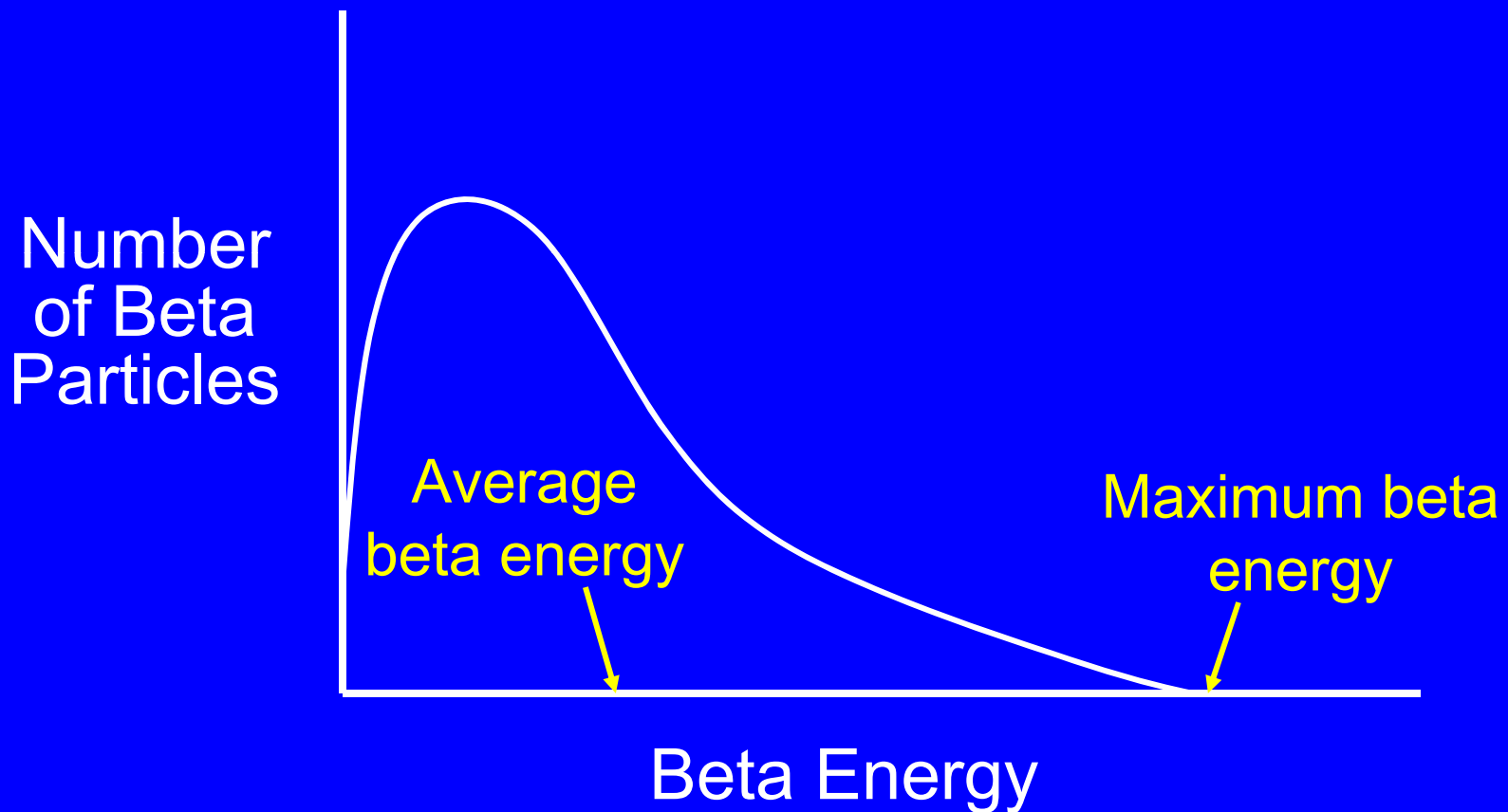

Beta Decay

Example:



- Phosphorous-32 (15 protons and 17 neutrons) decays into the stable nuclide sulfur-32 (16 protons and 16 neutrons).
- P-32 is a high energy beta emitter (1.71 MeV maximum).

Beta Decay

- On the chart of the nuclides, beta decay results in moving diagonally one up to the left - a loss of one neutron and an increase of one proton.

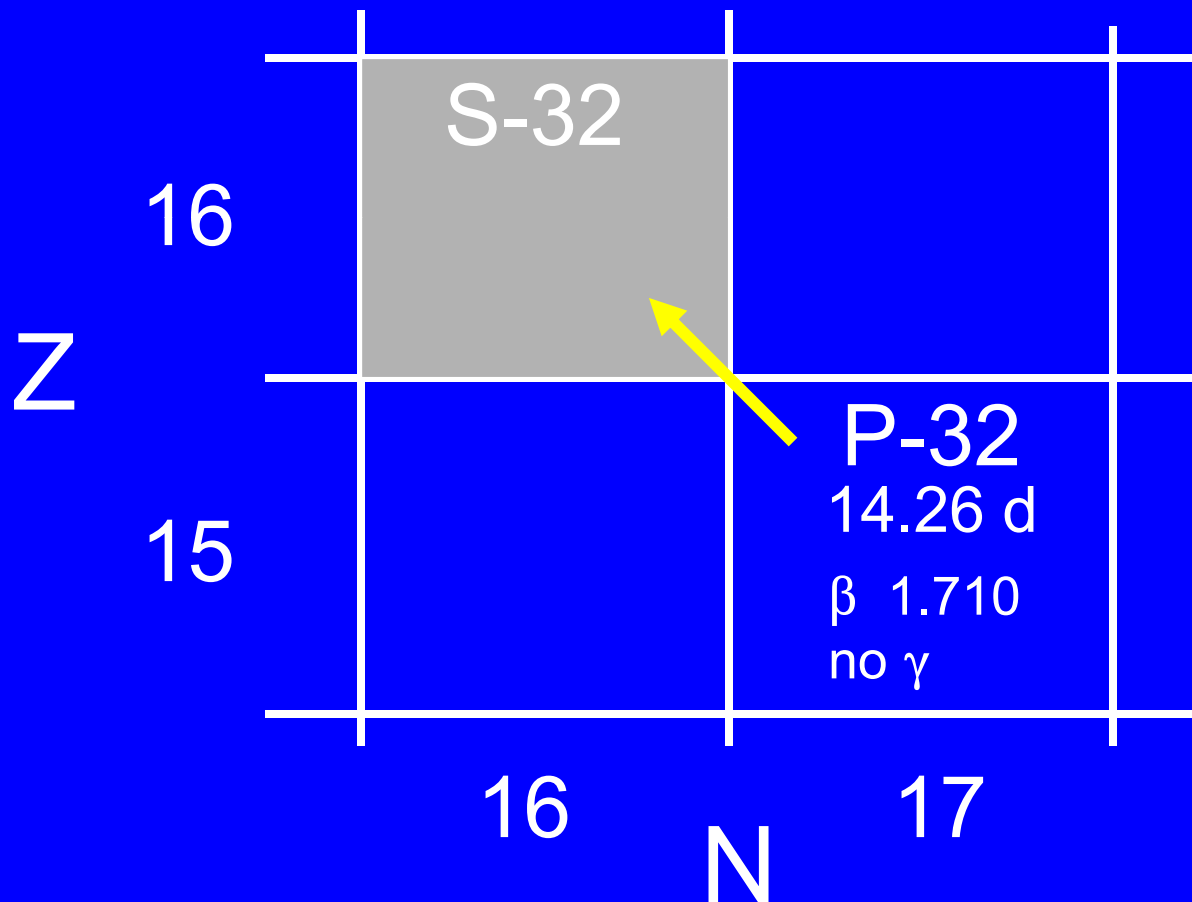

Beta Decay

- It is also common to depict radioactive decay as a decrease in energy as follows:

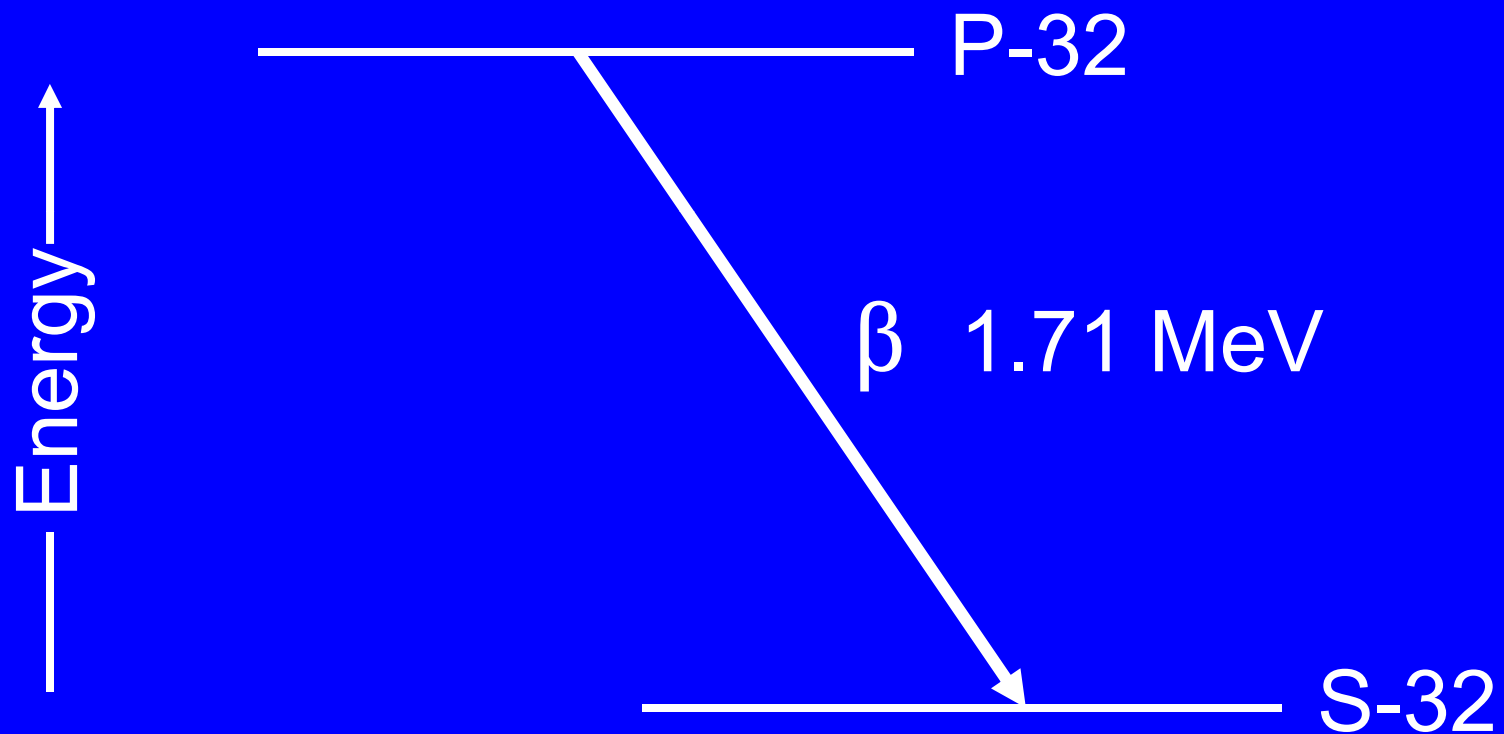

ALPHA DECAY

Alpha Decay

- An alpha particle is a helium-4 nucleus (two protons and two neutrons). It is sometimes symbolized as follows



- Alpha decay is characteristic of nuclides with atomic numbers greater than 83. For example, nuclides of high Z elements such as polonium, radium, uranium, thorium and plutonium, tend to be alpha emitters. They have too many protons to be stable.

Alpha Decay

- There are exceptions. A few alpha emitters have atomic numbers less than 83 (e.g., Gd-148), and there are many beta emitters with atomic numbers greater than 83 (e.g., Ra-228, Pu-241).

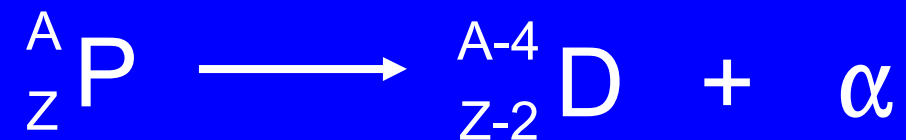

- The kinetic energy released in the decay process is distributed between the decay product and the alpha particle. There is no neutrino.

Alpha Decay

- In pure alpha decay (no gamma emission), the energy given to the products of the decay only takes the form of kinetic energy. In this case, the energy can only be distributed in one way between the alpha particle and the decay product.
- As a result, alpha particles are monoenergetic (unlike beta particles which have a range of energies up to some specific maximum). For example, all alpha particles emitted by Po-218 have a kinetic energy of 6 MeV. Only a small fraction of the beta particles emitted by P-32 have an energy of 1.7 MeV.

Alpha Decay

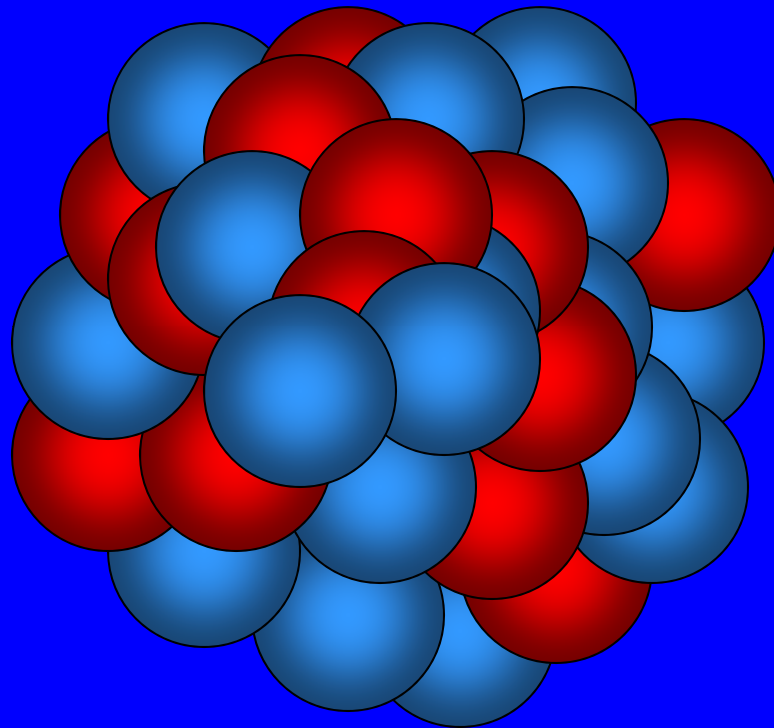

Parent Radionuclide

Alpha Decay

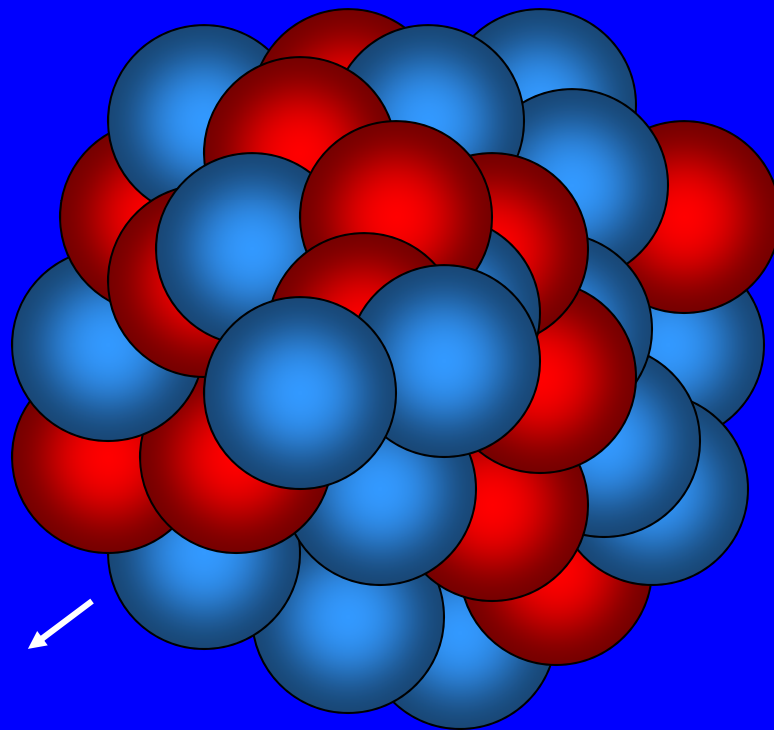

Decay Product

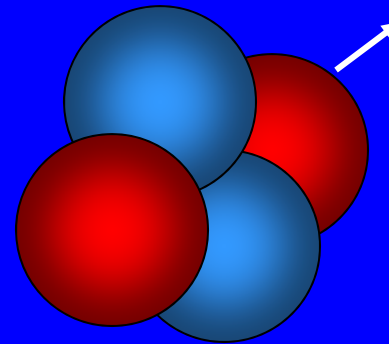

Alpha Particle

Alpha Decay

- A typical alpha spectrum:

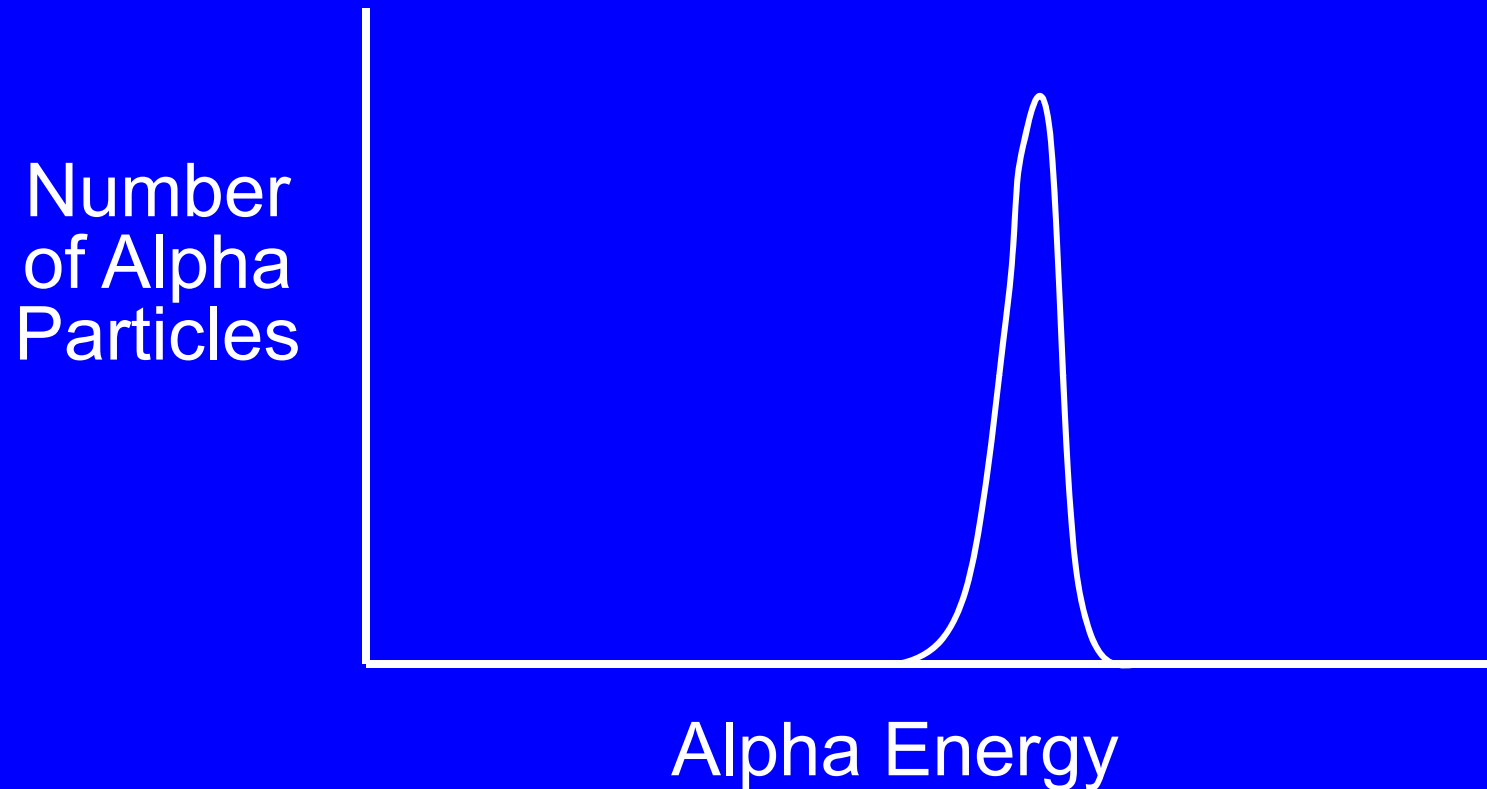

- Alpha energies typically range from 4 to 8 MeV. The shorter the half-life, the higher the energy.⁸⁶

Alpha Decay

Example:

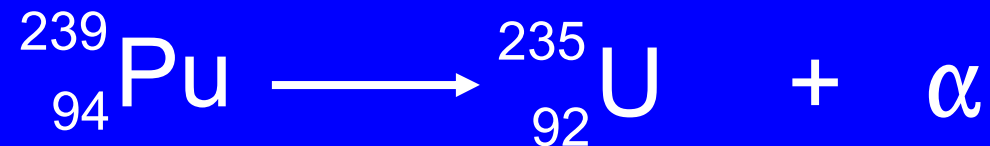

- The decay products produced in alpha decay are usually radionuclides as well (e.g., U-235).

Alpha Decay

- On the chart of the nuclides, alpha decay results in moving diagonally two down to the left - a loss of two neutrons and two protons.

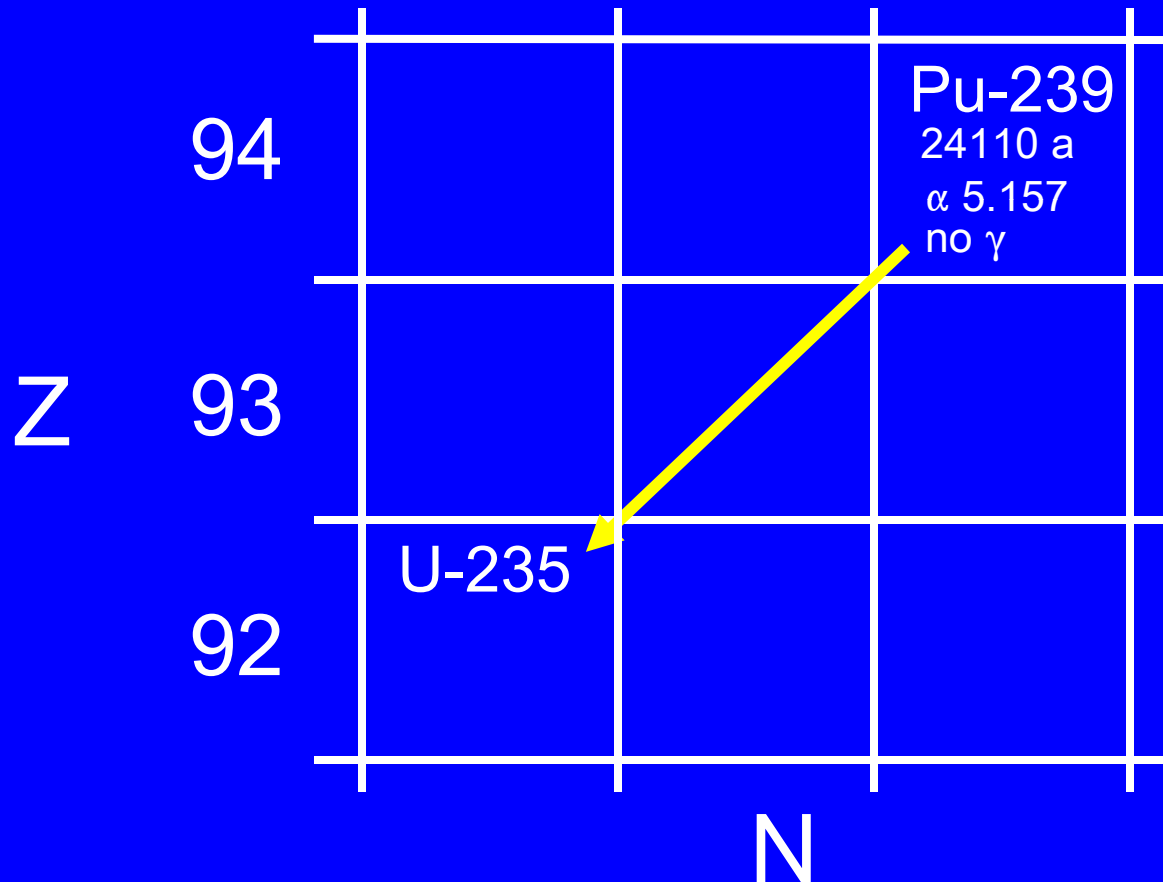

Alpha Decay

- It is common to depict alpha decay as a decrease in energy as follows:

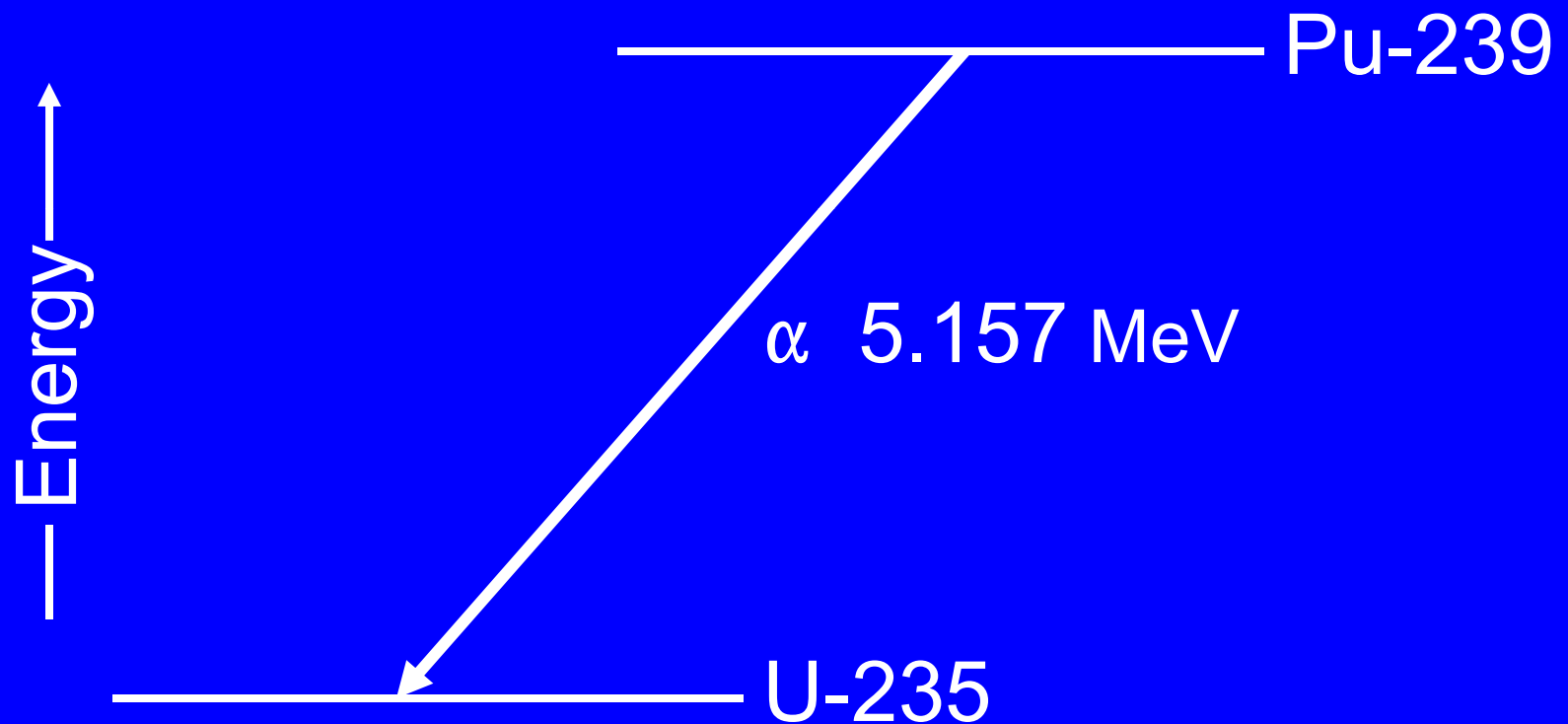

GAMMA RAY EMISSION

Gamma Ray Emission

- Gamma rays are electromagnetic radiation emitted from the nucleus when it moves to a lower energy level (x-rays are emitted by electrons when they move to a lower energy level).
- For a gamma ray to be emitted during decay, the decay product nucleus must be left in an excited state. When the decay product nucleus de-excites, a gamma ray can be emitted. This can be depicted as a two step process.

Gamma Ray Emission

Example:



It is easier to depict this two-step process as:

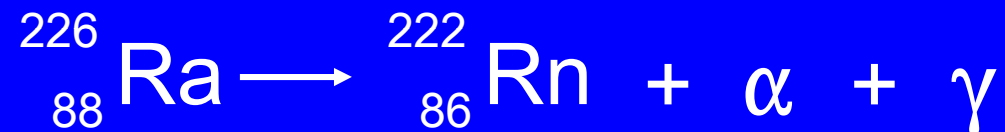

- Even though the gamma ray actually comes from the decay product nucleus (Rn-222), it is attributed to the parent nuclide (Ra-226). This is done because the gamma ray is produced at the same moment that the parent decays.

Gamma Ray Emission

- An energy diagram can also be used to depict the emission of the gamma ray:

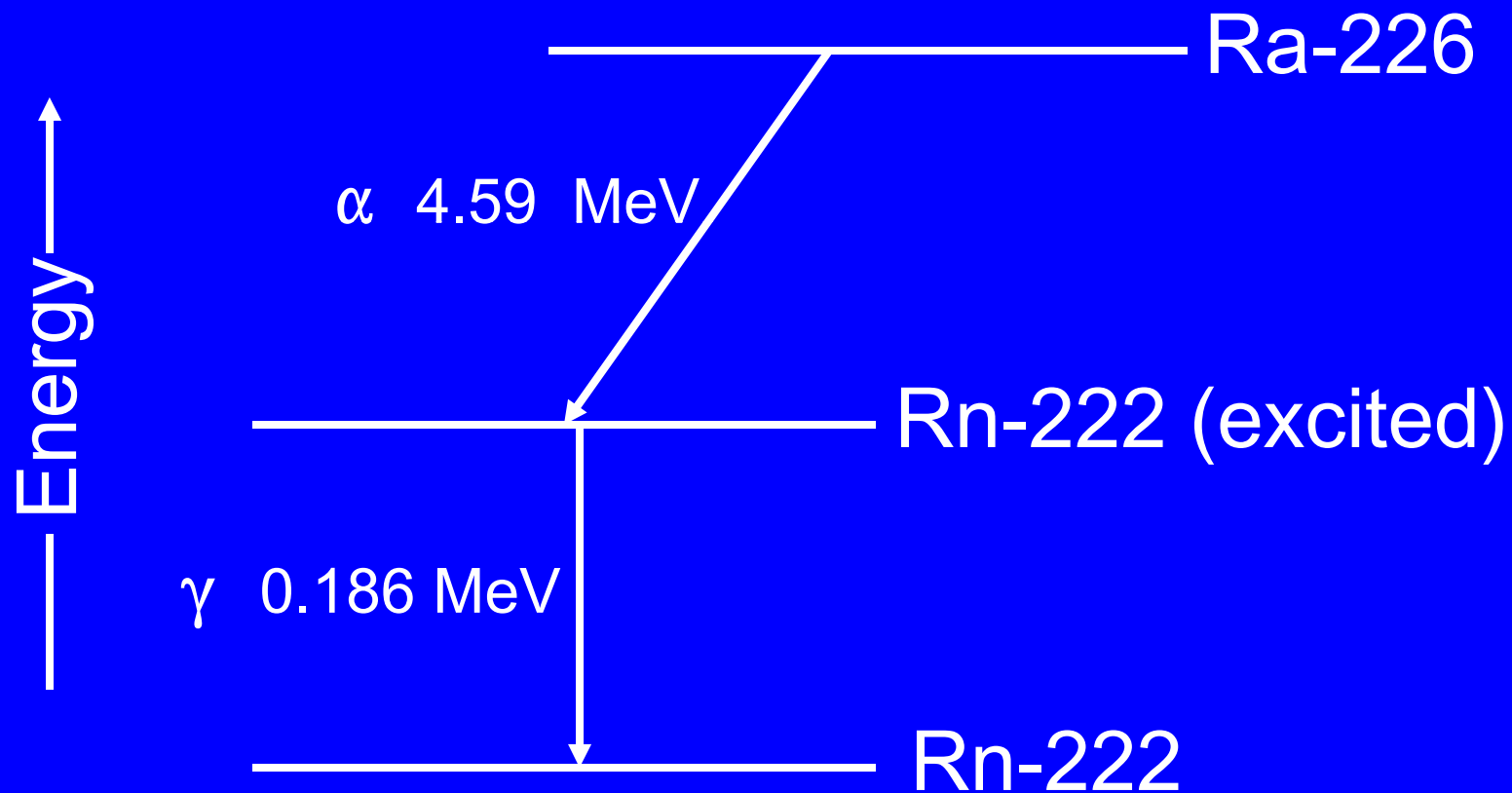

Gamma Ray Emission

- Ra-226 only emits a gamma ray in a fraction of its decays.

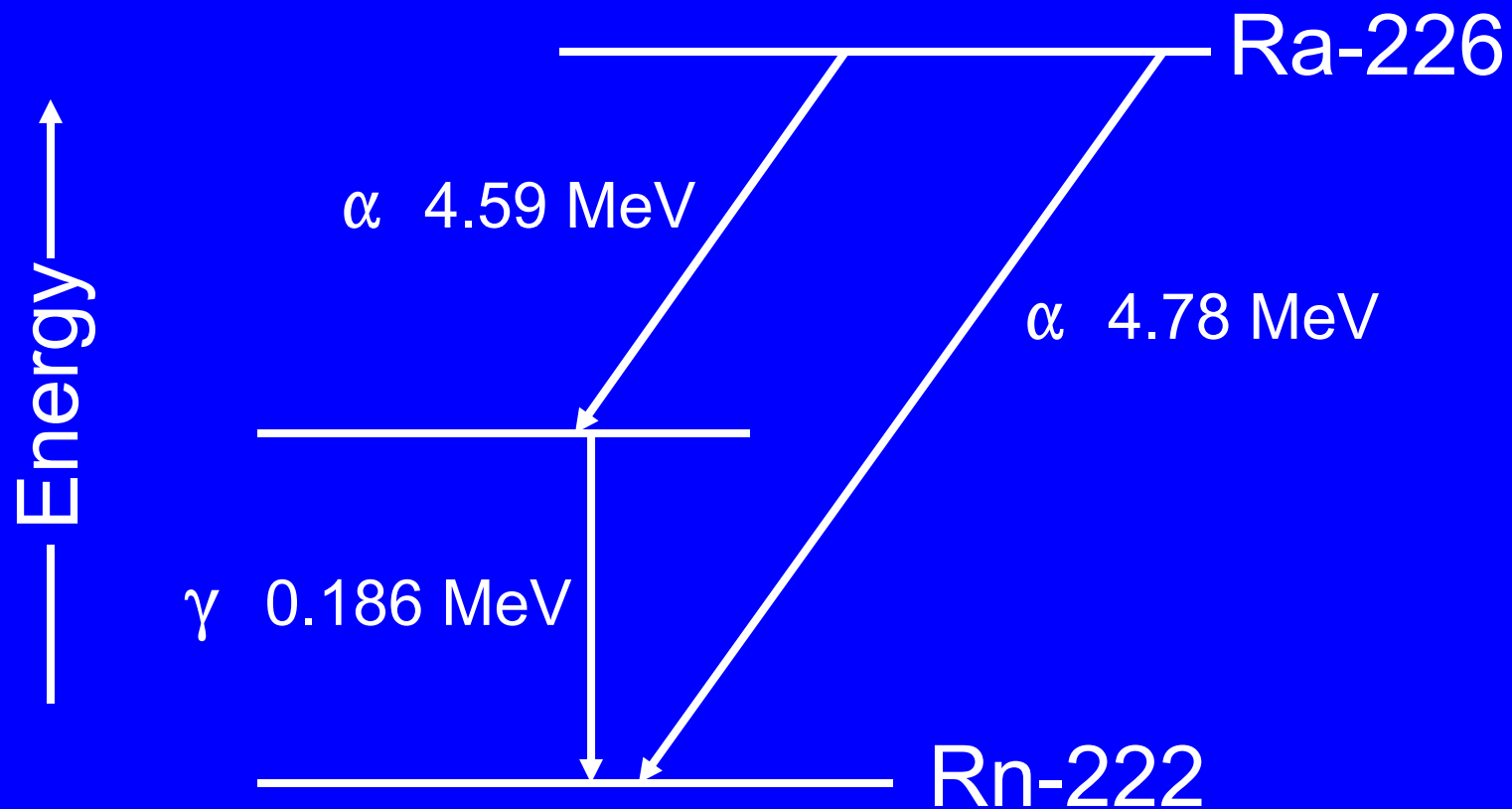

Gamma Ray Emission

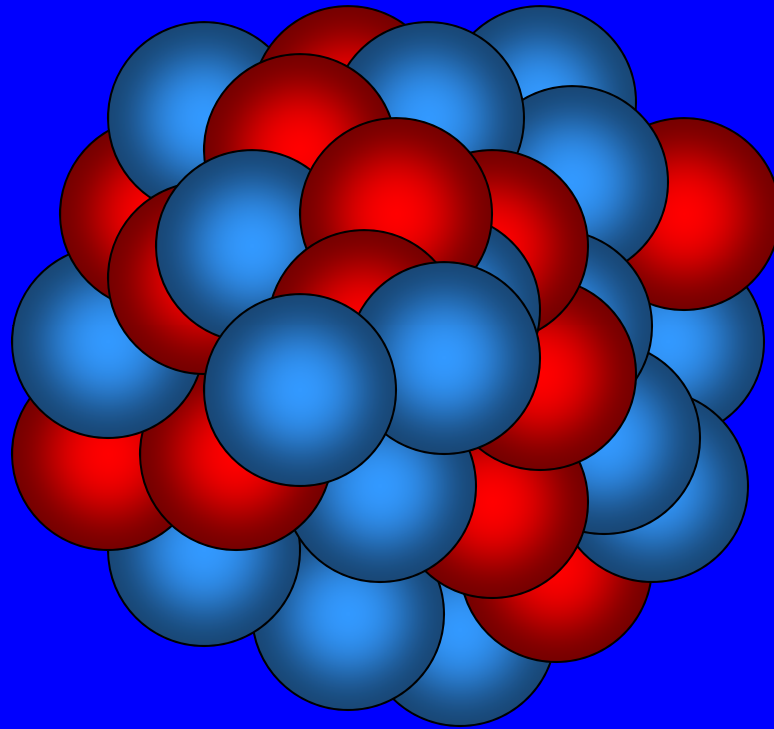

Parent Radionuclide

Gamma Ray Emission

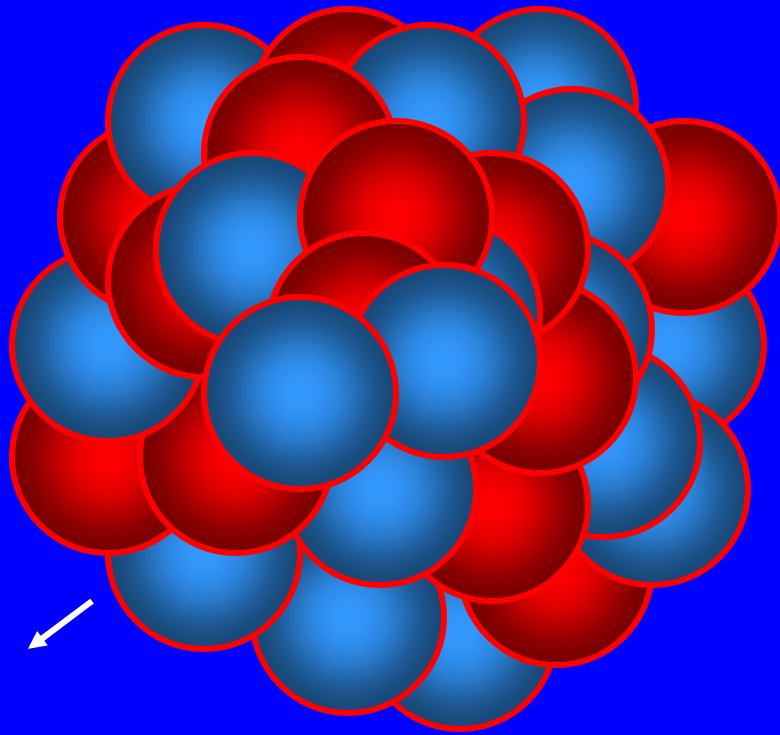

Decay Product (*Excited*)

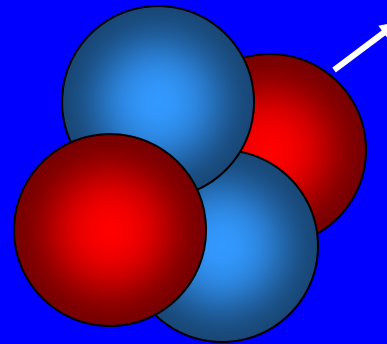

Alpha Particle

Gamma Ray Emission

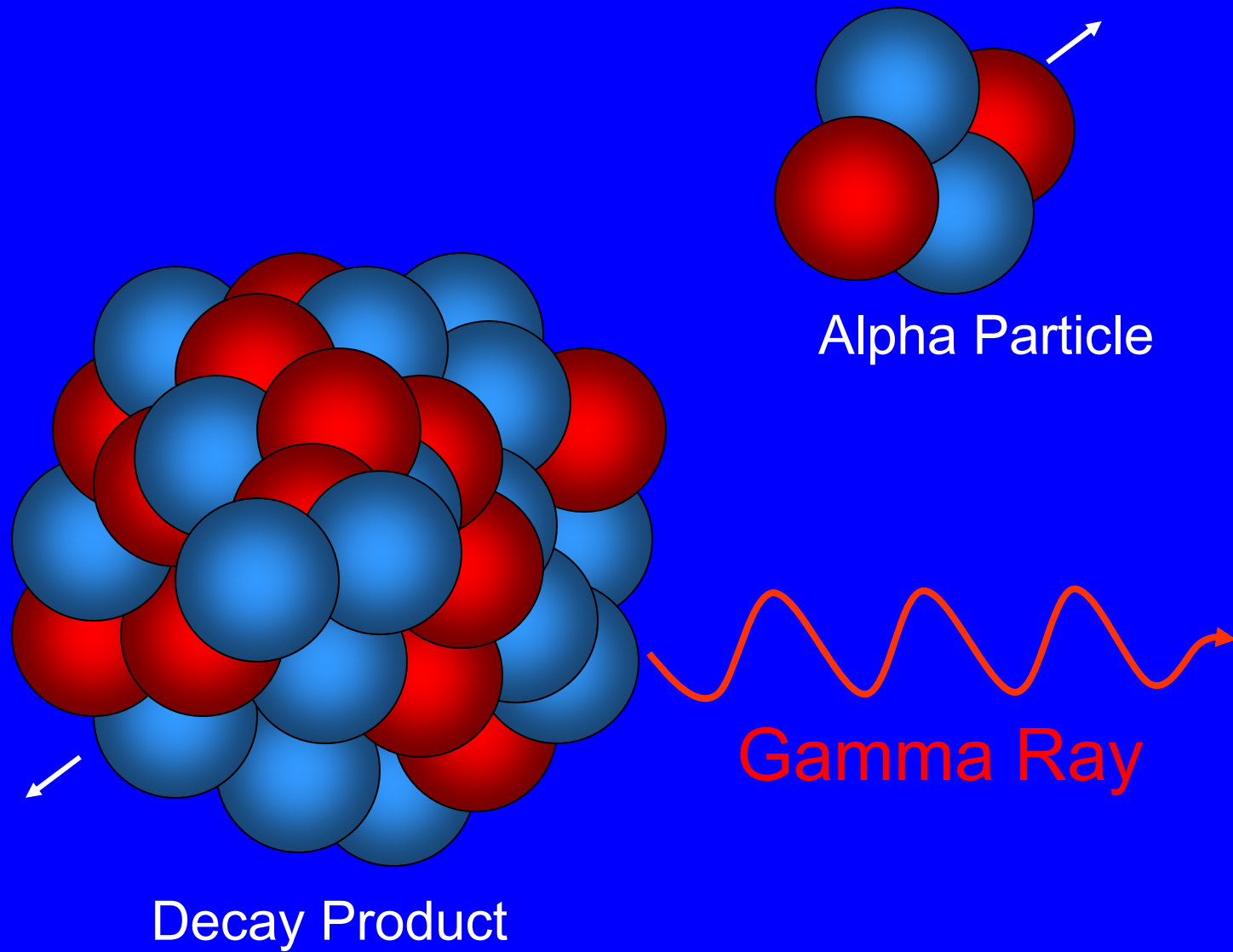

POSITRON DECAY AND ELECTRON CAPTURE

Positron Decay and Electron Capture

- Positron decay and electron capture are decay modes that are characteristic of nuclides above the line of stability - they have too many protons to be stable.
- In each case, a proton is converted into a neutron - the decay product is the same for both modes.
- Some nuclides only decay by positron emission, some nuclides only decay by electron capture, and some nuclides decay both ways (positron emission in a certain percentage of the decays and electron capture the rest of the time).

POSITRON DECAY

Positron Decay

- A positron is an antimatter electron “born” in the nucleus. It has the same mass as an electron but it has a positive charge.
- Positron emission is characteristic of nuclides above the line of stability - they have too many protons to be stable.
- In positron emission a proton is converted into a neutron (an up quark is converted into a down quark).
- A neutrino is also produced (ν).

Positron Decay

- In positron decay, a parent radionuclide decays into a decay product (daughter), a positron, and a neutrino:



- Positrons usually have more energy than beta particles - their positive charge causes them to be repelled by the positive charge of the nucleus in which they were born. In other words, they receive an extra “kick” when they leave the nucleus.

Positron Decay

- Every time a positron is produced, two 511 keV photons (annihilation radiation) will also be produced). These photons are rarely mentioned in decay data tables or other sources of information such as the chart of the nuclides.
- When the positron has given up all, or almost all, of its kinetic energy, it will combine with an electron – the electron and positron are attracted to each other because of their opposite charges.

Positron Decay

- The electron and positron annihilate each other - their mass is completely converted into electromagnetic energy.
- The annihilation of the electron produces a 511 keV photon and the annihilation of the positron produces a 511 keV photon. The two 511 keV photons head off in opposite directions (180 degrees apart).

Positron Decay

- It is common to depict positron decay as a decrease in energy as follows:

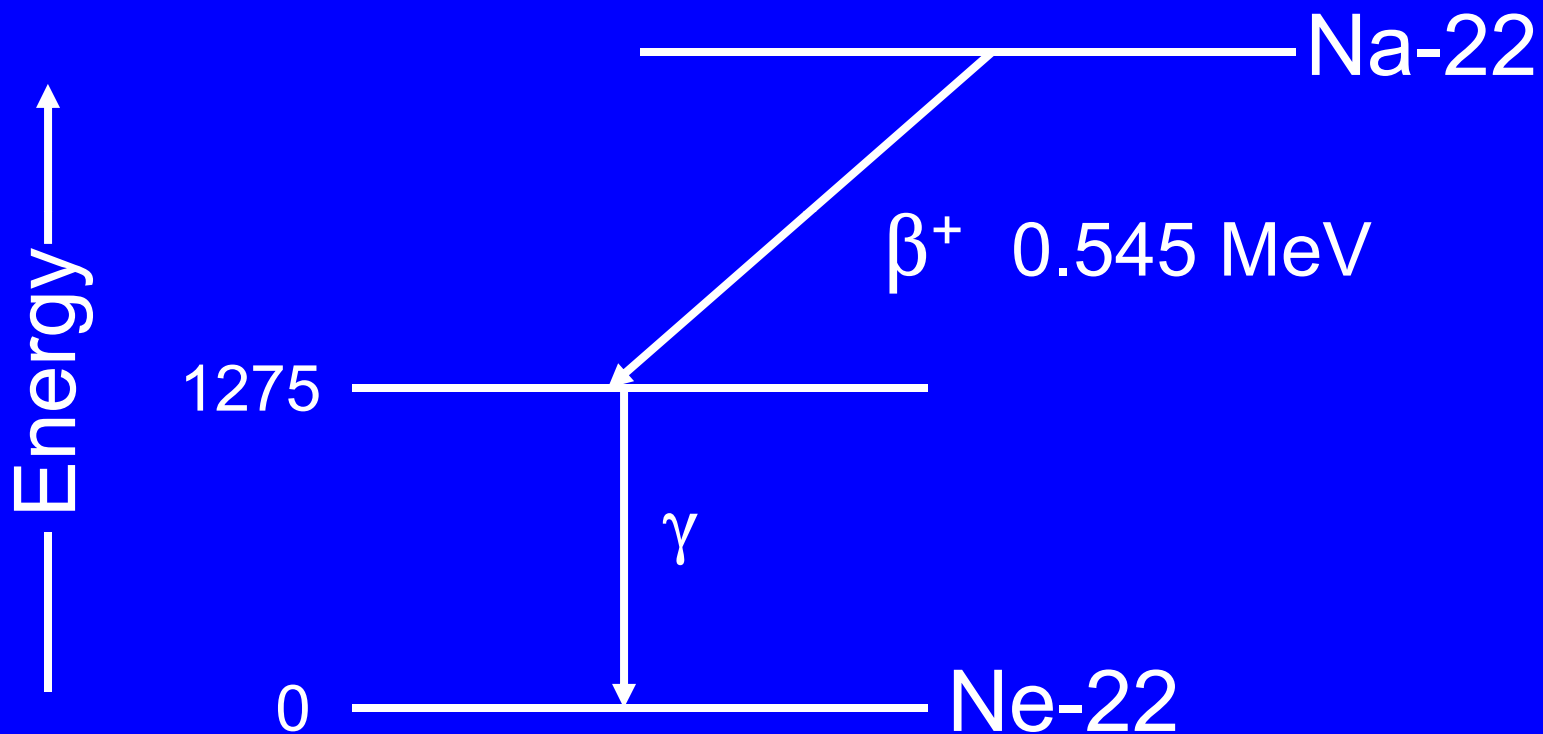

Positron Decay

- On the chart of the nuclides, positron decay results in moving diagonally one down to the right - a loss of one proton and a gain of one neutron.

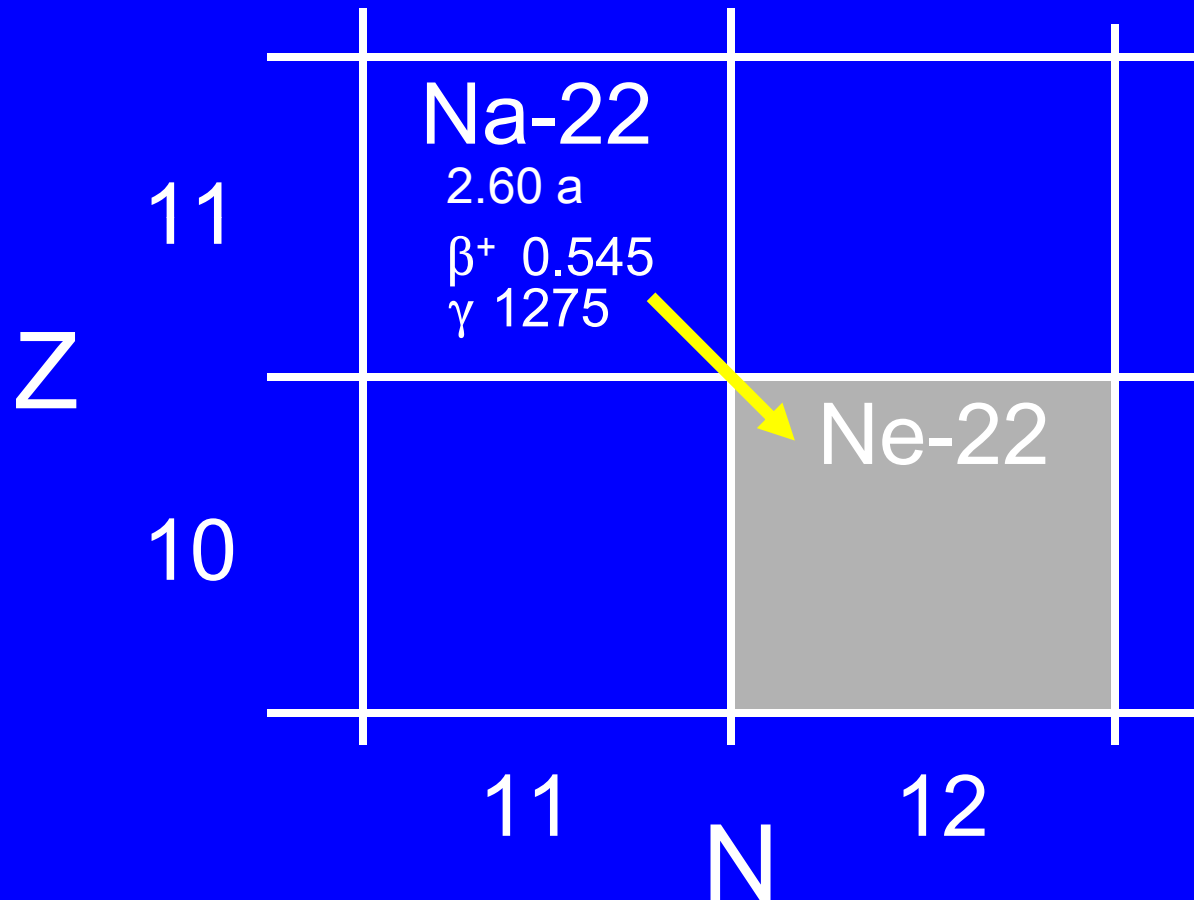

Positron Decay

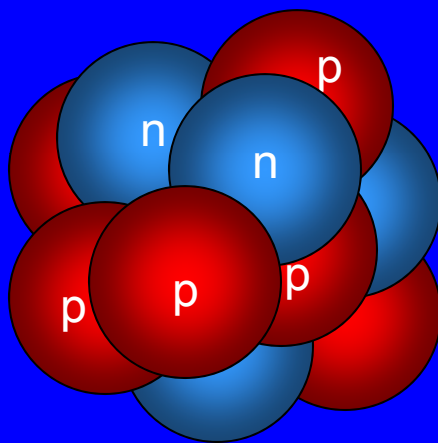

Parent Radionuclide

Positron Decay

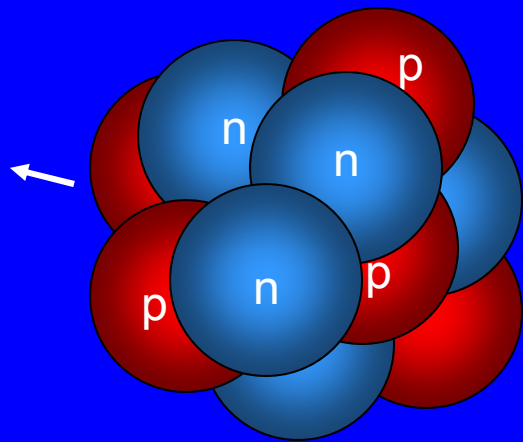

Decay Product

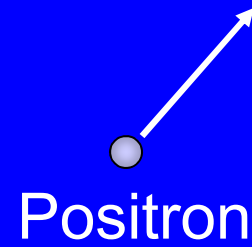

Neutrino

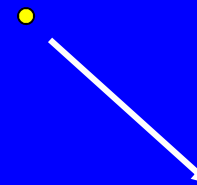

Positron Decay

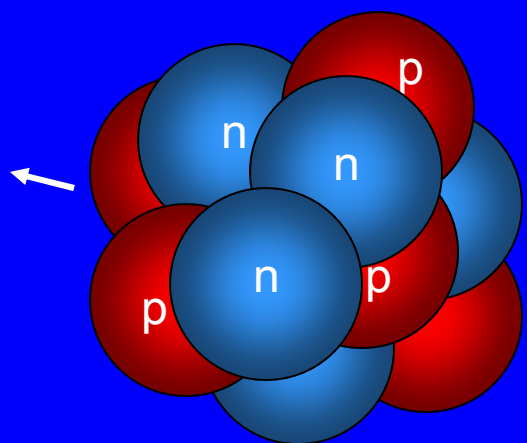

Decay Product

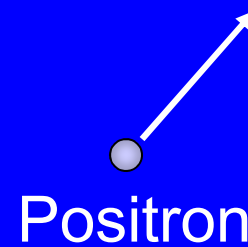

Positron

Neutrino

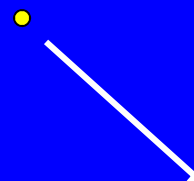

Positron Decay

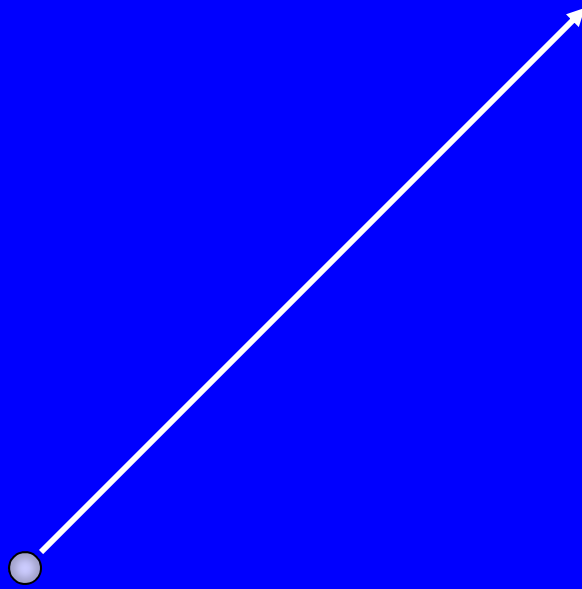

Positron (β^+)



Electron (e^-)
- an innocent bystander -

Positron Decay

Positron has given up all its kinetic energy.

Positron (β^+)



Electron (e^-)

- an innocent bystander -

Positron Decay

Because of their opposite charges, the positron and electron are attracted to each other.

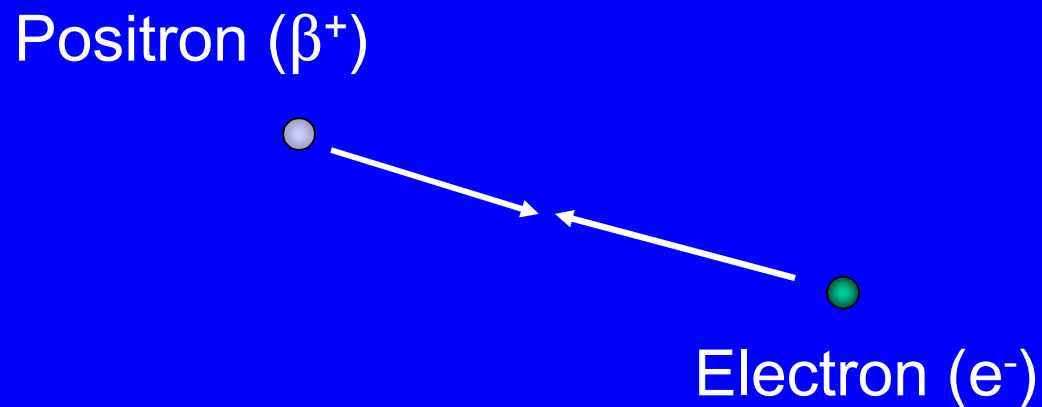

Positron Decay

Positron and electron annihilate each other.

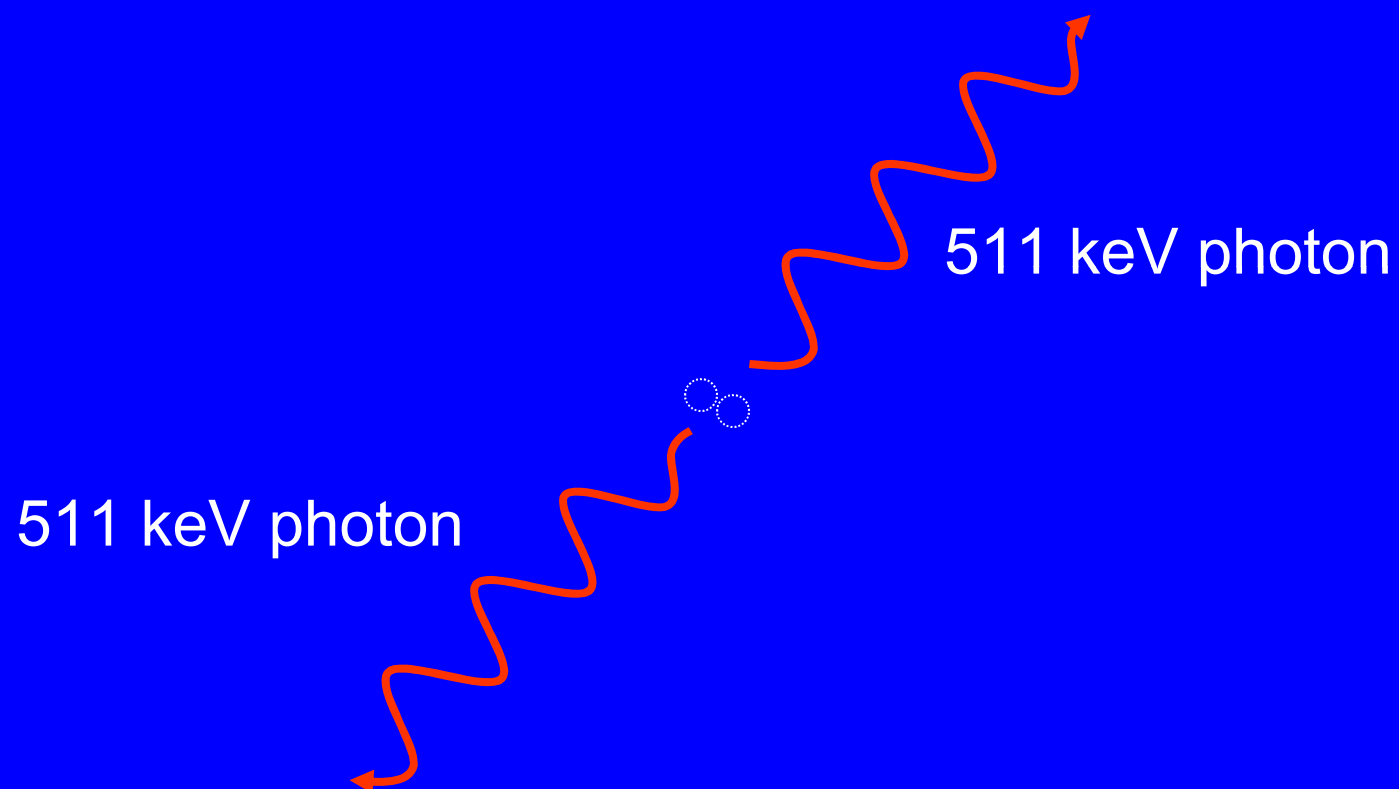

ELECTRON CAPTURE

Electron Capture

- In electron capture (EC or ϵ) the nucleus absorbs an orbiting electron.
- Electron capture is characteristic of nuclides above the line of stability - they have too many protons to be stable.
- In electron capture a proton is converted into a neutron (an up quark is converted into a down quark).
- A monoenergetic neutrino is also produced (ν).

Electron Capture

- The captured electron comes from one of the inner shells (e.g., K capture).



Example

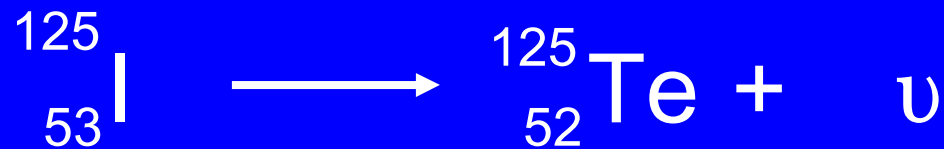

Electron Capture

- On the chart of the nuclides, electron capture results in moving diagonally one down to the right - a loss of one proton and a gain of one neutron.

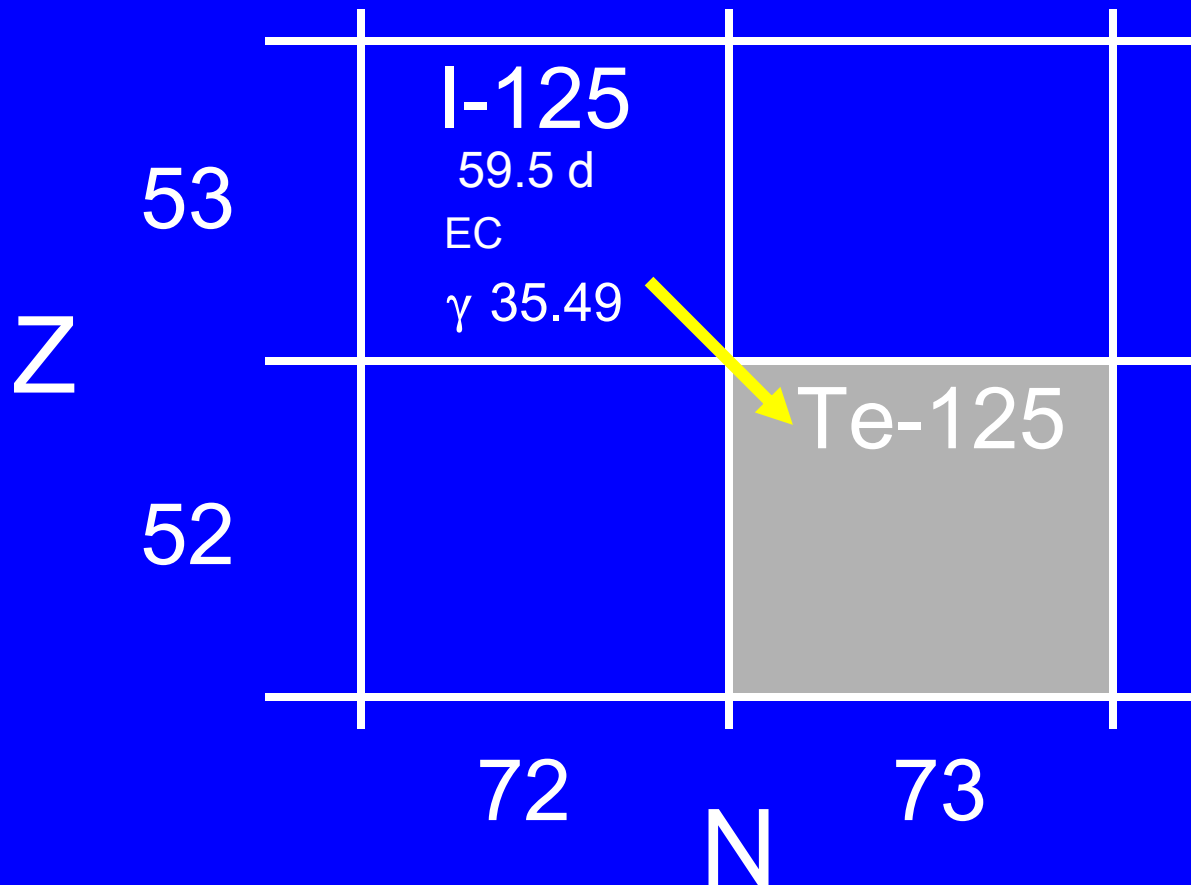

Electron Capture

- It is common to depict electron capture as a decrease in energy as follows (in this case, a gamma ray is also emitted):

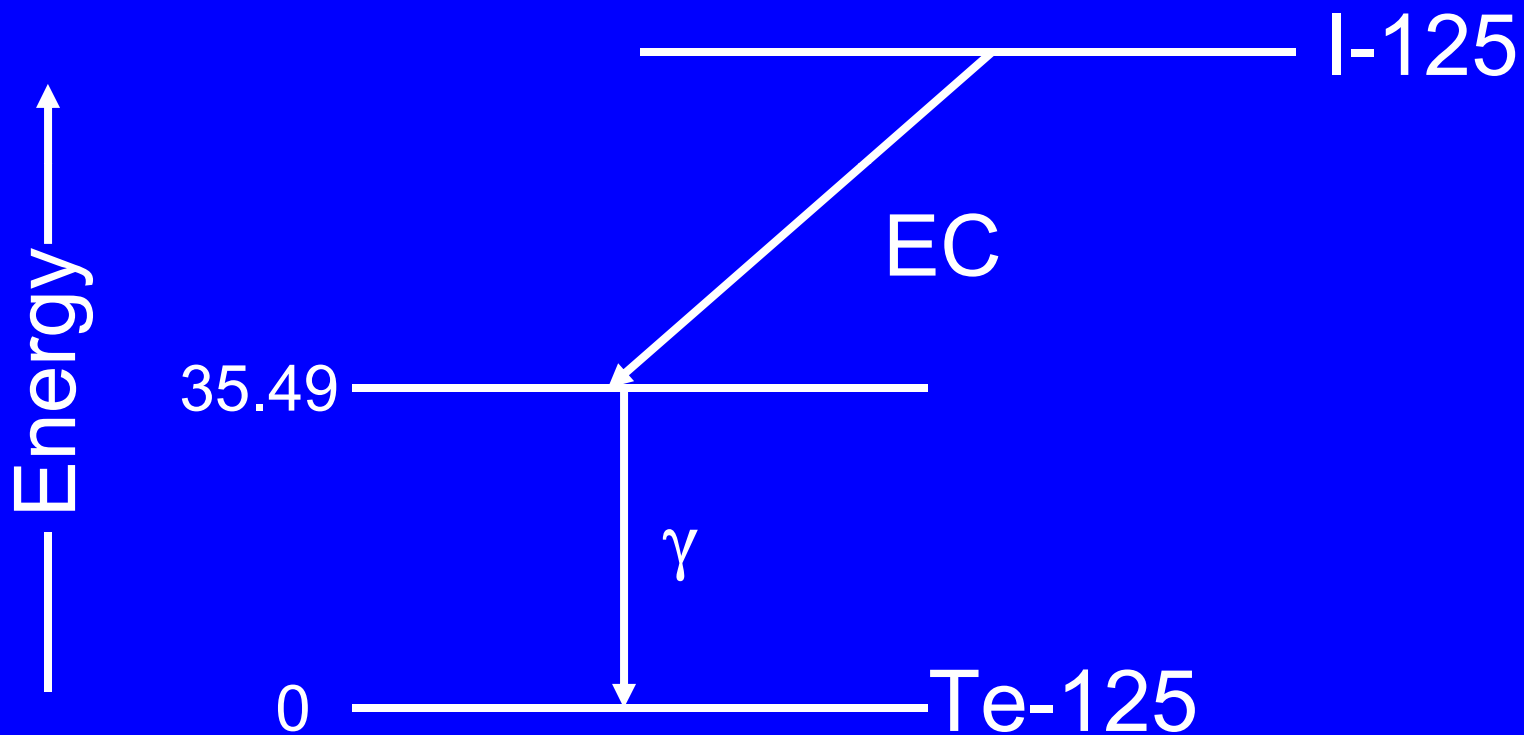

SPONTANEOUS FISSION

Spontaneous Fission

- A number of nuclides with large atomic mass numbers undergo spontaneous fission (sf). For example, many nuclides of plutonium can undergo spontaneous fission.
- Their primary mode of decay is usually alpha emission and they tend to have an even number of protons.
- Fission is a very effective method to rapidly change the number of neutrons and protons into a more stable combination.

Spontaneous Fission

- In fission, the parent radionuclide usually splits into two fission products.
- The split is not uniform. One of the fission products usually has an atomic mass number of 80 – 120 (e.g., Sr-90) while the other typically has an atomic mass number of 130 – 160 (e.g., Cs-137).
- The fission products have considerable kinetic energy.
- Several neutrons are also emitted (usually 2 – 4).
121

Spontaneous Fission

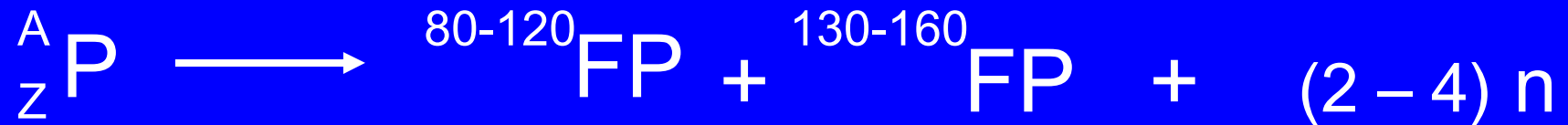

Example (one of many possible ways that Cf-252 can fission):

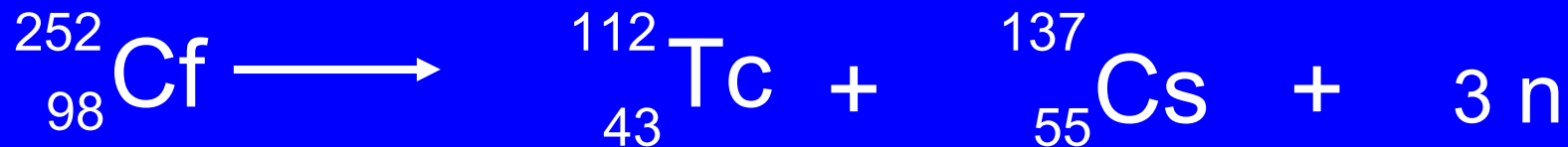

MULTIPLE MODES OF DECAY

Multiple Modes of Decay

- Some nuclides decay by more than one mode.
- For example, Cu-64 can undergo beta decay, electron capture or positron emission. Approximately 40% of the time, it undergoes beta decay, 40% of the time it undergoes electron capture and 20% of the time it undergoes positron emission.

Multiple Modes of Decay

- Potassium-40 can decay by one of two modes:

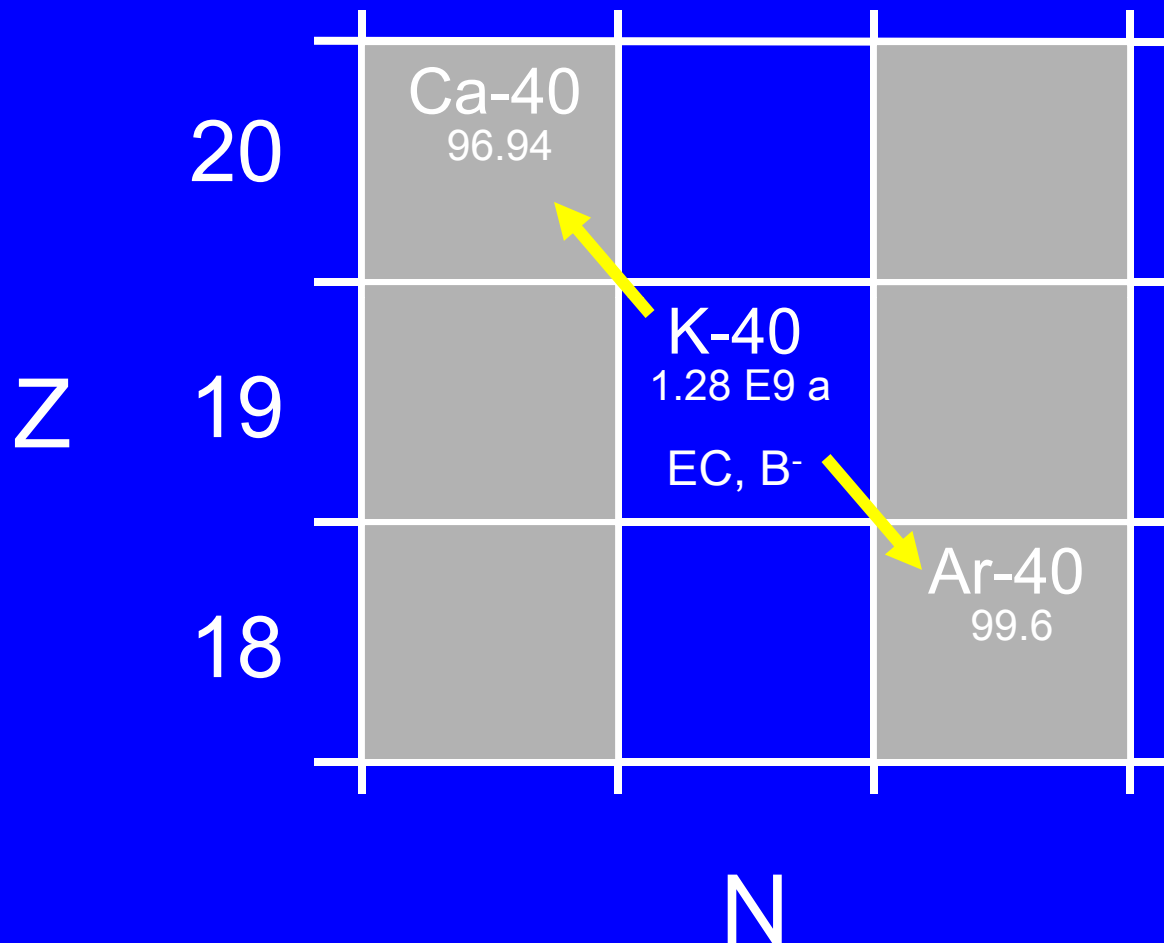

Multiple Modes of Decay

- It is common to depict decay as a decrease in energy as follows:

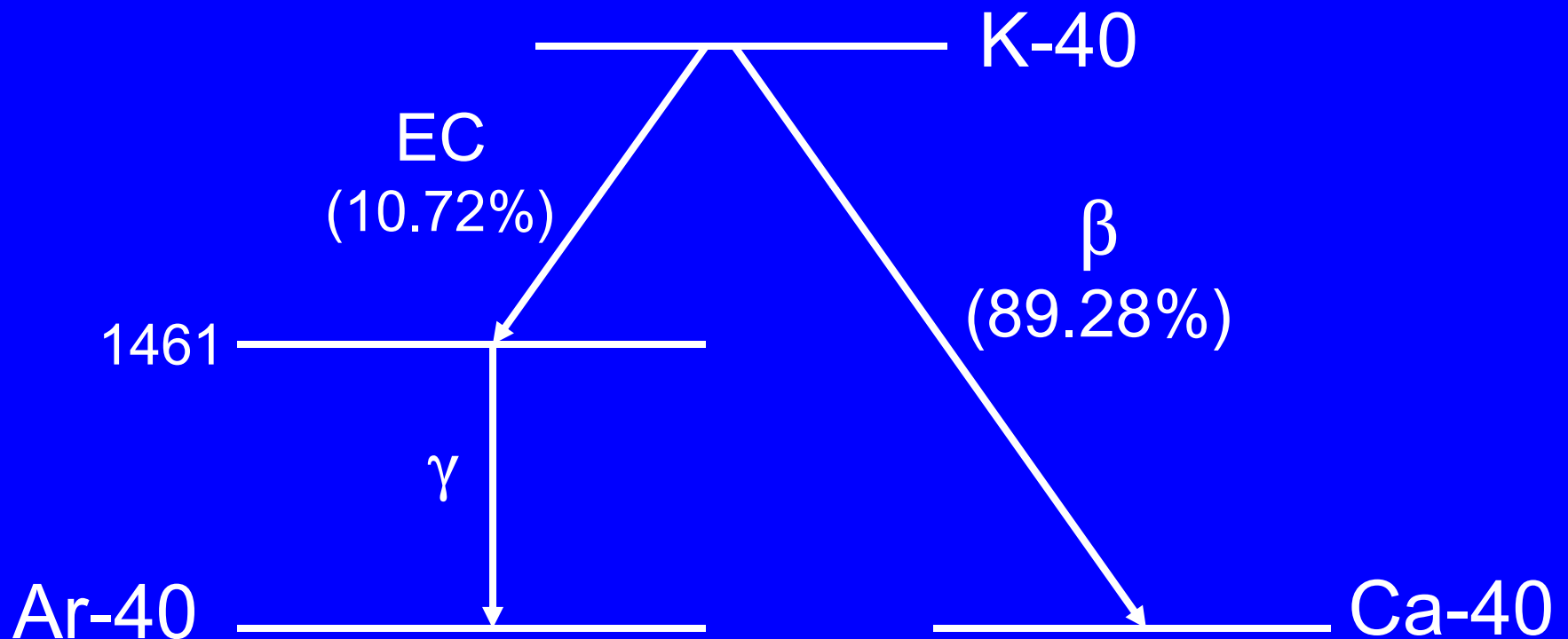

**CHART OF THE NUCLIDES
- ADDITIONAL INFORMATION -**

Chart of the Nuclides

σ indicates neutron cross sections in barns

Gray indicates stable nuclide

Percent abundance (by mass)

Half-life

P-32 emits beta particle with 1.709 MeV maximum energy

P-32 does not emit a gamma ray

<p>S32 95.02</p> <p>σ_γ .53, .26 $\sigma_\alpha \leq .5$ mb 31.9720707</p>	<p>S33 ^{3/+} 0.75</p> <p>σ_γ .45, .23 σ_α .14 σ_p 2 mb 32.9714585</p>
<p>P31 ^{1/+} 100</p> <p>σ_γ .17, .08 30.9737615</p>	<p>P32 ¹⁺ 14.28 d</p> <p>β^- 1.709 no γ E 1.7106</p>

Isotopic mass in amu

Chart of the Nuclides

Black box indicates naturally occurring radionuclide

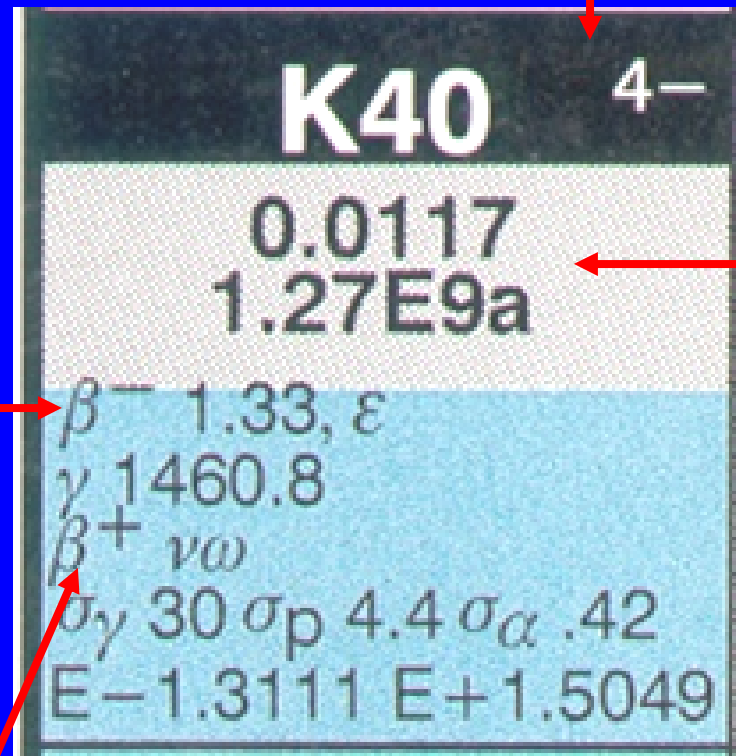

Two major decay modes: beta emission and electron capture

Grey box with both percent abundance and half-life indicates very long-lived radionuclide found in nature

Minor (very weak) decay mode: positron emission

Chart of the Nuclides

Black box indicates naturally occurring radionuclide - historical name is "Radium B"

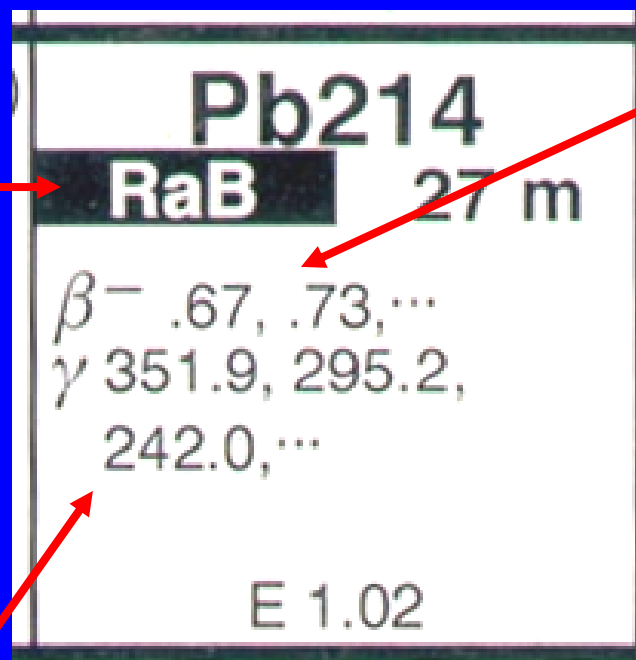

Indicates emission of two betas: one with maximum energy of 0.67 MeV and the other with a maximum energy of 0.730 MeV

Indicates that at least three gamma rays are emitted: 351.9 keV, 295.2 keV and 242.0 keV

Chart of the Nuclides

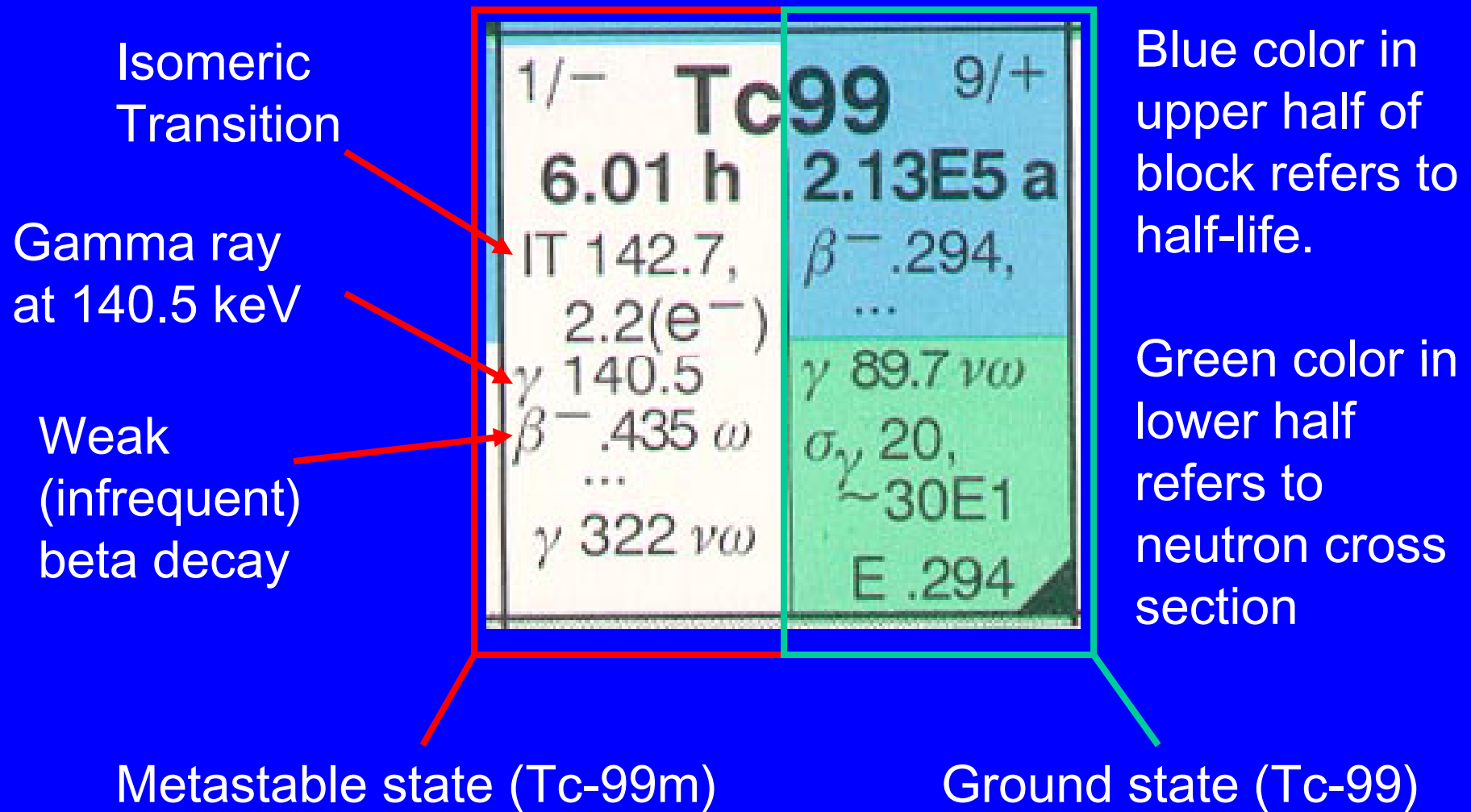

Q Values

Q Values

The Q value is the total energy change (usually in MeV) for a reaction or decay event.

It is the energy equivalence of the mass of the reactants (or parent radionuclide) minus that of the reaction products (or decay product).

A positive Q value indicates that the reaction is exothermic. All radioactive decay processes have a positive Q value.

A negative Q value indicates that the reaction is endothermic and that energy must come from one of the reactants (usually as kinetic energy).

Q Values

When mass is lost during radioactive decay, and if it is lost in a reaction, the energy released is the Q value.

It is calculated by Einstein's equation $E = mc^2$ which can also be expressed as:

$$Q \text{ (MeV)} = m \text{ (amu)} \times 931.5 \text{ (MeV/amu)}$$

Where m is the mass difference between the parent radionuclide (or reactants) and the decay products.

Q Values

In practice, Q is calculated in one of two ways;

1. Using the actual masses in amu
2. Using Δ (delta) values in MeV

Q Values – calculations using mass

Alpha Decay: $Q = 931.5 (M_p - M_d - M_\alpha)$

Beta Decay: $Q = 931.5 (M_p - M_d)$

Positron Decay: $Q = 931.5 (M_p - M_d - 2M_e)$

Electron Capture: $Q = 931.5 (M_p - M_d) - BE_e$

M_p is the atomic mass of the parent (amu)

M_d is the atomic mass of the decay product (amu)

M_e is the mass of an electron (0.000549 amu)

M_α is the mass of an alpha (4.0026 amu)

BE_e is the binding energy of the electron (MeV)

Q Values – calculations using Δ values

The delta value is the difference between a nuclide's atomic weight/mass (M) and its atomic mass number (A) expressed in MeV. The delta values for the different nuclides are looked up in tables.

$$\Delta = 931.5 (M - A)$$

The delta values provide a more convenient way to calculate the Q values than using actual masses.

Q Values – calculations using Δ values

Alpha Decay: $Q = \Delta_p - \Delta_d - \Delta_\alpha$

Beta Decay: $Q = \Delta_p - \Delta_d$

Positron Decay: $Q = \Delta_p - \Delta_d - 1.022$

Electron Capture: $Q = \Delta_p - \Delta_d - BE_e$

Δ_p is the delta value of the parent (MeV)

Δ_d is the delta value of the decay product (MeV)

Δ_α is the delta value of an alpha/He-4 (2.42 MeV)

BE_e is the binding energy of the electron (MeV)

The Q Value and Alpha Decay

When two particles of mass m and M (e.g., an alpha particle and the recoil nucleus of the decay product) share a given energy (Q), the kinetic energy of the two particles is:

$$\text{Energy of particle with mass } m = Q \left(\frac{M}{m + M} \right)$$

$$\text{Energy of particle with mass } M = Q \left(\frac{m}{m + M} \right)$$



Q Values – example using mass

When a boron-10 nucleus absorbs a thermal neutron, it becomes B-11 in an excited state. The excited B-11 nucleus can split to produce a Li-7 nucleus and an alpha particle.

In 4% of these reactions, the Li-7 is left in the ground state. As a result, the Li-7 and alpha particle share the maximum kinetic energy possible:



However, 96% of the time the Li-7 is left in an excited state. This leaves the Li-7 and alpha particle less kinetic energy to share.



Q Values – example using mass

The energy to be shared between the two particles is the Q value. It is the energy associated with the decrease in mass that occurs in the reaction and is calculated as follows:



Mass of neutron = 1.00866 amu

Mass of B-10 = 10.01294 amu

Mass of neutron and B-10 = 11.0216 amu

Mass of Li-7 = 7.01600 amu

Mass of alpha particle = 4.0026 amu

Mass of Li-7 and alpha = 11.0186 amu

Decrease in mass = 0.003 amu

Q value = 0.003 x 931.49 MeV/amu = + 2.79 MeV

Q Values – example using mass



The 4% of the time that the lithium is left in the ground state, the kinetic energies of the lithium and alpha particles are:

$$\text{Energy of Li-7} = Q \left(\frac{m}{m + M} \right) = 2.79 \text{MeV} \left(\frac{4.0026}{4.0026 + 7.016} \right) = 1.01 \text{MeV}$$

$$\text{Energy of alpha} = Q \left(\frac{M}{m + M} \right) = 2.79 \text{MeV} \left(\frac{7.016}{4.0026 + 7.016} \right) = 1.78 \text{MeV}$$

If the neutron that initiated the reaction had kinetic energy, that energy would have to be included in the Q value.

Q Values – example using Δ values

Positron Decay

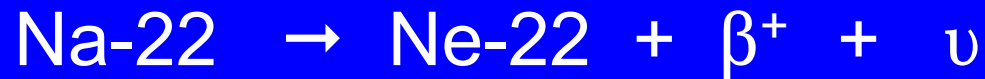

$$Q = \Delta_p - \Delta_d - 1.022$$

Δ_p is the delta value of the parent (MeV)

Δ_d is the delta value of the decay product (MeV)

$$\begin{aligned} Q &= \Delta_p - \Delta_d - 1.022 \\ &= -5.182 - (-8.025) - 1.022 \\ &= 1.821 \text{ MeV} \end{aligned}$$

Since the Q value is positive, this process is exothermic and can occur spontaneously.

Q Values – example using Δ values

When Na-22 undergoes positron decay, a 1275 keV gamma ray is emitted. As such it is impossible for all of the Q value energy to be given to the positron (or neutrino).

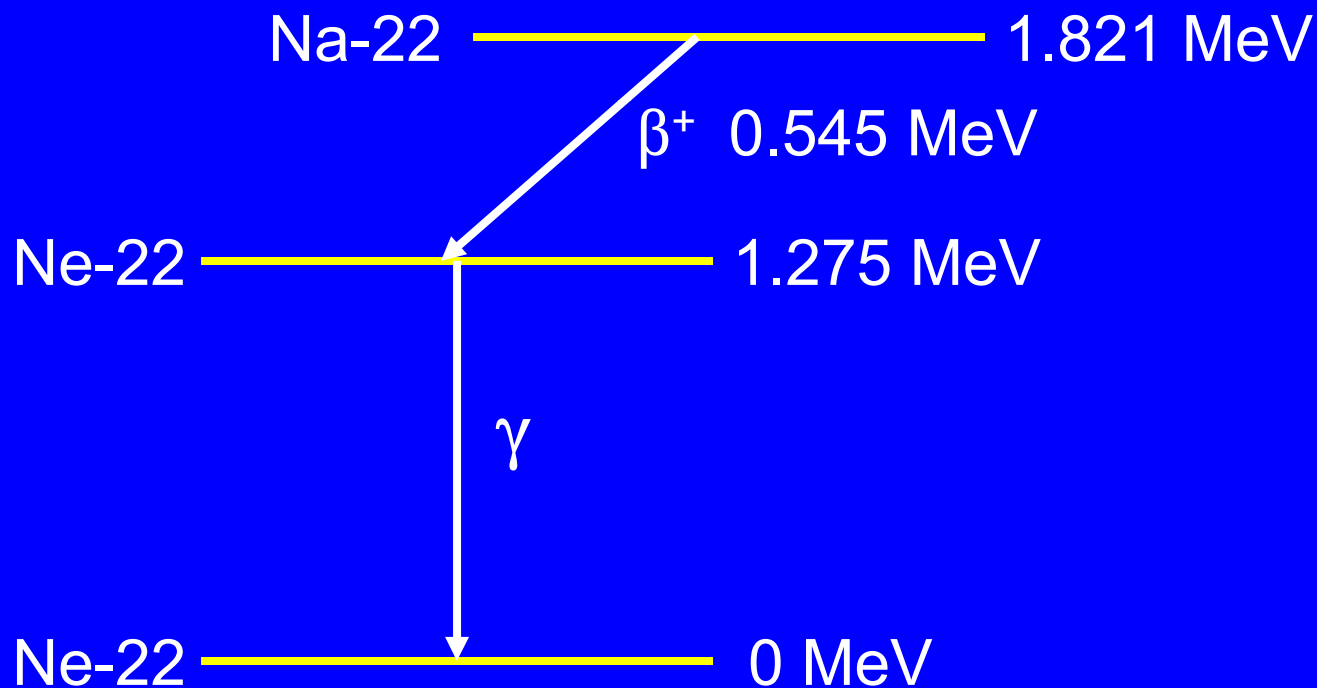

Effective Atomic Number

Effective Atomic Number

In some situations, the “effective atomic number” of a compound (e.g., H₂O) is of importance. The following equation has been widely employed to calculate the effective atomic number.

$$Z_{\text{Eff}} = \sqrt[2.94]{a_1 Z_1^{2.94} + a_2 Z_2^{2.94} + a_3 Z_4^{2.94} + \text{etc.}}$$

Z_{Eff} is the effective atomic number of the compound

A_n is the fraction of the total electrons in a material contributed by element n

Z_n is the atomic number of element n

Effective Atomic Number

Water, air and human tissue have effective atomic numbers on the order of 7.5 to 8.