

UNIVERSITY OF VIRGINIA

PAVILION IX



HISTORIC STRUCTURE REPORT

PAVILION IX
UNIVERSITY OF VIRGINIA

PAVILION IX

UNIVERSITY OF VIRGINIA

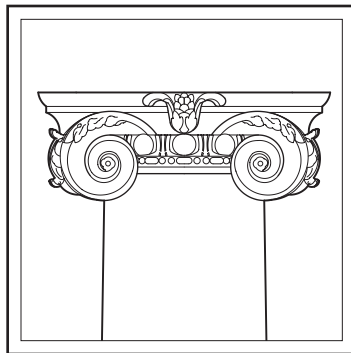

HISTORIC STRUCTURE REPORT

JOHN G. WAITE ASSOCIATES, ARCHITECTS PLLC
2010

© Copyright 2010
John G. Waite Associates, Architects PLLC and
The University of Virginia

*We would like to thank the following groups and individuals
for their assistance in the preparation of this report.*

University of Virginia

Teresa A. Sullivan, President
John T. Casteen, III, President Emeritus
Susan G. Harris, Secretary to the Board of Visitors
Colette Sheehy, Vice President for Management and Budget
Melissa F. Clarke, Director of Capital and Administrative Budgets
Robert J. Neil, Senior Budget Analyst

Office of the Architect for the University

David J. Neuman, Architect for the University
Brian E. Hogg, Senior Historic Preservation Planner
Mark S. Kutney, Conservator

University of Virginia Facilities Management

Donald E. Sundgren, Chief Facilities Officer
Joseph Dye Lahendro, Supervisory Historic Preservation Architect
James D. W. Zehmer, Historic Preservation Project Manager
Darrell Napier, Maintenance Supervisor,
and the staff of Cost Center Four

Prepared for
UNIVERSITY OF VIRGINIA

John G. Waite Associates, Architects PLLC

384 Broadway
Albany, New York 12207

Partner-in-Charge
John G. Waite, FAIA

Project Manager/Principal
Clay S. Palazzo, AIA

Principal
Douglas G. Bucher

Associates
Chelle M. Jenkins
Matthew K. Scheidt, AIA

Architectural Staff
Shannon E. Brown
Aaron Opalka
Edward A. Sehl

Architectural Historian
Mount Ida Press

Diana S. Waite
Maya E. Rook

CONTENTS

INTRODUCTION 9

THE JEFFERSONIAN PRECINCT 13

HISTORY 15

ARCHITECTURAL DESCRIPTION 69

PROBLEMS OF REPAIR 163

RECOMMENDATIONS 191

INTRODUCTION

After Thomas Jefferson completed his second term as President of the United States in 1809, his principal effort, until his death in 1826, was the creation and construction of what became The University of Virginia. The new University was designed by Jefferson with the consultation of Benjamin Henry Latrobe, the first professionally trained architect in America, who was also Jefferson's Surveyor of Public Buildings (the position later developed into the Architect of the Capitol). The construction of the buildings designed by Jefferson began with Pavilion VII in 1817 and ended with the completion of the Rotunda in 1828.

Of all the original Jefferson buildings constructed at the University, Pavilion IX and the Rotunda are the ones where Jefferson had the greatest collaboration with Latrobe. The Pavilion IX Historic Structure Report, as well as others recently completed by John G. Waite Associates, Architects for the Rotunda and Latrobe's Baltimore Cathedral, further illustrates the close working relationship between Jefferson and Latrobe and the high degree of professional respect that each had for the other. Not only were architectural design issues frequently discussed, but the two shared a deep interest in building technology and construction methods. This collaboration resulted in a pavilion whose front elevation is unique among the pavilions: starkly simple, balancing the geometry of the large, central arched recess and the flanking windows. Its design has long been a favorite among architects.

This report is the latest in the series of historic structure reports for the buildings of Thomas Jefferson's Academical Village, which began with the preparation of the first report dealing with Pavilion I in 1991. The Pavilion IX report, like the previous studies, strongly advocates the adoption of a sound curatorial approach to the maintenance, renewal and restoration of the Jefferson buildings at the University. Just as an art conservator would not intervene in the life of a significant artifact before obtaining a thorough knowledge of its history, composition and significance, so those engaged in the preservation of buildings should proceed only from a basis of knowledge. Far too often in the past, the cultural integrity of buildings and their settings have been compromised by approaches to restora-

PAVILION IX

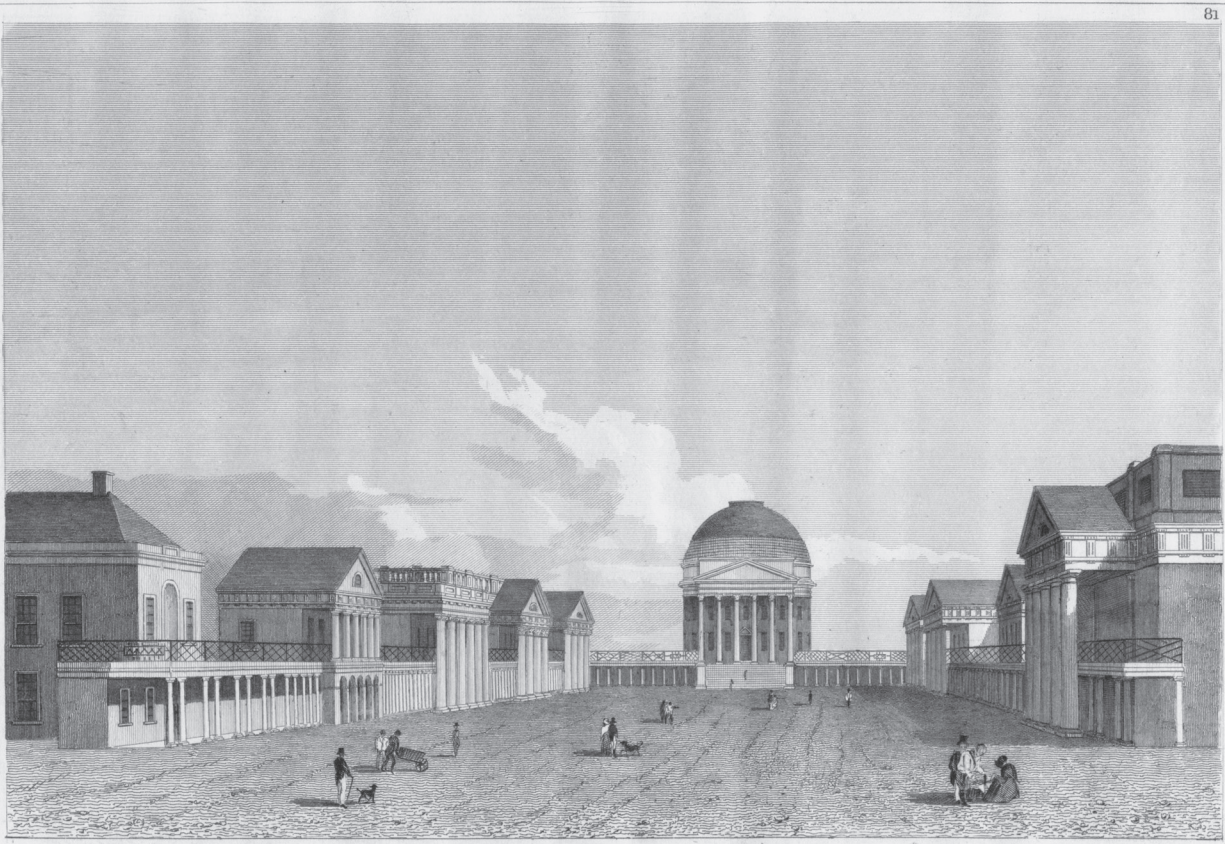

Drawn by W. Goodacre N.Y.

Engraved & Printed by
Fenner Sears & Co.

UNIVERSITY OF VIRGINIA, CHARLOTTESVILLE.

*University of Virginia from the south, drawn by William Goodacre
and engraved and printed by Fenner Sears and Co., 1831*

INTRODUCTION

tion that have been grounded in personal whim, willful romanticism, and expedient ideas of repair and renewal.

The preparation of a historic structure report is the first step in developing a disciplined approach to the care of a historic building. Over the past year, a team of architects, architectural historians and building conservators has carried out the recording and investigation of the building. There has been a review of the archival information regarding Pavilion IX and a thorough examination of its building fabric. All elements of the building have been examined to determine date of origin, existing condition and scope of needed repairs. A permanent graphic and written record of these findings has been prepared. Assembling the minutiae of the building's history and current conditions creates a benchmark that will not only provide a guide for immediate work, but will furnish future generations with a clear picture of what was found in our time.

Gleaning from Thomas Jefferson's papers, the University's archives and other written accounts and graphic materials, it has been possible to assemble a history of the building's design, construction, subsequent alterations and use. Careful measurement of all exterior and interior features has made possible the preparation of a set of architectural drawings which illustrate the present configuration, as well as the evidence of its historical conditions.

The investigations uncovered evidence of the original parapet on the roof of the building, fragments of early wallpaper in the basement kitchen closet, and evidence of a dumbwaiter in the 1831 addition. These features provide valuable information on the early construction history of the University.

The core team that prepared this report (Clay S. Palazzo, Douglas G. Bucher, Chelle M. Jenkins and John G. Waite, as well as Mt. Ida Press) has been the principal team for the preparation of all the UVA historic structure reports prepared by John G. Waite Associates and its predecessor firm Mesick, Cohen, Waite Architects, dating back to 1988. Their work includes historic structure reports for Pavilion I, Pavilion II, Pavilion V, Pavilion VI and the Rotunda. The same team prepared historic structure reports for other UVA buildings not designed by Thomas Jefferson, including Varsity Hall, Rouss Hall and Cocke Hall.

PAVILION IX

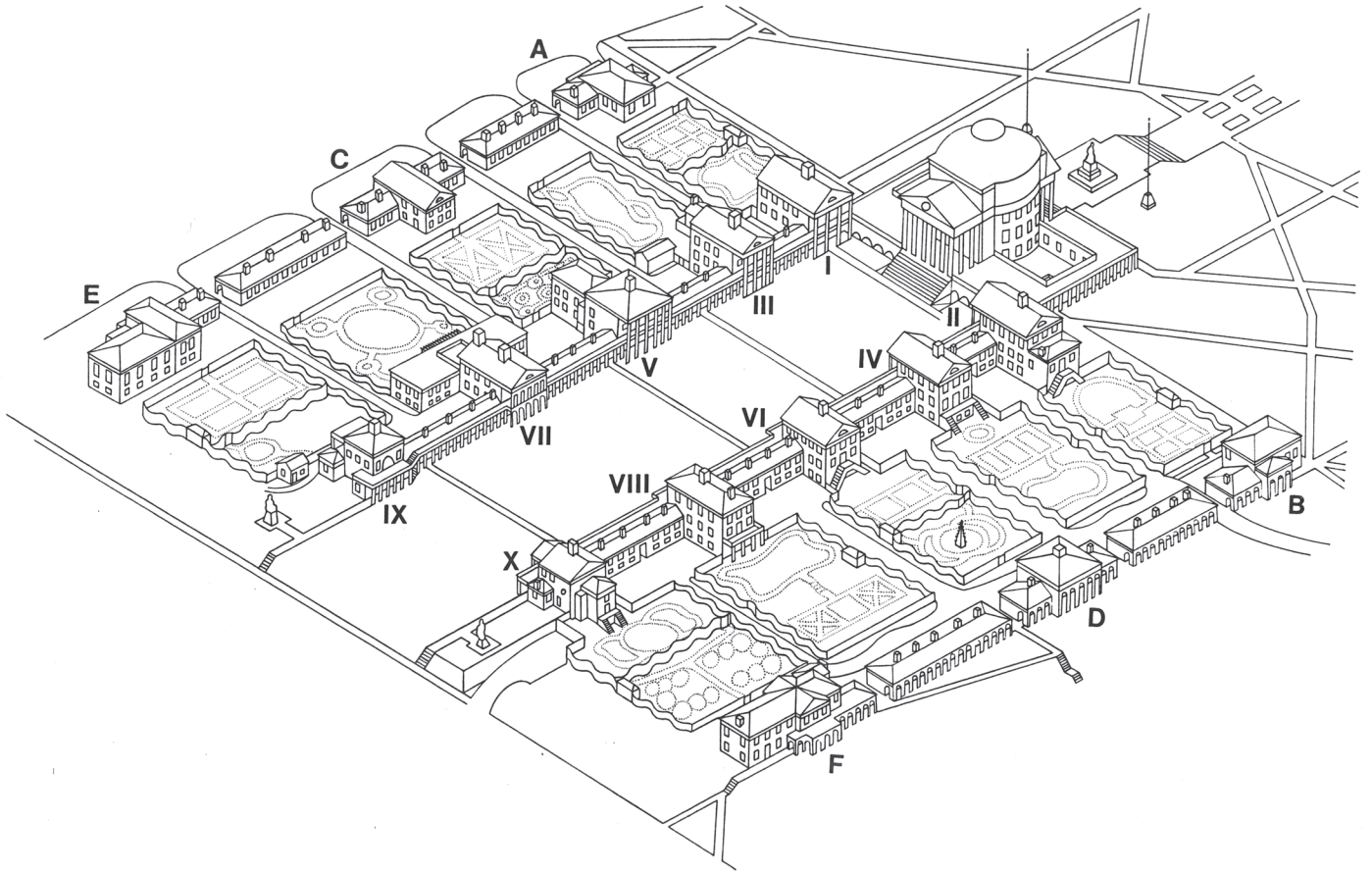

The Jeffersonian Precinct

PAVILION IX

THE JEFFERSONIAN PRECINCT

Originally called the Academical Village, the present Jeffersonian Precinct of the University of Virginia occupies a twenty-eight-acre site in the rolling hills just east of the Shenandoah Valley. The original U-shaped complex of buildings is situated on an elevated site that slopes gently down toward the south. The Rotunda, which originally housed classrooms and the library, is located at the heart of the complex at the northern end of the central green space, called the Lawn. Two rows of five pavilions, each with connecting dormitory rooms, form the east and west sides of the Lawn and terminate at the foot of the Rotunda. Behind each row of pavilions is a row of three hotels, which were built as eating facilities, and connecting dormitory rooms. Between these inner and outer ranges are gardens bounded by serpentine walls.

The ten pavilions are numbered I to X. Odd-numbered pavilions are on the west, and even numbered pavilions are on the east. The lower the number of the pavilion, the closer it is to the Rotunda. Each of the pavilions originally housed one of the University's ten original, separate schools. Each contained classrooms and the professor's living quarters. The professors lived on the upper floors and taught their classes on the lower floors.

The pavilions are connected by a continuous colonnade, which offers shelter from the weather and partially screens the utilitarian dormitories from public view. The walkway on the roofs of the colonnade that connects the second-floor levels of the pavilions is reserved for the private use of the faculty and their families.

Each of the pavilions was designed by Thomas Jefferson with elements drawn from classical models as published by Palladio, Fréart de Chambray, and Charles Errard. Each is different, thereby offering a separate lesson in classical orders and architecture.

The Lawn itself measures 740 feet in length and 192 feet in width. Lined with rows of trees, the Lawn is terraced in gradual steps from north to south. The Jeffersonian Precinct is separated from the newer sections of the University by roads on the west, north, and east sides and by a wide walkway on the south.

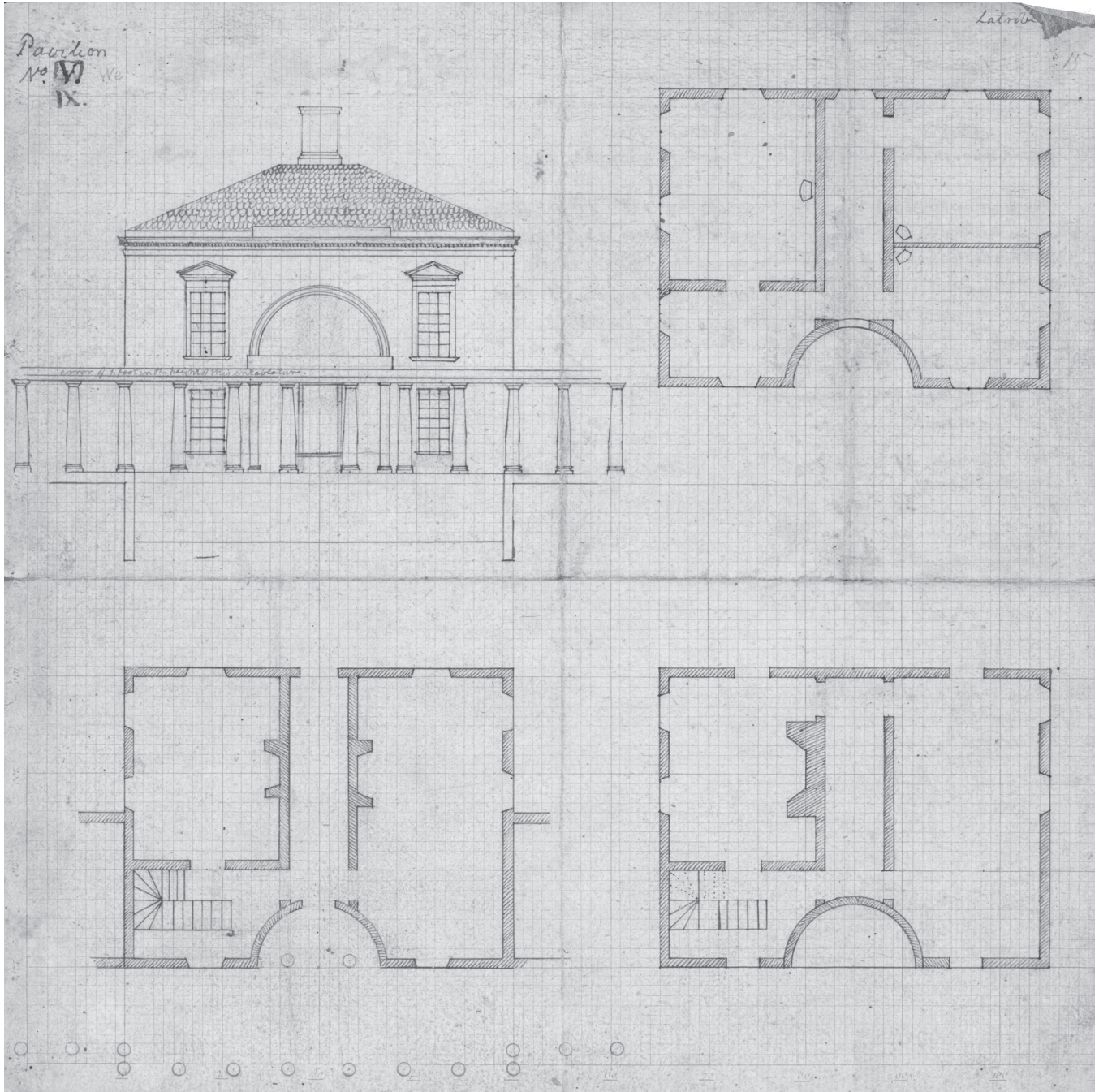

Thomas Jefferson's 1819 elevation and plans for Pavilion IX

PAVILION IX

HISTORY

JEFFERSON'S PLAN FOR THE UNIVERSITY AND THE PAVILIONS

Thomas Jefferson's concepts—both educational and architectural—about a public university for Virginia date to at least 1779, when as governor, he had proposed a public educational system that would begin with primary schools and extend up through a university. A quarter century later, as the Virginia General Assembly debated the feasibility of such an institution, Jefferson set forth his ideas not only about its purpose, location, funding, and faculty but also about its architectural design and construction. In 1805, as delegates to the General Assembly were drafting a bill to create a university, Jefferson wrote that “the greatest danger will be their over-building themselves by attempting a large house in the beginning, sufficient to contain the whole institution.” “Large houses are always ugly; inconvenient, exposed to the accident of fire, and bad in cases of infection,” he continued. “A plain small house for the school & lodging of each professor is best. These connected by covered ways out of which the rooms of the students should open would be best. These may then be built only as they shall be wanting. In fact an University should not be an house but a village. This will much lessen their first expences.”¹

Over the next five years Jefferson remained convinced of the benefits of his plan, and in 1810 he advised the trustees of a new college in Tennessee that rather than having “one large & expensive building,” it would be “infinitely better to erect a small and separate lodge for each separate professorship, with only a hall below for his class, and two chambers above for himself; joining these lodges by barracks for a certain portion of the students opening into a covered way to give a dry communication between all the schools, the whole of these arranged around an open square of grass & trees would make it, that it should be in fact, an academical village, instead of a large & common den of noise, of filth, & of fetid air.” Such a plan, he proposed, “would afford that quiet retirement so friendly to study, and lessen the dangers of fire, infection & tumult.” “Every professor,” Jefferson continued, “would be the

PAVILION IX

police officer of the students adjacent to his own lodge, which should include those of his own class of preference, and might be at the head of their table if, as I propose, it can be reconciled with the necessary economy to dine them in smaller and separate parties rather than in a large & common mess. These separate buildings too might be erected successively & occasionally, as the number of professorships & students should be increased or the funds become competent.”² In 1814 Jefferson prepared a site plan illustrating his “academical village” concept for the Albemarle Academy, a school proposed but never built, along with an elevation and plan for a typical pavilion and flanking dormitories.³

In February 1816 the Virginia General Assembly passed a bill establishing Central College, to be located in Albemarle County. A meeting of the Board of Visitors, the governing body of the new college, was scheduled for early April 1817, but the board was unable to take official action since there were only three members in attendance. Under Jefferson’s leadership, the participating Visitors, however, did make site visits to various locations proposed for the university and “provisionally authorized” the purchase of land “about a mile above the town.”⁴

On April 13 Jefferson, apparently confident that his architectural scheme for the college would eventually be adopted and that construction would begin soon, wrote to James Dinsmore, a master craftsman who with John Neilson had worked with Jefferson at Monticello, to interest them in the Charlottesville project. Jefferson explained that “we do not propose to erect a single grand building, but to form a square of perhaps 200 yards, and to arrange around that pavilions of about 24. by 36. f. one for every professorship & his school. they are to be of various forms, models of chaste architecture, as examples for the school of architecture to be formed on.” “We shall build one [pavilion] only in the latter end of this year,” he continued, “and go on with others year after year, as our funds increase.” He anticipated that the “superintendance of the buildings will rest chiefly on myself as most convenient. so far as it does I should wish to commit it to yourself and mr Nelson.” Jefferson noted that there would be little construction “called for this year which might disturb your present engagements,” but “it will open a great field of future employment for you.” “Will you undertake it?” he asked Dinsmore. If so, he asked that they let him know before May 6, the day after the next meeting of the Board of Visitors.⁵ Dinsmore accepted, writing Jefferson from Petersburg, Virginia, on April 22 that “the proposition you make is most agreeable to me and I with pleasure accept it.”⁶

The Board of Visitors of Central College met again on May 5, 1817. With a quorum in place, they authorized the purchase of the property that had been agreed upon in April, some 44 acres just west of Charlottesville, and they also adopted Jefferson’s master plan for the college. The Visitors viewed a drawing of “a plan presented to the trustees of the

HISTORY

Albemarle academy,” probably the one that Jefferson had prepared in 1814. According to the minutes of the meeting, this plan provided for “erecting a distinct Pavilion or building for each separate professorship, and for arranging these around a square, each pavilion containing a schoolroom & two apartments for the accommodation of the Professor with other reasonable conveniences.”⁷ This drawing showed three pavilions connected by dormitories along both the east and west sides of the Lawn and three more equally sized pavilions, also flanked by dormitories, across the north end.

At the same May meeting the Visitors also agreed that “one of those pavilions shall now be erected,” and they directed the proctor “so soon as the funds are at his command to agree with proper workmen for the building of one, of stone or brick below ground, & of brick above, of substantial work, of regular architecture, well executed, and to be completed if possible during the ensuing summer & winter.” The Visitors were also concerned with the positioning of this first building and the grading of the site: they directed that the pavilion be constructed so that its floor would be “in such degree of elevation from the ground as may correspond with the regular inclined plane to which it may admit of being reduced hereafter.” The proctor was also authorized, funds permitting, to build up to ten dormitories adjoining each side of the pavilion; the dormitories were to be constructed “of brick, & of regular architecture according to the same plan proposed.”⁸ This first pavilion would be known as Pavilion VII, and eventually Pavilion IX would be its neighbor to the south.

SOLICITING ARCHITECTURAL EXPERTISE FOR THE PAVILIONS

Meanwhile, just four days after the May meeting of the Board of Visitors, Jefferson wrote to William Thornton, the first architect of the U.S. Capitol, soliciting his advice about the design for the college. Jefferson first explained his overall concept and some details about the pavilions:

We are commencing here the establishment of a college, and instead of building a magnificent house which would exhaust all of our funds, we propose to lay off a square of about 7. or 800. feet on the outside of which we shall arrange separate pavilions, one for each professor and his scholars. each pavilion will have a schoolroom below, and 2 rooms for the Professor above and between pavilion and pavilion a range of dormitories for the boys, one story high, giving to each a room 10. f. wide & 14. f. deep. the pavilions about 36. wide in front and 24. f. in depth.

the whole of the pavilions and dormitories to be united by a colonnade in front of the height of the lower story of the pavilions, under which they may go dry from school to school. the colonnade will be of square brick pilasters (at first) with a Tuscan entablature.

PAVILION IX

“Now what we wish is that these pavilions as they will show themselves above the dormitories, should be models of taste & good architecture, & of a variety of appearance, no two alike, so as to serve as specimens for the Architectural Lectures,” Jefferson continued. He then asked Thornton, “will you set your imagination to work & sketch some designs for us, no matter how loosely with the pen without the trouble of referring to scale or rule; for we want nothing but the outline of the architecture, as the internal must be arranged according to local convenience. a few sketches, such as need not take you a moment, will greatly oblige us.” The Visitors, Jefferson explained, have “to struggle against two important wants, money, and men for professors capable of fulfilling our views.” Jefferson saw the physical plant of the university as an asset for recruiting the faculty, and he wanted Thornton to “help us provide snug and handsome Lodges for them.”⁹

Thornton soon replied, pointing out practical as well as aesthetic considerations. First, he wrote, it was “necessary to consider the extent of the learning intended to be inculcated by this Institution.” If it were to be a university, then having only two rooms on the upper floors of the pavilions would likely prove inadequate for “the masters, or Professors of the Sciences, & the high grades of learning”; “Great & learned men,” he wrote, “would necessarily be considered as Gentlemen of high Character & Consideration, & would expect to be provided for accordingly,” especially those needing more space for their families. Additionally, if university-level courses were being offered, then the professors would also need “Accommodations for the Apparatus, chymical, philosophical, Mechanical &c.” He noted that the first-floor “Halls would require to be large, if intended for lecturing.” If so, then the greater height of the first story would mean that the upper stories “would be in better proportion as to height.”¹⁰

As part of his comments on Jefferson’s overall plan, Thornton inserted a revised partial site plan in the body of his letter, drawing “a Pavilion for the Centre, with Corinthian Columns & a Pediment” and creating pavilions with L-shaped plans at the north corners; in Thornton’s scheme, the central structure would be the only building with a pediment. Thornton was lukewarm about Jefferson’s idea of having the pavilions serve as models of the various orders of architecture: “I would advise only the *three* orders,” he wrote, “for I consider the Composite as only a mixture of the Corinthian & Ionic; & the Tuscan as only a very clumsy Doric.” Rather than having square pillars in the colonnades in front of the dormitory rooms, Thornton recommended using columns, for they “are not only handsomer but cheaper, being also more easily built, and less subject to accidental as well as willful injury.” He advised against using plinths under the columns, since “they not only tend to shorten the Columns but increase the expense, interrupt the walk, and add not much to the beauty.” The columns, he assured Jefferson, could very successfully “be built of Brick in

HISTORY

the roughest manner, & plastered over in imitation of freestone.” Thornton also sent Jefferson two drawings of facades of the pavilions, both standing above an arcade at the ground level.¹¹

In mid-June, needing more expert advice, Jefferson wrote to architect Benjamin Henry Latrobe, the former surveyor of public buildings whom Jefferson had known when he was president of the United States. Using much of the same language as in his letter to Thornton, Jefferson outlined the overall scheme for the college and asked Latrobe to “take up your pencil, and sketch for us some general outlines of designs no matter how loose, or rough, without the trouble of referring to scale or rule; for we want nothing but the general idea of the external...a few sketches such as shall take you not more than a minute apiece, mere impressions of a first trait of imagination, will greatly oblige us.”¹²

Latrobe took an immediate interest in Jefferson’s project, writing on June 28, 1817, that he had “found so much pleasure in studying the plan of your College, that the drawings have grown into a large bulk than can be conveniently sent by the Mail.” He hoped to enlist acquaintances to convey his drawings to Jefferson via Richmond, but a month later he still had not sent them.¹³ Latrobe did, however, incorporate many of his design elements into a sketch that he included in a July 24 letter to Jefferson. In this sketch Latrobe created a monumental structure at the center of the north side of the lawn, which would evolve into the design for the Rotunda. Its façade projected well beyond the flanking colonnades, as did the facades of the pavilions. Latrobe also showed the footprints of the pavilions as being much squarer than those shown in Jefferson’s and Thornton’s drawings, where the pavilions had been rectangular in plan, with the longer side being parallel to the colonnades.¹⁴

In a letter to Latrobe written a few days later, in early August 1817, Jefferson sketched an elevation and plan showing how the terraces between the two rows of pavilions and dormitories would step down from north to south; this drawing also showed the pavilions as having pediments.¹⁵ He told Latrobe that the first pavilion would be completed in 1817 and that the one to the north (Pavilion V) and the one to the south (Pavilion IX) would be built “the next [year] with their dormitories, so that there will be a continued line of building” along the west side of the lawn. The north side would remain open, in case “the state should establish there the University they contemplate, they may fill it up with something of the grand kind.” Jefferson told Latrobe that “What we now want is a variety of sketches for the fronts of the pavilions; out of which we chuse the handsomest.” Jefferson also mentioned leaving the “back sides of our pavilions without windows,” so that extensions could be added.¹⁶

In mid-August Latrobe wrote Jefferson that he had “suspended my drawing. It contained a plan of the principal range of building (as I then supposed it) and seven or eight Elevations of pavilions, with a general Elevation of the long range of Pavilions & portico.

PAVILION IX

In this State I will send it to you. If there is any thing in it which you think usefull, it is yours." Latrobe also lectured Jefferson on what he considered the very unfortunate "aspect" of the pavilions, as well as the dormitories, which faced east and west, rather than taking advantage of the climatically more desirable southern orientation.¹⁷

In his reply Jefferson stated that we would be "glad to receive your drawings...the elevations of pavilions will be most acceptable," and he enclosed "a very ragged sketch of the one now in hand," Pavilion VII. He also defended the orientation of the buildings, telling Latrobe that he had always been "well aware of all the importance of aspect, and have always laid it down as a rule that in drawing the plan of a house it's aspect is first to be known, that you may decide whether to give it most front or flank, and also on which side to throw passages & staircases in order to have the South, whether front or flank unembarrassed for windows." The site for the college, however, was "a law of nature to which we were bound to conform," he wrote. They had therefore made "our pavilions one room only in front, and 1. or 2. in flank as the family of the professor may require. in his apartments, or the best of them, his windows will open to the South. the lecturing room below has the same advantage, by substituting an open passage adjacent instead of a dormitory." The dormitories, he acknowledged, would not have the same southern exposure, but they would be outfitted with Venetian blinds and shaded by the "covered way"; besides, the pupils would be "in the lecture rooms for most of the day."¹⁸ Jefferson would design Pavilion IX so that it had two windows on each story of the south façade, but the stairway, rather than more south-facing windows, was located in the southeast corner of the building. Jefferson marked the upper right corner of his own drawing of Pavilion IX with the word "Latrobe," apparently crediting him with an important role in its design.¹⁹

Latrobe did not reply to Jefferson's August letter until early October 1817, when he sent him a drawing for the university. On it, Latrobe wrote, "you will perceive that the pavilions are only sketches, but they have been perfectly studied, & I can furnish drawings in detail of any of them which may please You."²⁰ Jefferson replied immediately, thanking Latrobe for "the beautiful set of drawings" and telling him that the Visitors, "having decided to build two more pavilions the ensuing season, we shall certainly select their fronts from these." However, some of Latrobe's designs for the fronts of the other pavilions required "too great a width for us," Jefferson explained; they were instead "obliged to give the largest dimension to our flanks which look North & South."²¹ The maximum width of the front facades was limited to 34 to 36 feet.²² Later that month Latrobe wrote Jefferson that "I hope you will do me the favor to let me know which of the pavilions you approve for your first work next spring; with a sketch of its dimensions and its plan, that I may send you the working drawings & the details at large."²³

HISTORY

DESIGN AND CONSTRUCTION OF THE PAVILIONS

Meanwhile, on July 18, 1817, Jefferson had begun the work of surveying the site, with a theodolite fixed at “the center of the Northern square on the point destined for some principal building,” the location where the Rotunda would later be erected. The land was divided into smaller rectangles, with each being “level within itself, with a pavilion at each end,” flanked by ten dormitories.²⁴ The next day he wrote John Hartwell Cocke, another member of the Board of Visitors, that “our squares are laid off, the brick yard begun, and the levelling will be begun in the course of the week.”²⁵ When the Board of Visitors met ten days later, they approved the “plan of the first Pavilion to be erected,”²⁶ and its cornerstone was laid in October. When the Visitors met that fall, they agreed that “the pavilions be correct in their architecture and execution, and that where the family of a Professor requires it, 2 additional rooms shall be added for their accommodation.”²⁷

In 1818, in a report written by Jefferson, the Rockfish Gap Commission recommended that Central College become the site of the University of Virginia, and this proposal was adopted by the Virginia senate early the next year. The commission’s report also noted that the pavilions should have in addition to the lecture room “two to four apartments for the accommodation of a professor and his family.”²⁸ Jefferson wrote in November 1818 that Pavilions III and VII were “nearly ready and as many will be erected the next summer as workmen can be procured to execute,” adding that “our buildings altho’ small, shall be models of chaste architecture.”²⁹

Immediately after the university bill was passed, Jefferson pressed his case for additional state funding so that additional construction could move forward during the approaching building season. He appealed to state Senator and Visitor Joseph Carrington Cabell in January 1819 to push for more state money; given the funds so far allocated, Jefferson told Cabell, “we shall be able to this present year to add but two pavilions and their dormitories to the two already in a course of execution, so as to provide but for 4. professorships; and hereafter we can add but one a year.”³⁰

The Visitors of Central College met a month later, on February 26, 1819, to prepare to turn over their responsibilities to their successors, the Board of Visitors of the University of Virginia. The Visitors of the college believed that it was important to push forward with construction in the months before the Visitors of the university held their first meeting; otherwise construction would be delayed. The Visitors of the college formally agreed in February that “it is expedient that all the funds of the University, applicable to the services of the present year, which shall remain after meeting all the other current & necessary purposes, shall be applied to the providing additional buildings for the accommodation of the

PAVILION IX

Professors, & for dieting & lodging the students of the University.” Given the “urgency of the advancing season,” it was very important, the Visitors further agreed, to contract with “workmen before they become generally otherwise engaged for the season.” More specifically, they recommended that “engagements may be entered into for building in the approaching season two more pavilions for the professors, one Hotel for dieting the Students and as many additional Dormitories for their lodging, with the necessary appendages as the said funds shall be competent to accomplish.” In addition, they went on record as approving “the propositions for covering with tin sheets the pavilions and hotels hereafter to be covered.”³¹

A round of criticism, however, came from an outgoing member of the Board of Visitors of the College, David Watson. Though realizing that he had been derelict in his duties by not visiting the grounds of the college since the foundation of Pavilion VII had been laid in 1817, Watson wrote another Visitor, John Hartwell Cocke, a few days after the February 1819 meeting that the “buildings are not upon a plan to meet my notions of convenience & utility.” Pavilion VII, he wrote, was “altogether unfit for the residence of a professor who has a family,” for the “cellar is barely sufficient for a kitchen; & where will meal, meat, & all the necessary articles of ordinary subsistence, which you can readily imagine, be kept?” Pavilion III, the second to be built, he admitted, “is larger, & of course less objectionable,” but he pointed out that “even that will be deficient in convenience.” He was also critical of the roofing: “I fear too that the flat roofs will leak, for I scarcely ever knew a flat roof in Virginia that did not.” Furthermore, he continued, the “interior of the pavilions are built too expensively. The floors, for instance, are too costly both as to materials and the manner of laying them.” “I am quite an ignoramus in architecture,” he admitted, “but I can *feel* what is convenient & inconvenient; and, by all our ardent prayers & wishes, let us not sacrifice the important, long sought object, for the want of suitable convenience in the plan of the buildings, & other arrangements.” “Mr. J. is sacrificing every thing to Attic & Corinthian order & chastity; about which I know nothing, & care almost as little,” he concluded, “tho’ I certainly should be pleased that the establishment should have an elegant & dignified appearance.”³²

The Board of Visitors of the University of Virginia held its first meeting on March 29, 1819. Among its first actions was to authorize a committee of superintendence, made up of Jefferson and Cocke, which was to appoint Arthur S. Brockenbrough as the proctor of the university. The Board assigned the acting proctor, Nelson Barksdale, the responsibility of inventorying the university’s real estate, listing both the completed buildings and “those which are in progress.” The Visitors of the University also confirmed a resolution that had been passed by their predecessors “that it is expedient that the funds of the University be

HISTORY

diverted as little as possible to the general engagement of the Professors required for the institution, until provision be made of buildings for their accommodation, & for dieting & lodging the students; and that the measures adopted by them for the buildings of the present year be approved & pursued.”³³

There was dissent among some of the Visitors about the plans for the university after the March meeting. Joseph Cabell, having communicated with Cocke and James Breckenridge, wrote Jefferson on April 17 that the “plan of pavilions and dormitories along the area of the University will be beautiful & magnificent, and unlike any thing which I have seen in Europe or America.” However, Cabell had reservations about the practical aspects of the spaces within the pavilions: “With respect to the Lecturing rooms in the pavilions,” he wrote, “permit me to ask whether a more spacious plan would not be advisable in the further prosecution of the buildings. Some of the Professors will probably not have crowded classes, and these might have the use of the Halls now finished or in a state of preparation. But many of the Professors will in all probability have very numerous attendants & the idea of repeating the same Lecture to the residue of a large class would be very disagreeable.” Looking ahead, correctly it would turn out, Cabell suggested that “In the lapse of years, it may be proper to resign the pavilions entirely to the accommodation of the Professors, and to provide Lecturing Rooms in separate buildings.” He, too, had reservations about the flat roofs: “it seems to be much doubted,” he wrote, “whether they will not leak, and require renewal in the course of six years.” Cabell also suggested that “some other style” be “adopted for the Hotels & back ranges.”³⁴

Joseph Cocke sent a letter to Jefferson that was carefully timed to follow on the heels of Cabell’s letter. In it Cocke praised the “Dormitories upon the upper level, connecting the pavilions,” and stated that the only change he would suggest would be that the “low pitched roofs concealed by a railing (upon the plan I once suggested)” might prove more economical and less likely to leak than flat ones, while at the same time rendering the “rooms more comfortable by keeping the Sun at a greater distance from the ceilings.” Cocke also enclosed his ideas for the areas behind the pavilions, including a scheme that combined a hotel and dormitories into a single structure and made the gardens behind the pavilions larger.³⁵ These two letters and a meeting of Jefferson and Cocke on May 12 at the university resulted in the postponement of construction of the first hotel until the Visitors could discuss the situation at their next meeting. Instead of the hotel, Jefferson wrote, they decided “to begin the Eastern range of pavilions,” explaining that those pavilions could be “used for hotels until wanting for the Professors.” Thus, he explained, “we are proceeding to have 3. pavilions erected on the Eastern range, with their appurtenant dormitories, in addition to the 4. built, or to be built on the Western range, so that we may have 7. pavilions, with

PAVILION IX

their dormitories, in progress this year, to be finished the next.”³⁶ Jefferson had not yet completed the designs for the East Lawn, but he nevertheless directed the proctor to begin the excavations for the basements of the east pavilions and their dormitories.³⁷

By late summer of 1819 construction of the university was moving ahead at a good rate. Arthur Brockenbrough had arrived in the spring; Jefferson told Cocke at the time that the proctor “relieves my shoulders from a burthen too much for them.”³⁸ Writing from his home at Poplar Forest on September 1, Jefferson gave Brockenbrough a good resume of the contracts for “the western range,” numbering the west pavilions consecutively from the north end (Pavilion IX was listed as number 5): “the Pavilion No. 1 the brick work was engaged to Carter and Phillips, the wooden work to Oldham; No. 2 is done with. No. 3. brick work and wooden work engaged to Dinsmore and Perry. No. 4. done with; and No. 5. not engaged.” With the contractors still busy with the intervening dormitories, Jefferson told Brockenbrough that when he returned from Poplar Forest, “we will decide according to circumstances whether to give” brick masons Carter and Phillips “Pavilion No. 5 of the western range, or one on the Eastern side.”³⁹

At their fall meeting, held on October 4, 1819, the Visitors affirmed the earlier decision of the committee of superintendence to construct “an additional pavilion” instead of a hotel during the 1819 building season. They also affirmed the committee’s “engagements for two other additional pavilions and dormitories, in anticipation of the funds for the ensuing year.” The proctor was directed to estimate the expense of completing the ten pavilions, five hotels, and additional dormitories.⁴⁰

In December 1819 Jefferson was able to report to the Literary Fund of Virginia, the recently established source of funding for public education, that the “walls of the 7 pavilions and 37 dormitories...have been completed, and their roofs are in forwardness to be put up in due time. Their inner and outer finishings will be the work of the ensuing year.” In order to accomplish this much, Jefferson explained, the Visitors had been “obliged to enter into engagements which will not only exhaust the funds of the present year, but pledge those of the ensuing one also; for two seasons being generally requisite for the accomplishment of good buildings, the one for their walls and cover, the other for inner finishings.” A year’s delay in authorizing a building would thus mean a delay of three years before it would be completed.⁴¹

Jefferson seemed pleased with the progress of the construction, even though the buildings were only “about half completed.” He wrote George Ticknor on Christmas Eve 1819, that the work at the university “goes on with much activity and hope, and will form an unique and beautiful Academical Villa[ge], in which every Professor will have a distinct house, or pavilion, to himself, consisting of a room for his lectures, with 4. others for family accom-

HISTORY

modation.” “These pavilions are of the best workmanship of strict architecture, intended as regular and classical models for the lectures on that subject. To each is annexed a garden and other conveniences. we fix the professors superiorly well in the hope of attracting them to the comforts of their situation, and by that means prevent their being seduced from us by other institutions.”⁴² On another occasion, when explaining the features of a pavilion to a prospective professor, Jefferson stated that the building “besides a large lecturing room, has 4. good rooms for family accom[m]odation, one of them below, large enough for your study & library; a drawing room & 2 bedrooms above. kitchen & servant’s rooms below.” He added that “the adjacent dormitories (14. f. square) can be used for your apparatus & laboratory.”⁴³

Nevertheless, the situation with the university’s funding wore on Jefferson, who wrote fellow Visitor James Madison in February 1820 that the “finances of the University are in a most painful state. the donation of 1820, is received & paid away, and we still owe 15,000 for work already done.”⁴⁴ Senator Cabell, however, was able to secure the consent of the General Assembly for a loan to the university from the Literary Fund.⁴⁵ At its April 1820 meeting the Board of Visitors had agreed that funds from the \$40,000 loan were to be used first to pay the university’s debts, including money owed to the contractors, and second to be put toward “the completion of the buildings now in hand.” Any balance was to be applied “towards the erection of three other pavilions & their accessory dormitories.” The Visitors also authorized the committee of superintendence to borrow an additional \$20,000 for the “erection of buildings of accommodation on the Eastern Back Street.” Jefferson asked the proctor to estimate the amount of funding that would be needed to pay outstanding debts and to complete all of the remaining construction except the Rotunda.⁴⁶ Pavilion IX was among the “three other pavilions” still to be built.⁴⁷

DESIGN AND CONSTRUCTION OF PAVILION IX

Thomas Jefferson prepared four studies for Pavilion IX, an elevation and three floor plans, arranged together on one modestly sized piece of engraved graph paper. On the back of the sheet are his specifications for the building, including his calculations for the extent of the walls, beginning with the “foundation below Kitchen floor,” the 8-foot height of the kitchen level, the 10-foot height of the rooms on the first story, and the “upper rooms, pitch” at 12 feet 6 inches. He also computed the height of the entablature, detailing the measurements for the cornice, frieze, and architrave. His notations indicate that he intended the classical order of the pavilion to be based on “adapting the Ionic with dentils from the temple of Fortuna virilis of Palladio” of ancient Rome. Similar calculations for Pavilion IX appear in Jefferson’s specification book for the University buildings.⁴⁸

PAVILION IX

At the top of the sheet of drawings for Pavilion IX Jefferson had written “Latrobe,” suggesting that Latrobe had provided the design of the façade including an entrance niche, an element that Latrobe had incorporated into his own designs. It has also been suggested that the entrance to Pavilion IX may have been influenced by the Hotel de Guimard in Paris, designed by Claude-Nicholas Ledoux and built in 1770. Latrobe may have drawn Jefferson’s attention to this building, but Jefferson would also have known of it through architectural books that he owned, including Johanne Karl Krafft’s book of plans and elevations of houses in Paris, which Jefferson purchased in 1804; it included a plate with an elevation, section, and plans of the Guimard house. He may also have become familiar with the house during his years in Paris.⁴⁹

Construction of Pavilion IX was well underway by the end of September 1820, when Arthur Brockenbrough submitted his report for inclusion in the university’s annual report to the Literary Fund. Included in the report was a payment of \$3,506.75 to contractors Carter and Phillips for “brick work last year in pavilions No. 1 and 5, and five dormitories, &c.” George W. Spooner was paid \$2,084.57 for “carpenter’s work on pavilion No. 5 west,” for a hotel and 10 dormitories, and for lumber. Master joiner John Neilson was paid a smaller amount, \$1,486.57, for “work and lumber for pavilion No. 5 west, and pavilion No. 5 east, with seven dormitories.” Peter Myers, another mason, did a small amount of brick work on pavilion 5 west for \$11.56. Apparently the roofing was also in place by that September, for A. H. Brooks was paid \$798.47 for “covering...with tin” Pavilion IX, along with roofing three other pavilions and installing pipes in another pavilion. Brockenbrough estimated it would cost \$18,000 to complete the “3 other pavilions now building,” including Pavilion IX.⁵⁰

Over the winter of 1820-1821 little construction work was done, the contractors being hampered by cold weather and by the university’s shortage of funds to pay them.⁵¹ Early in January 1821 mason John M. Perry signed an agreement with Curtis Carter to purchase for \$520 “all the bricks” belonging to Carter, along with a horse and stable, to finish the work that Carter had begun at the university, and to do it “finished in a nice and workman-like manner and have the work finished as soon as the season will permit him to do the same.”⁵²

A few days after the April 1821 meeting of the Board of Visitors, Jefferson wrote that the buildings for the professors’ “accommodation and that of the Students will indeed be completed in no great time,” although he feared not having the funds from the state to hire the professors to begin teaching.⁵³ Jefferson wrote to the Board of Visitors on September 30, 1821, giving them an update on the finances of the university and on the status of construction: everything was finished except for some of the dormitories, one pavilion and

IX. Ionic of temple of Fortuna Virilis

foundation below kitchen floor	$\frac{7}{2}$	measures from the level	
pitch of kitchen	8	to the floor	7
sleepers and floor	1		
lower rooms	10	lower rooms	10
joists and floor	1	joists and floor	1
upper rooms. pitch	$\frac{12-6}{34-6}$	upper rooms. pitch	$\frac{12-6}{25-6}$

The diminished diameter of the Tuscan, 12. I fix the module for the upper work, and altho' no columns above are intended, yet as they might be, and might have pedestals too, we are at liberty to take the height of an order entire of pedestal, column and entablature for the height of our upper story. adopting the Ionic with dentils from the temple of Fortuna virilis of Palladio, the whole height will be $2 \cdot 55 + 9 + 1 \cdot 56 = 13 \cdot 51 = 13 \cdot 10$
 the diminished diam. $5 \frac{1}{2} = 10.45$ or $10 \frac{1}{2}$
 $s' = 1$ and $i' = 2$

height of cornice	$47' = 9.4$
projection the same	
frize	$33 = 6.6$
Architrave	$36 = 7.2$
height of entablature	$111 = 11.1$
height of body	13.10
upper story	13.10

Ionic. Cornice	$6.47 = 6.47$
Frize	$33 = 6.6$
Architrave	$36 = 7.2$
Column & pedestal i.e. the body of upper story	$55 = 11.1$
Tuscan Order entire	$13.10.2$
Cellar & foundation walls below Tuscan base	9
Whole height from foundation	34.6

Note that in the draught of the elevation on the other side there is an error of 1.9 in the height of the Tuscan entablature which instead of 2.6 was laid down 4.5 only.

The 2. columns of the niche to be Tuscan of the height of the other Tuscan.

Thomas Jefferson's notes and specifications for Pavilion IX

PAVILION IX

three hotels, which would not be done until the spring. Also to be finished were the “Walls of backyards” and gardens.⁵⁴

When Jefferson submitted his next annual report to the Board of Visitors two months later, on November 30, 1821, he stated that six of the pavilions were then “in readiness for occupation,” along with 82 dormitories and two hotels; the remainder of the buildings, he wrote, would “all be completed in the ensuing summer.” The report showed expenditures for Pavilion IX included among expenses for other buildings: John Neilson had been paid \$2,861.87 for “wood work and lumber on Pavilions 9 and 10, and 7 dormitories,” and A. H. Brooks was paid for tin roofing on Pavilion IX and seven other pavilions, as well as on three hotels and 62 dormitories. In addition George W. Spooner was owed \$375 for “the wood work in part of Pavilion No. 9”; apparently his work was nearly complete because it had been “measured and bill made out.” Similarly, John Neilson was waiting to be paid for his services producing woodwork for Pavilion IX, as were Joseph Antrim for plastering and Edward Lowber for painting and glazing.⁵⁵

At their November 1821 meeting the Visitors agreed “to have an engraving made of the ground-plan of the buildings of the University including the library” and to have “so many copies struck off for sale as they shall think proper.” Engraved and printed in 1822, this would become known as the Maverick plan, and it showed Pavilion IX with its recessed doorway, central hall, and stairs leading from the rear of the hall down to the garden.⁵⁶

Meanwhile, Jefferson had been trying for more than a year to secure a detailed and accurate accounting from the proctor of the construction work that had already been done and an estimate of what would be needed to finish the buildings. He had explained the dilemma to John Cocke in April 1821: Brockenbrough had “kept only a general account with each Undertaker which does not enable us to know what each distinct building has cost.” The proctor had begun assembling the information, but Jefferson told Cocke that he did “not know whether this will take him a fortnight, or a month, or 6. months.”⁵⁷ At the end of September 1821 Jefferson had calculated the cost of Pavilion IX at \$7,360.63; in November 1822 the proctor’s accounts showed the cost to that point to be nearly the same, \$7,815.47.

In his annual report to the Literary Fund dated October 7, 1822, Jefferson stated that the Board of Visitors had “completed all of the buildings” that had been proposed in 1818, except one, the Rotunda. Included among the completed buildings was Pavilion IX, one of the “ten distinct houses or pavilions containing each a lecturing room, with generally four other apartments for the accommodation of a professor and his family, and with a garden, and the requisite family offices.” Also completed were six hotels and 109 dormitories. There was, Jefferson allowed, “still some plaistering to be done, now in hand, which will be

HISTORY

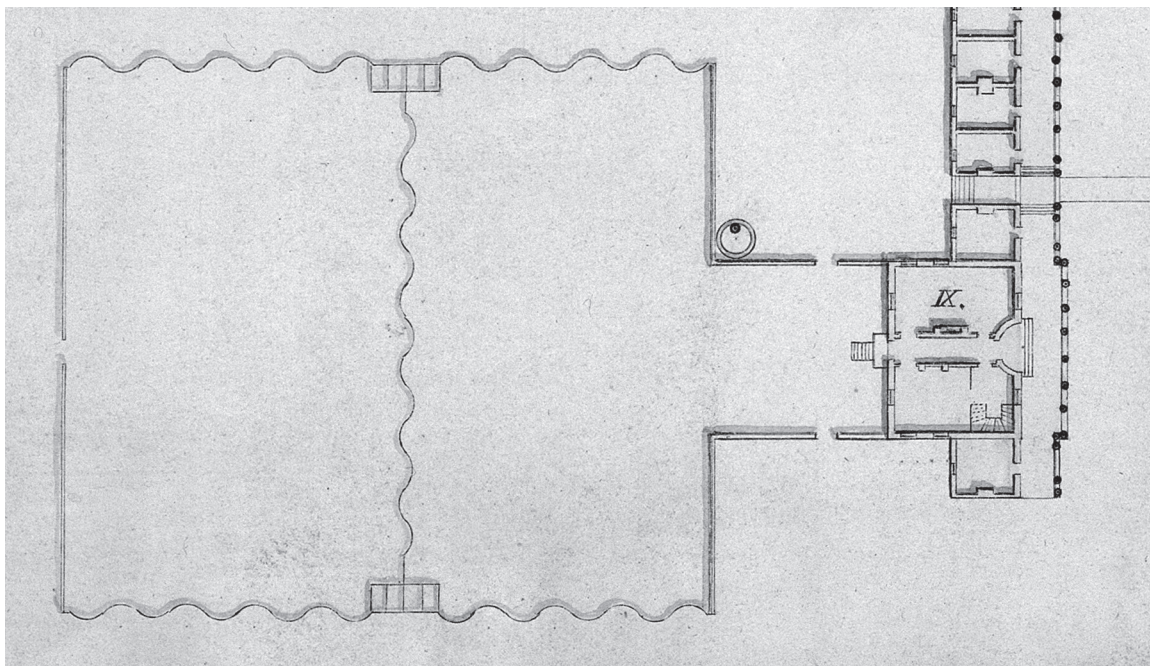

Detail of Pavilion IX from John Nielson's plan of the University of Virginia, circa March 1821

finished early in the present season, the garden grounds and garden walls to be completed, and some columns awaiting their capitals not yet received from Italy.⁵⁸

Included in the records of the proctor are itemized reports on the expenses for building Pavilion IX.⁵⁹ Curtis Carter and William B. Phillips, the brick masons from Richmond, were paid for three types of bricks: \$1,535.75 for 133,544 common bricks at \$.115 each, \$225.78 for 11,289 “oil stock” bricks at \$.20 each, and \$30.82 for 2,680 bricks for the “foundation of columns” (the oil-stock bricks, made by coating the copper-lining of wood molds with oil, were used in the front façade, where a smoother, more refined appearance was desired). John M. Perry, the brick mason who had purchased the remaining part of Carter and Philips’s contract, was paid \$55.49 for “brick work & paving” and an additional \$32.40 for “brick work for Cellar &c.” William B. Phillips, however, continued to work on the pavilion: he was paid \$48.42 for “Columns &c” and \$8.90 for “capping walls,” probably for the garden walls. Peter Myers was paid \$11.56 for “laying bricks & paving Cellar.” Hugh Chisholm was paid \$4.00 for “plaistering walls with cement,” perhaps the concave walls of the entrance niche. Joseph Antrim, who was responsible for plastering at the other pavilions and the Rotunda, was paid \$492.22 for his work at Pavilion IX.

PAVILION IX

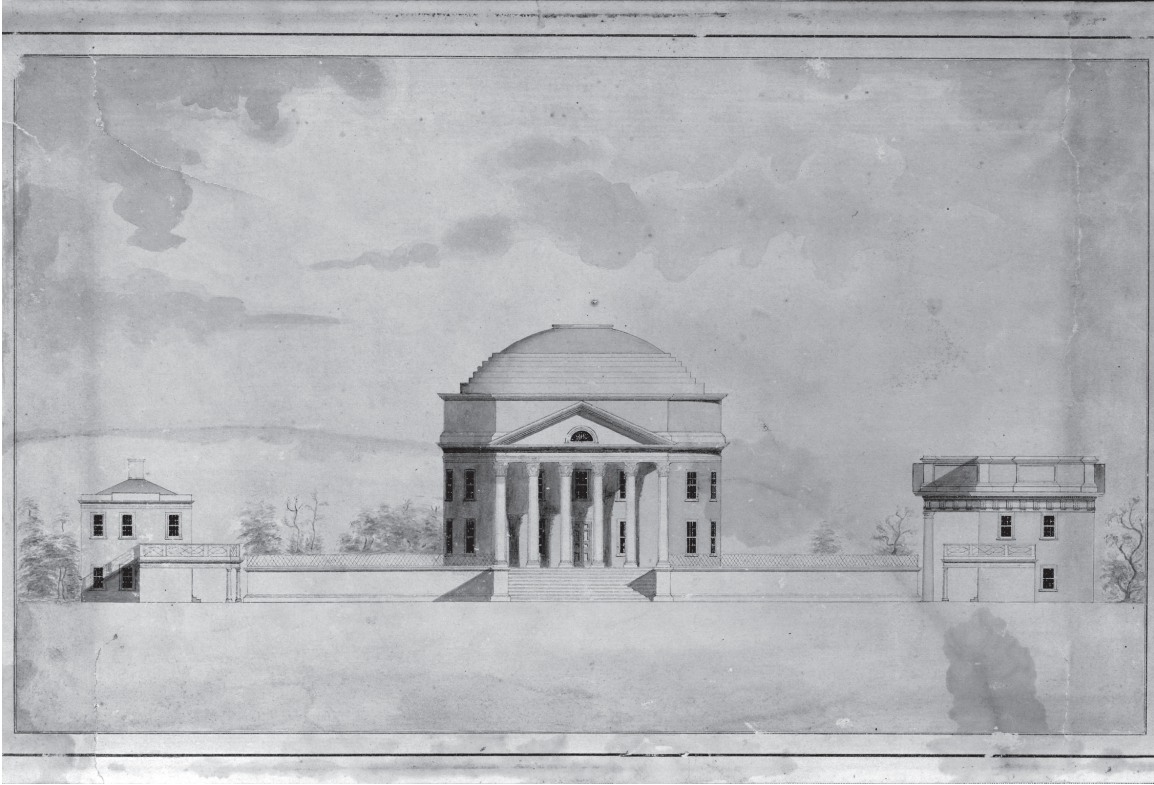

*Study of the Rotunda and Pavilions IX (to the left) and X (to the right), February 1823
This sketch has been variously attributed to Cornelia Jefferson Randolph,
John Neilson, and Benjamin Henry Latrobe; Neilson is now recognized as the artist*

Richmond-based Thomas B. Conway charged \$15.00 each for eight capitals and bases plus \$12.00 for transporting the stone by water and wagon. John Gorman, a stone mason from Lynchburg, was engaged to provide four “plain sills” and a “sill to steps” for \$28.57. Other stone work totaled \$227.46.

George W. Spooner was paid \$375.59 for “Carpenters work” and \$437.23 for lumber, but John Neilson, master carpenter, held the larger contract, being paid \$2,100 for carpentry and \$600 for lumber. The “Mahogany for the hand Rails,” which cost \$6.12 and was probably intended for the interior stairway, was procured from John Van Lew & Co., of Richmond. Peter Sturtevant, a wood carver from Richmond, was paid \$55.50 for “carving capitals for pavilion No. 9” in 1824, perhaps those at the front entrance.

A. H. Brooks was paid \$121.35 for his work on the tin roofing and nails; the 12 boxes of tin that were used cost \$168.00. Castings and iron for three stoves cost \$49.50, and John Gorman supplied “3 stove stones,” presumably for fire protection under the stoves,

HISTORY

for \$8.10. The cost of the iron sash weights was \$34.67. The smith's shop at the university provided a "crane iron," presumably for the kitchen fireplace, staples, and "1 Ketch for Door." Hardware consisting of locks, hinges, screws, nails, castings and other items totaled \$262.21. William J. Coffee, a sculptor based in New York, was paid \$39.00 for "Composition & Leaden Ornaments" to decorate the interior, most likely for the frieze in the professor's parlor on the second floor. Painting and glazing done by Edward Lowber cost \$406.82.

The accounts also detailed work done in the garden. Phillips was paid \$205.44 for "Brick work in Garden Walls," and Gorman provided 13 feet of "capping to wall," probably for the garden wall, and four "gate blocks." Samuel Campbell was paid \$12.61 "for stone work in area & Garden Walls," likely for the areaway along the north foundation wall. Perry supplied "6,804 bricks in back walls" for \$68.04 and 8,275 bricks for the "serpentine wall" at a cost of \$91.02.

A sum of \$426.04 shown in the accounts for "Labour including diet & Clothes" may have included charges incurred for slaves. Also billed to Pavilion IX were such overhead expenses as office supplies, postage, travel expenses, services of university personnel such as the proctor and bursar, and shipping. The total cost for Pavilion IX shown in the proctor's ledger as of September 1825 was \$8,807.04.

The Visitors' annual report for 1823 had stated that the outstanding work had been done by that time and that the "whole of these buildings are now in perfect readiness for putting the institution into operation."⁶⁰ Financial concerns and the strategic decision to complete the Rotunda before beginning classes, however, delayed the opening of the university for more than another two years, until March 7, 1825.⁶¹ The first occupant, would take up residency in Pavilion IX in that year.

1825-1846, GEORGE TUCKER

The first professor to occupy Pavilion IX was George Tucker, who was born in Bermuda in 1775.⁶² Tucker, who came to Virginia at the age of 20 to study law at the College of William and Mary, stayed, and became a legislator, serving first in the Virginia General Assembly and later in the United States Congress for three terms.⁶³ A member of the original faculty of the University of Virginia, he became the first chairman of the faculty and a professor in the School of Moral Philosophy, teaching a number of subjects, among them ethics, statistics, rhetoric, and political economy.⁶⁴

Tucker later wrote in his autobiography that upon starting his career at the university, his family "consisted of my son + three daughters, of a sister + her daughter whom I had invited over from Bermuda, after the death of my wife, and in the spring of 1825, I took



Engraving (above) and detail (left) showing Pavilion IX by Benjamin Tanner, 1826, based on an 1824 drawing

HISTORY

possession of the Pavillion [sic] at the University assigned to my chair.”⁶⁵ In that year he also attended the dinner with Lafayette at the Rotunda, at which Tucker “had the pleasure of treating him to some fine old Madeira that I chanced then to possess, & which he relished very highly.”⁶⁶ Tucker remarried in 1828.⁶⁷ The proctor’s ledgers show that he rented one or more dormitory rooms beginning in July 1829, possibly those adjacent to his pavilion.⁶⁸

In 1826, shortly into Tucker’s residency, the Board of Visitors noted that “some small additions are also necessary for the better accommodation of the Professors in their Pavilions, and of the students in their Dormitories, and for a few other minor objects.”⁶⁹ Some small improvements were made to Pavilion IX in 1826, amounting to \$6.87.⁷⁰

Three years later, in 1829, the Board of Visitors specifically directed the proctor of the university to “make an alteration in the Pavilion now occupied by Professor Tucker, by an addition to the west front, extending the whole length and elevation of the building, and about ten feet in width,” with the provision that “if, in the opinion of the committee the funds of the institution will not now justify the expense, the original cost, with the assent of Professor Tucker, shall be paid by him, to be refunded with interest, as soon as convenient.”⁷¹ It is possible that this addition was not immediately erected, for in 1831 the executive committee resolved to have built “in the rear of Professor Tucker’s and professor Harrison’s pavilions, offices upon the plans indicated in their written applications submitted to the Visitors at the present meeting.”⁷² Apparently the addition had been made by July 1832, when the minutes of the Board of Visitors meeting referred to “an addition to the basement story for the accommodation of Domestic” that had already been built at Pavilion IX.⁷³

In 1832 Tucker, in his role as chairman of the faculty, ordered the whitewashing of dormitories and cellars that had been occupied. He also advocated greater attention to cleanliness in the kitchens, privies, and other parts of the university as a precaution against cholera, whose “malignity,” he said, “can be greatly mitigated by timely precautions steadily adhered to.”⁷⁴ By 1833 work was underway on the water system at the university, and the executive committee of the Board of Visitors directed the proctor to “cause the line of wood pipes connected with the water works to be repaired, and the cistern near Professor Tucker’s pavilion to be completed, and to open an auxiliary supply of water to the cistern next the Lawn, by means of iron pipes connected with the gutters around the roofs of the neighbouring buildings.”⁷⁵ Work around Pavilion IX continued, including repairs to “the roof of the Dormitory on the South Side of Professor Tucker’s pavilion.” The Board of Visitors was reminded to reimburse Tucker for his outlay for repairs and changes, although no details of the work were given. The minutes from August 1837 also referenced the addition, mentioning “the changes & additions now making in the rear of pavilion N°.

PAVILION IX

9 by directions of the professor occupying the same” and including a resolution “that the addition to pavilion N^o. 9 occupied by Professor Tucker which was authorised by a former resolution of this Board and has been recently commenced under a contract made by M^r. Tucker be conducted under the direction of the Proctor subject to the control of the Executive Committee. But this order is not to commit the Board for payment or reimbursement otherwise than they are pledged by the former resolution.” In 1840 repairs were made to window glazing throughout the university, including the eight 12 x 12 lights and six 12 x 18 lights at Pavilion IX.⁷⁶ A later report stated that:

a small addition was made to the rear of the pavilion from an existing exterior porch. The addition created several new rooms on the [ground] floor, and a large covered porch on the [first] floor – perhaps in compensation for the lack of a covered porch in front.

The addition not only expanded what had become very cramped quarters, but also resulted in one of the pavilion’s most attractive interior features – an enormous elliptical arch at the west end of the dining room, with an exaggerated keystone at its center.⁷⁷

Tucker resigned in 1845, noting in his autobiography that this decision was due in part to the fact that the other faculty members were all much younger and that he “had no intimate companions” after the resignation of friend and relative Henry St. George Tucker.⁷⁸ The Board of Visitors passed a resolution in 1845 allowing both Henry St. George Tucker and George Tucker “to occupy their respective pavilions and Dormitories, or other buildings now in their occupancy, until the same may be required by their successors- and that those gentlemen have the usual access to the library, while they remain at the University.”⁷⁹ George Tucker later moved to Philadelphia, noting in his autobiography that he had emancipated “my household servants,” who had presumably been with him at the university and “who had been reared + partly born in my family.”⁸⁰ Tucker died in 1861 at the age of 86 as a result of injuries sustained during a tour of Mobile, Alabama. He was buried in the University Cemetery in Charlottesville.⁸¹

1845-1873, WILLIAM H. MCGUFFEY

By the late 1840s the effects of time and use were beginning to take their toll on the university’s facilities. In December 1847 the tin gutters of the pavilions, dormitories, and other buildings throughout the grounds required repairs totaling \$93.26.⁸² The annual reports from this time chronicle the need for major improvements not only to the water systems but also to the terraces—the combination roof and walkways over the colonnades in front of the pavilions and dormitories. The terraces were bordered by trellis railings that Jefferson had designed.⁸³ The 1853-54 annual report, issued when the annex to the Rotunda was being built, noted that:

HISTORY

the terraces in front of the pavilions and dormitories along the lawn are much decayed, and require immediate and extensive repairs. This damage has been the more rapid of late years, by reason of the large drafts upon the funds for the erection of the new building, and the consequent inability to apply adequate funds to timely renewals and repairs. Longer delay would be attended with great inconvenience from the leakage of rain water through the plastering below, and with great danger of destruction to the buildings from the falling of sparks of fire upon the decayed planking above. The same cause has prevented the adoption of efficient means to introduce a more adequate supply of water within the precincts—a measure of such importance as to be considered indispensable to the perfect safety of the buildings.”⁸⁴

Apparently making these repairs took longer than expected, as the 1854 annual report stated that “the work of repairing the terraces and of procuring a better supply of water at the university, has not yet been commenced. But preparatory steps have been taken, and these important improvements will probably be in active progress in the course of a short time.”⁸⁵ On May 31, 1855, the executive committee entered into a contract for “the reconstruction of the terraces.” The Board of Visitors planned

to use, in aid of the reconstruction, such portions of the wooden trellis railing, bordering the present terraces, which might be found to still be standing in a sound state, and with a view to greater durability, and better protection from fire, to sheathe the flooring of the new terraces with an upper coating of sheet copper. But the committee, being invested with the authority to modify the plan, subject to a limit of \$10,000 on the amount to be expended, and having discovered, upon careful investigation, that there was but little of the existing railing in a sound state, and that a covering of sheet copper would be very costly, and at the same time not durable and permanent as a walk, finally decided to change both these features in the original design— substituting for the wooden trellis an iron railing, and for the copper sheathing a heart pine floor, well tongued and grooved, with its upper surface protected by a series of three coats of white lead paint, surmounted by an equal series of coats of Bridgewater paint, with an interposition between the two series of a coating of the best twilled duck or canvass, well rolled and incorporated with the painting. It is anticipated that a superstructure over the colonnades of the lawn, thus prepared, will be impervious to water, and of great duration.⁸⁶

In June 1855 the Board of Visitors reported that the work was being undertaken:

Upon the subject of the terraces the committee were more successful. An advantageous contract was made with George W. Spooner for the entire work, within the limit proposed, and for a less sum, to be completed by the 1st day of December next. . . This however could not have been accomplished but by dispensing with the copper covering and substituting in lieu of it, a covering of heart pine plank of the best description [sic] well seasoned and tongued & grooved, with seven coats of paint, and a final covering

PAVILION IX



*Engraving of the University of Virginia, 1843-1845,
attributed to Henry Howe*

of duck or canvass, to render it secure against all weather. For this latter work a contract was made with James F. Boyer, at a reasonable price he being the lowest bidder therefor... In the progress of the business and preparatory to entering into any contract for the work to be done, it appeared important to your Committee, indeed indispensable that they should have the aid of some schilful [sic] person in examining in detail the various bids and estimates, which had been submitted to the Committee, and enabling them to decide in the first place upon the relative merits of each bid (of which it was not to be expected they were competent to judge in finally contracting for the work) and with that view they proceeded to engage the services of Mr Shaw a skilful engineer [sic] and practical man of business... It was moreover apparent that the work under any contract they could make, could not be satisfactorily and safely done without such a superintendent well qualified to judge of the timber and work, and who would be able to superintend the whole work as it was in progress, from its commencement to its final completion, for this your Committee agreed to allow Mr Shaw the sum of \$400, which they regard as a reasonable compensation for the services to be performed by him.⁸⁷

Later that meeting Mr. Stevenson for the Committee of Inspection reported that:

HISTORY

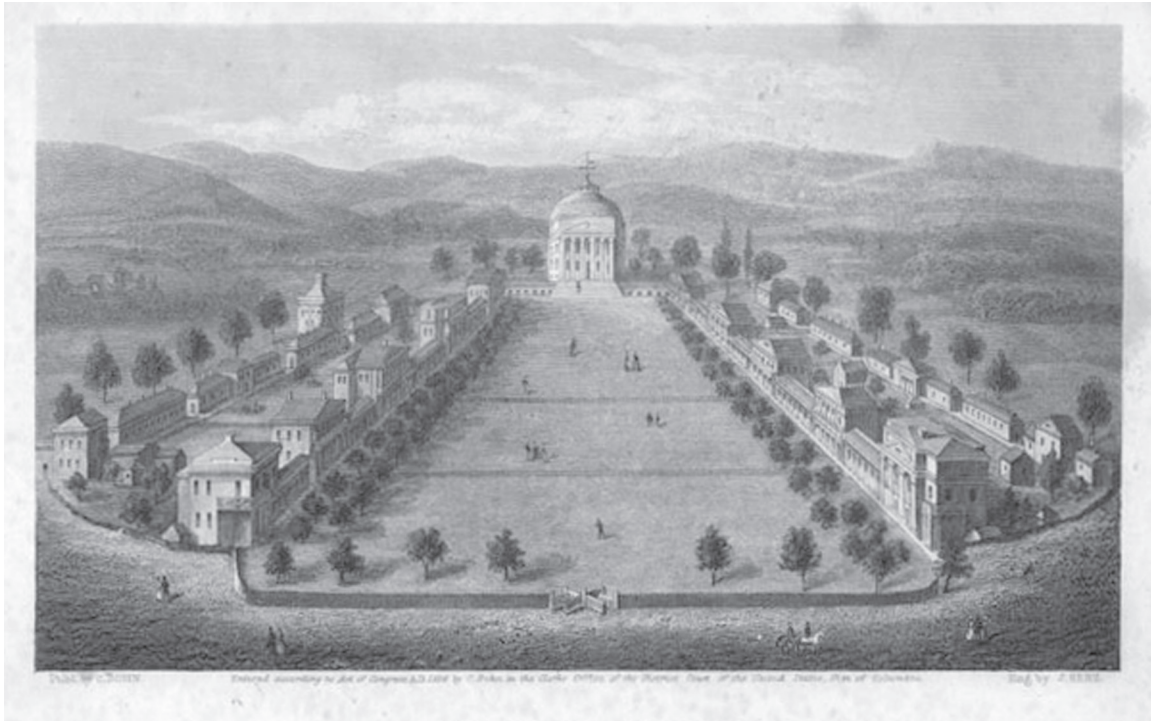

*Engraving of University of Virginia by J. Serz,
published by C. Bohn, 1856*

In examining the buildings the Committee found great delapidation [sic] and injury in many of the buildings and especially in the dormitories and the ceiling of the terraces, this last however will soon be remedied, by the contemplated repairs of the terraces. They find the public water closets in a very filthy state and a perfect nuisance endangering the health of the students, and even of those who reside within the limits of the University. The grounds also seem to have been greatly neglected, and are in a wretched state, It is an act of justice to the Proctor to state, that he informed the committee, that he had not the means nor experience requisite to keeping them in order, The Committee are decidedly of the opinion that some remedy ought to be applied, and as a means of remedying the evil it might be advisable to separate the duties of the Proctor and place all the out door [sic] duties of his office under the management of a skilful man of business; by so doing your Committee are of the opinion that the evils referred to may be avoided, and the Buildings and grounds of the University properly cared for.⁸⁸

The annual report for 1856 stated that “the repairs of the terraces,” had been “nearly completed” by June of that year. As that work was underway, “it was found that the exterior portions of all the buildings and the interior of the dormitories greatly needed repaint-

PAVILION IX

ing, and that considerable repairs had become absolutely necessary on the cornices of the ranges.” The board therefore agreed to spend “\$6,000 for the repainting of the exterior of all the buildings and the interior of the dormitories, including the repairs necessary for the ranges.” This work was done during the summer of 1856.⁸⁹ The 1857 annual report noted that the General Assembly had appropriated \$25,000

for improving the buildings of the university, and for supplying it with water. Of this appropriation some five or six thousand dollars have been expended in repairs to the buildings, essential to their preservation, but not falling within the description of repairs incident to the ordinary use of property. The cornices, arcades, terraces, and other portions of the buildings mainly designed for architectural ornament, were found to require complete overhauling and refitting, and the whole exterior wood work repainting. All this has been done thoroughly, and the buildings are now in good order and preservation.⁹⁰

Even so, Pavilion IX still had some problems. The Board of Visitors minutes from September 1858 detail the poor conditions, noting that, along with the basement of the proctor’s house, the basement of Pavilion IX was “in a condition requiring more immediate attention than any others in the University.”⁹¹ In 1853 the sum of \$188.05 was spent to “fix up” the lecture room, and \$55.63 was spent on stove pipes.⁹² In June 1858 the bursar created a ledger entry for gas fixtures for Pavilion IX, but no dollar amounts were entered.⁹³ Regular payments for gas were made beginning in 1861 through the 1860s.⁹⁴ In 1865, reflecting the difficult conditions at the university during the Civil War, the Committee on Buildings reported that the roofs of the pavilions, as well as many other structures, were “in bad condition” and “required immediate attention”; the Executive Committee recommended prompt action.⁹⁵ There were also chronic problems with the plumbing and the water closet at Pavilion IX between 1868 and 1873, precipitating numerous repairs. The bath tub was also repaired in 1873, and the same ledgers show “carpenter’s work” in 1867 and 1868 in the amount of \$63.88, and \$28.30 spent on painting in 1870.⁹⁶

From 1845 through 1873 Pavilion IX was home to William Holmes McGuffey. Probably best known for the *McGuffey Eclectic Readers*, McGuffey taught moral philosophy at the University from 1845 until his death in 1873. Earlier he had served as president of Ohio University and then Woodward College.⁹⁷ He was one of the longest occupants of Pavilion IX and made good use of the buildings and grounds while there. Chronicles of his tenancy include accounts of the parties he gave for neighborhood children, making them into a sort of focus group for stories he proposed to include in his books by reading to the children under the ash tree in his garden. Known as the McGuffey Ash, it was taken down due to age in 1990.⁹⁸ The 1877 annual report noted that \$1,200.00 was expended on an addition to Pavilion IX between 1832 and 1865, with another \$36.22 spent between 1865 and July 1877.⁹⁹

HISTORY

1874-1903, WILLIAM E. PETERS

Although Pavilion IX was next assigned to Charles S. Venable, its subsequent resident was in fact Col. William E. Peters, who, like McGuffey, would occupy the building for a very long time.¹⁰⁰ A native Virginian and veteran of the Confederate Army, Peters had been a graduate student at the University of Virginia, and his return as a professor of Latin coincided with the division of the school of ancient languages and the establishment of a separate school of Latin.¹⁰¹ Peters originally occupied Pavilion III but began residing in Pavilion IX in 1874. He continued to live there until after his resignation in 1902.¹⁰²

Shortly after Peters moved into Pavilion IX, the Board of Visitors “had their attention directed to the decayed condition of the porch to the rear of Col. Peters Pavilion,” which had presumably been built for McGuffey, and they recommended an “appropriation of \$40.00 for the repair.”¹⁰³

On August 12, 1874, “a violent storm tore a large part of the roof” from the annex behind the Rotunda and caused other damage that required immediate outlays for repairs in the amount of \$325.00.¹⁰⁴ This storm may have exacerbated other problems that were slowly encroaching. The annual report from 1875, for instance, noted that the appropriation for repairs and improvements:

was cut down to the point *below* what is actually necessary to keep the extensive buildings and improvements in good thorough repair....The board has caused an estimate to be made of the amount which would be necessary to replace the worn out pavements, paint the buildings, add to the accommodation of some of the pavilions which are too small for the accommodation of any but very small families, and put the public property at the University in thorough repair, which has not been done since some years before the late war. For these purposes about \$25,000 will be necessary, and the sooner this sum is appropriated for that purpose the greater will be the economy of its application.¹⁰⁵

The same report notes repairs made to Pavilion IX, perhaps as a result of the previous year’s storm, in the amount of \$36.22, although the 1877 annual report lists this amount as being spent on the addition.¹⁰⁶

Coal had been used in the building for heating or cooking, or both. In 1877 two “Radiant Stoves” were installed and the fireplaces repaired.¹⁰⁷ In 1875 the blinds were painted.¹⁰⁸ There was work on the glazing on an almost annual basis between 1877 and 1893.¹⁰⁹

During the late 1870s extensive work was also done on the Lawn and the terraces. The 1878 annual report states that “In continuation of last year’s operations, almost the entire pavement of the University has been renewed, the brick having been burnt during the summer on our own premises. A good deal of new tin roof, and an extensive amount of roof-painting has been executed and all the usual repairs attended to.”¹¹⁰ The 1879 annual report provided these details:

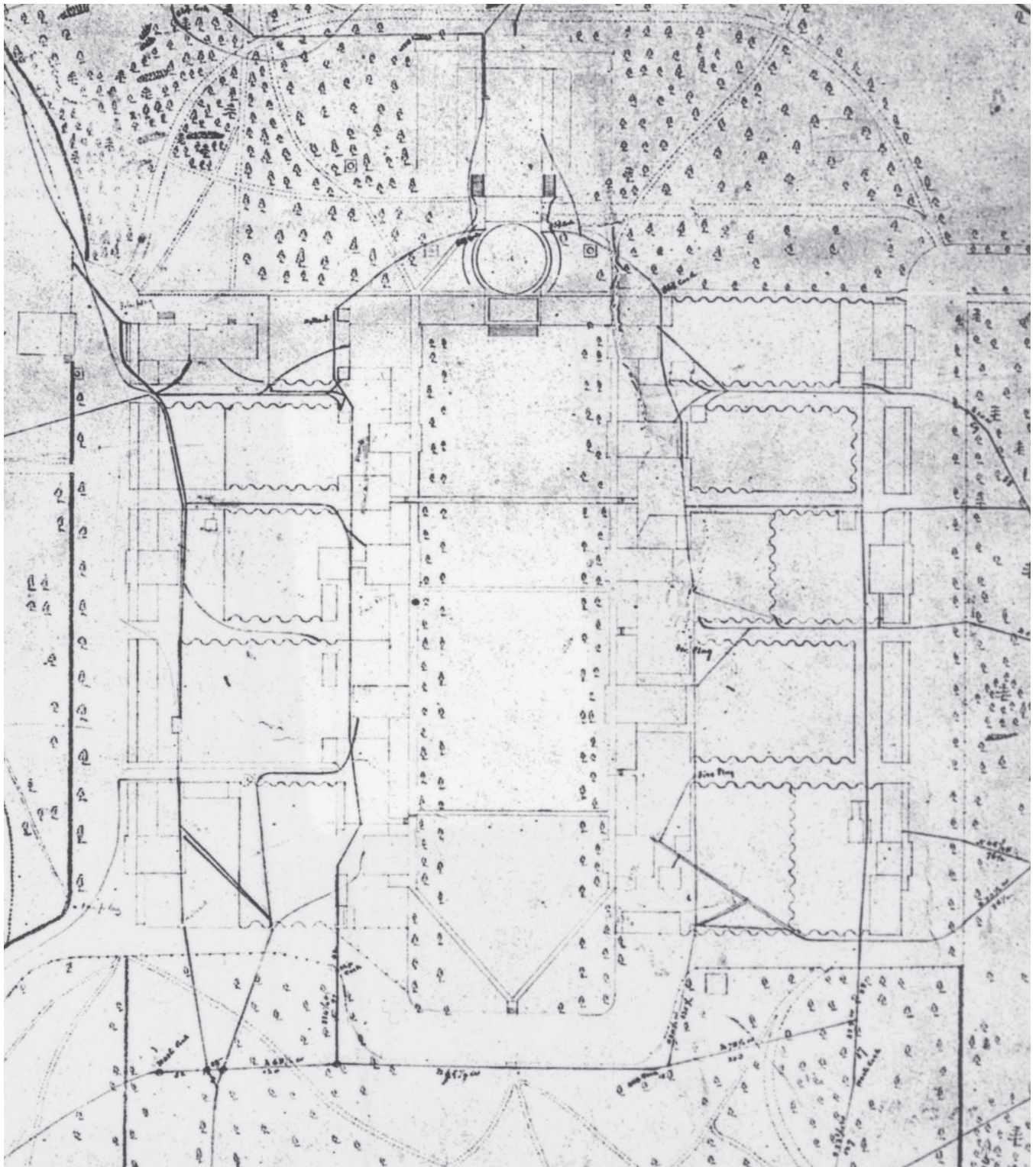

1870s utilities map of the Lawn

HISTORY

The lawn terraces, which were defective, have been recovered with metal roofs, which are secure and water-tight, at a cost of about \$1,000. The entire exterior wood-work of the buildings have been repainted, at a cost of \$1,500. ...and a complete system of tile-drainage of the lawn, which was essential for the comfort and health of the professors and students, has been introduced. The cost of all these improvements has been paid out of the general revenues of the University.

The fund for repairs and improvements has been devoted chiefly, as usual, to keeping in repair the extensive grounds and buildings of the University. The most important expenditure has been in rendering the terraces on the lawn water-tight, by means of an iron roof well protected by paint on all sides and by a slatted walk-way of wood. This improvement has rendered it possible to repair and repaint the ceiling and cornices of the arcades and porches, and thus make them decent for the first time in years.¹¹¹

However, by the early 1880s there were problems with even those features that had recently been the focus of repairs. The 1881-82 annual report states that “Even a careless observer...cannot fail to recognize in the present appearance of the University grounds and buildings many unsatisfactory indications. New buildings are needed, and the repair of many of the old cannot be wisely postponed...The sewerage and general system of drainage are incomplete and only partially subserve their purpose.”¹¹² Designer and civil engineer Ernest Bowditch summarized the issues at the University grounds: “Imperfectly drained land; imperfectly drained basements; faulty brick walls, and in consequence damp and wet plastering; insufficient and inconvenient sanitary arrangements; insufficient and impure water supply; inadequate and leaky sewers; wretched plumbing; very poor arrangement for care of rooms.”¹¹³

In the 1883-84 annual report, the Board of Visitors authorized the Executive Committee “to have contracted...the Bowditch system of sewerage, at a cost not to exceed \$20,000” and “to expend not more than \$250 in having a survey made for an additional water supply.”¹¹⁴ The same report notes that “Two deaths from fever have occurred—that of Mr. Doswell and of Mr. Antrim, both Virginians. Nevertheless, the general health of the students was better than usual, and we trust that with the completion of the system of sewerage and drainage, now nearly done, the cause of sickness at this place will be almost, if not altogether, removed.”¹¹⁵

The 1884-85 annual report stated that “the sanitary condition of the dwellings and other buildings in the University was alarmingly bad, owing to the extreme dampness of the basements, which having existed since their first construction had caused a most wasteful decay of materials with serious results as to the health of the community and with threatening consequences as to the integrity of the entire structures.” The sum of \$20,000 was originally appropriated for the construction of a sewer system, and in the fall of 1884 the sum of \$5,500 was added to the budget. The report continued:

PAVILION IX

It should be borne in mind that these buildings were constructed at a time when the manifold dangers of damp foundations were not understood. It is now a recognized canon of sanitary science understood by competent architects and the general public almost, as well as by sanitary engineers, that damp basements are a fruitful source for disease, and that if a subsoil in the foundation of a dwelling be at all damp, it should be effectually drained. All the dwellings in the University have cellars excavated in a very damp clay soil, and these constitute a considerable portion of the accommodations provided for the families occupying the houses. No means of drainage were supplied, and no water-proof courses were laid in the foundations. The basement rooms thus necessarily became nests for the generation and development of diseases caused by soil dampness, and were also largely influential in intensifying the malignity of imported infectious fevers.

The amounts appropriated for the needful sanitary repairs and improvements, being all that was available, was yet found to be far short of what would be required for thorough local sanitation, and for renewing decayed structures. To complete work actually commenced, the cost of which could not be accurately ascertained in advance, as each step revealed further defects, it was found necessary to exceed the amount appropriated by nearly fifteen hundred dollars which has yet to be paid, and very much work of a similar nature urgently needed has been necessarily postponed for want of means.

The most beneficent results may confidently be anticipated from the completion of the sewers and other sanitary works. The sewers are completed and have been in successful operation ever since an adequate supply of water to flush them has been obtained. Typhoid fever will doubtless be occasionally introduced in the future as in the past by students coming from various parts of our extended country, but there is every reason to hope that such isolated cases will never again initiate outbreaks within the precincts.

Sewerage without an abundant water supply, is but a delusion and a snare, being nothing more than elongated cesspools. In the last annual report of this Board, a detailed account was given of the then existing state of the question as to the possible alterations then under consideration. It is a matter of congratulation that the authorities of the town of Charlottesville finally decided to combine with the University, and procure a supply of pure water from mountain streams, at a distance of five or six miles, abundant in quantity, and from such an elevation as to insure its delivery by gravity to the tops of the houses in both places. A reservoir of ample dimensions for the storage of a year's supply, and the delivery pipes, have been finished, and the works are now in successful operation. The amount paid by the University to date, (November 24, 1885,) is \$20,177.57.¹¹⁶

The 1884-85 report also commented on the effects of deferred maintenance:

The property of the state at the University is estimated to be worth \$1,000,000. From continuous lack of means since the war, the buildings have fallen into a state of serious disrepair: and it is much desired that ways and means may be devised by which all the

HISTORY

buildings may be put in good and thorough order, so as to save the property from further injury. it is only proper to say that the utmost has been done with the small means at command, from year to year, to preserve the property of the state held here in trust by the Rector and Visitors.¹¹⁷

In 1884 the Board of Visitors directed the proctor “to have repairs to pavilion, No 9, recommended in Faculty Report, done by hiring workmen by the day and furnishing material for same”¹¹⁸ The ledger for 1884-85 lists work done on the porch and the glazing, mostly in August, but some aspects of the work continued into the late fall, totaling \$199.36. The majority of the vouchers were made out to G. S. Ford, although labor was also provided by Karn & Hickson, J. J. Montague, J. B. Hawkins, J. Bishop, and Chris Dunbar. The 1884-85 annual report also noted repairs required for the porch.¹¹⁹

The plumbing also continued to be a problem throughout Peters’s residency. Ledgers from 1874 through 1887 reflect repeated repairs to the water closet and pipes.¹²⁰ A gas fixture also required repair in 1888.¹²¹

The seemingly endless work of making sure that the physical appearance of the university appropriately reflected its reputation and stature continued. The 1887-88 annual report revealed that:

A contract was made last spring by the Board with an electric light company by which the latter was authorized, at its cost, to introduce, protected incandescent light in the grounds and public buildings, with the view of testing the claims of this mode of lighting, as to quality, safety, and cost, when compared with gas or oil. The result proved that a much superior light could be obtained from this mode of lighting for the grounds, public buildings, and students’ dormitories, and at a cost little, if any, above that required for gas or oil. The Board then made a contract with said company, to be executed under the supervision of the Faculty, for supplying this electric light to the grounds and public buildings and to the dormitories. The entire expense of laying the wires and supplying the lamps to be borne by said company, and this mode of lighting will be ready for use at the opening of the next session.

The increase in the water-supply, with the improved system of sewerage recently provided, and the careful attention paid to the police of the grounds, and other sanitary precautions, have contributed to maintain the health of the students in a gratifying degree.¹²²

The 1888-89 annual report observed that “absolutely necessary repairs, for the most part to roofing...had made it impracticable, with the limited repair fund, to keep the sidewalks and roadways in such a state as the dignity of the institution would seem to require”; the Visitors “hoped that increasing numbers will enable the Board to appropriate more money for this [repair] fund and rid the institution of the poor pavements and roads that most

PAVILION IX

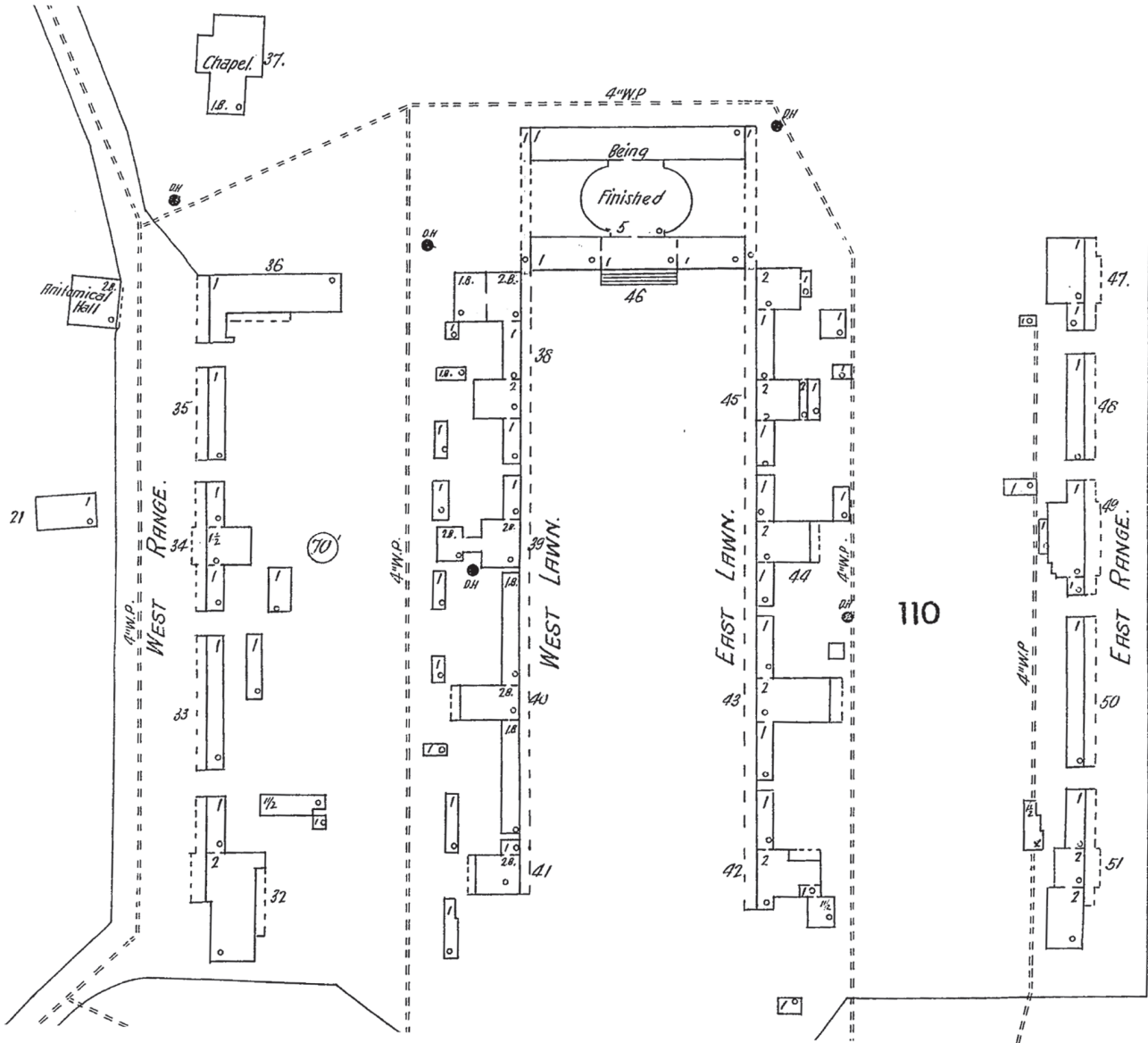

Sanborn map of the Lawn, 1896

HISTORY



This view of the Lawn from the south, taken by McKim, Mead, and White in 1896, shows a glimpse of Pavilions IX and X

impress strangers unfavorably.”¹²³ The 1889-90 annual report noted that “*Improvements in grounds and buildings* made, and in process of construction, since the last annual report have been extensive, and have added greatly both to the appearance of the University and to the comfort and convenience of its members. The largest item is the new pavement of the lawn with artificial stone—a handsome and, it is hoped, a durable improvement in the much worn brick pavements heretofore in use there...new galleries have been built; Venetian blinds added for doors and windows, and the whole quarter completely renovated. New roofs have been put on two of the professors’ pavilions.”¹²⁴ The 1890-91 annual report revealed that “\$4,167.70 for repairing the lawn sidewalks in a handsome and durable manner” had been authorized, and an additional \$184.23 for water pipes and sewers was also recorded. Another \$285.40 was spent on water pipes and sewers the next year.¹²⁵

1905-1927, THOMAS FITZ-HUGH

By the turn of the twentieth century the Board of Visitors finally felt that the state of the buildings and grounds suitably reflected the prestige of the institution. “The University has the reputation of being the most beautiful College in the world, in its grouping of

PAVILION IX



Pavilion IX from the south, 1900, showing the southwest addition

architecture, grounds and scenery,” stated the Board of Visitors minutes from June 1905, “and is visited by many persons in the summer months particularly, and all the year in the intervals of trains passing.”¹²⁶ The same minutes also recommended the finishing of the “granolithic walks,” first north of the Rotunda and then “South of the Rotunda, extending from residence of Prof. Lile on East Lawn, around the Quadrangle to the residence of Prof. Fitz-Hugh on West Lawn.”¹²⁷

Thomas Fitz-Hugh, a native Virginian who had moved into Pavilion IX in 1905, was a professor of Latin, whose appointment was recommended by his predecessor, Professor Peters.¹²⁸ Fitz-Hugh retired from the faculty in 1930 but stayed on in Charlottesville until 1952, when he moved to Philadelphia to join his son.¹²⁹

1930-1933, JOHN NEWCOMB

In April 1929, before John Newcomb moved into Pavilion IX, the Board of Visitors appropriated “out of the accumulated income from the DuPont bequest” \$20,000 to cover the removal of two buildings at the university and the “reconditioning” of several others, including Pavilion IX.¹³⁰

HISTORY



Pavilion IX, circa 1900-1910, by the Detroit Publishing Company; note the southwest addition with the doorway in the south elevation, and the shutters in the arch of the recessed entrance niche

Newcomb, the dean of the School of Engineering, occupied the building for only a few years before being appointed the second president of the university.¹³¹ He was yet another occupant of Pavilion IX who was also a native Virginian, having been born in Sasfras, and was a graduate of the College of William and Mary.¹³² He was married, but obituaries mention no children.¹³³

1934-1939, JAMES C. FLIPPIN

Occupancy of Pavilion IX next passed to James Flippin, dean of the Medical School and professor of internal medicine. His stay in the building was also brief, although for an unhappy reason; Flippin died unexpectedly of a heart attack at the age of 61, succumbing in the building that was his home, leaving a wife and son.¹³⁴

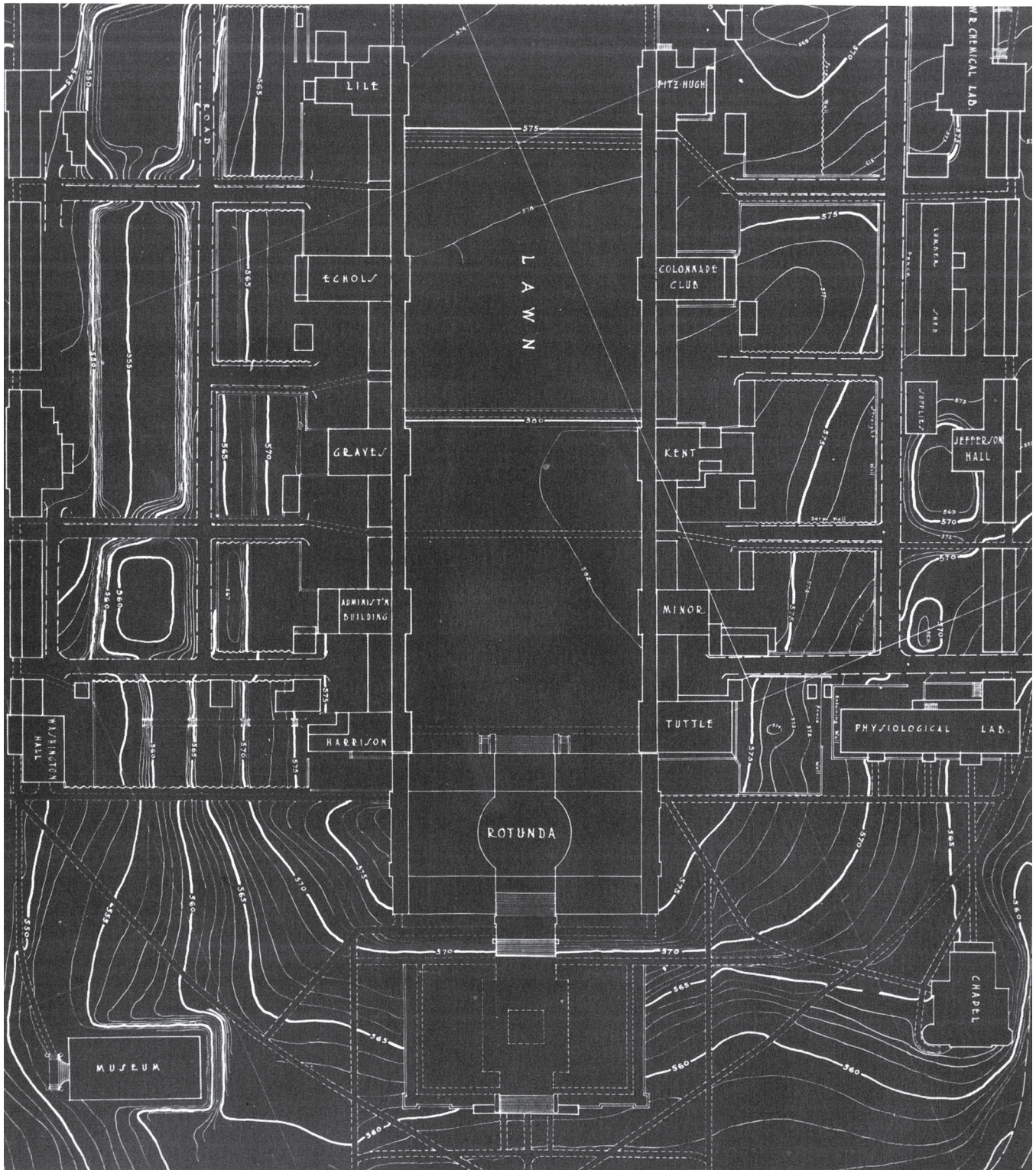

Detail of topographical map of University of Virginia, 1909

HISTORY

1940-1948, L. G. HOXTON

Pavilion IX was next occupied by Llewellyn Hoxton, chairman of the Physics Department, who lived in the building until his retirement in 1948.¹³⁵

1949-1962, ATCHESON L. HENCH

In the early 1950s the Committee on Buildings and Grounds reestablished and clarified the conditions under which the residents of the pavilions were chosen.¹³⁶ In 1960 these decisions were revisited and revised.¹³⁷ During this period Pavilion IX was occupied by Atcheson Hensch, who taught Middle English and Chaucer and became a president of the Bibliographical Society of Virginia.¹³⁸ Reportedly during Hensch's occupancy, a bathroom was added in the southwest corner of the first floor for his mother-in-law, who was bedridden.¹³⁹

1963-1977, ROBERT J. HARRIS

In 1962 Pavilion IX was assigned to Robert Harris, a professor of political science and the dean of the faculty of arts and sciences.¹⁴⁰ The kitchen was reportedly enlarged onto the back porch during this period.¹⁴¹

1977-1982, NORMAN J. KNORR

Norman J. Knorr, the dean of the School of Medicine, was assigned Pavilion IX in 1977. At the beginning of the 1980s repairs of both the interior and exterior of Pavilion IX were undertaken. According to an article in the *Cavalier Daily*:

In 1983, the columns were relieved of over 30 layers of white paint and repainted, along with the pavilion's doors.

Also restored at that time was the entablature around the pavilion's roofline. A tiny dentil molding, the only ornamentation to be found on the roofline entablature, is repeated in a second entablature that surrounds the base of the entranceway's semi-dome. . .

During the restoration, paint was stripped from all the pavilion's windows, exterior doors and mantels, to be reapplied after careful study of the various layers. A majority of the living room floor, which had been nearly destroyed by termite damage, also was completely replaced at this time.

In addition to the interior repairs. . . , a new slate roof was added to the pavilion.¹⁴²

PAVILION IX



Detail from panoramic view of the Lawn by Rufus Holsinger, circa 1911



Detail from panoramic view of the Lawn by A.C. Brechin & Son, circa 1911

HISTORY

1983-1990, ROBERT KELLOGG

The first resident of Pavilion IX after its renovation in the early 1980s was Robert Kellogg. Kellogg was a professor and chairman of the English department, which he headed for four years before being appointed Dean of the College of Arts and Sciences in 1978.¹⁴³ He stepped down as dean at the end of the 1984-85 academic year and returned to teaching full-time. He remained in Pavilion IX with his wife, Joan, until 1990. The Kelloggs decorated the interior with artwork and artifacts from Iceland, where they had a second home.¹⁴⁴

1990-1994, HARRY PORTER

Harry Porter had been recruited by the School of Architecture in 1969 to establish a Department of Landscape Architecture and was its first chair. He had a master's degree in landscape architecture from Harvard University and had taught at Harvard and the University of Michigan. Porter became dean of the School of Architecture in 1989 and was the first dean of that school to live in Pavilion IX. He was a Fellow of the American Society of Landscape Architects and an honorary member of the Virginia Society of the American Institute of Architects.

In 1992 Porter became the first University Architect in the newly created Office of the Architect; in that post he advised the Board of Visitors on the "design and development of the University Grounds." He retired in 1994. Porter is honored at the school both through an endowed visiting professorship in architecture and with the ash tree that was planted in front of Pavilion IX in 1999.¹⁴⁵

1994-1999, WILLIAM A. MCDONOUGH

William A. McDonough resided in Pavilion IX between 1994 and 1999, when he was the Edward E. Elson Professor of Architecture and dean of the School of Architecture; he was known as an internationally known architect, activist, and innovator in environmentally conscious building and design. His firm, William McDonough + Partners, relocated to Charlottesville in 1994 and became a leader in sustainable design. McDonough served as an advisor to President Bill Clinton's Council on Sustainable Development and in 1996 won the Presidential Award for Sustainable Development. He continues to participate in the school as a distinguished lecturer in sustainability.¹⁴⁶

In 1998, while McDonough was residing at Pavilion IX, the engineering firm of Whitlock Dalrymple Poston and Associates conducted an investigation of the condition of the



*A rare view of Pavilion IX from the west, taken in September 1951
when a new serpentine garden wall was constructed*

HISTORY

colonnade, including the terrace at Pavilion IX. This survey followed WDP's study of the collapse of the balcony at Pavilion I in 1997. In the study of the colonnade, WDP examined each element of the railing, identifying areas of deterioration or structural weakness.¹⁴⁷

1999-2010, KAREN VAN LENGEN

Pavilion IX was next occupied by Karen Van Lengen, the William R. Kenan, Jr., Professor of Architecture and former dean of the school. She occupied the house with her young daughter, with whom she would often play in the gardens behind the pavilions, and her husband, James Welty, a sculptor, whose work was placed in the pavilion and the garden.¹⁴⁸

In 2007 the University and Mesick-Cohen-Wilson-Baker Architects investigated the accuracy of the 1970s restoration of the terrace's Chinese-style rails. The findings of the report were then used to recreate the original rails on Pavilion IX as a prototype for the Lawn.¹⁴⁹

PAVILION IX

NOTES

Abbreviations used in notes

<i>Annual Report</i>	<i>Report to the President and Directors of the Literary Fund</i>
BV	Board of Visitors, University of Virginia
CD	<i>Cavalier Daily</i>
LC	Thomas Jefferson Papers, Library of Congress, American Memory Database
PL	Ledgers maintained by the Proctor of the University of Virginia, UVSC, Record Group 5/3/2.961
PP	Papers of the Proctors of the University of Virginia, UVSC, Record Group 5/3
TJ	Thomas Jefferson
TJP	Jefferson Papers of the University of Virginia, UVSC
UVSC	University of Virginia Library, Special Collections

Unless otherwise referenced, the Jefferson correspondence cited below is from the Jefferson Papers of the University of Virginia Library, Special Collections. The texts of these and many other documents relating to the University that date from 1817 to 1828 have been transcribed and are available in the Thomas Jefferson Digital Archive at the University of Virginia, Electronic Text Center (<http://etext.lib.virginia.edu/jefferson/>). In those instances where only a portion of the text appears in the transcript, the microfilm version or on-line scan of the original document was consulted. The original spellings have been maintained. The online transcriptions of the minutes of the Board of Visitors meetings were used (<http://lib.virginia.edu/digital/collections/text/biv.html/>).

The *Documentary History of the Construction of the Buildings at the University of Virginia, 1817-1828*, by Frank E. Grizzard Jr., also available at the Thomas Jefferson Digital Archive, is an invaluable guide to documents relating to the construction of the University.

1. TJ to L. W. Tazewell, 5 Jan. 1805, TJP. See Mary N. Woods, "Thomas Jefferson and the University of Virginia: Planning the Academic Village," *Journal of the Society of Architectural Historians* 44 (Oct. 1985), 282-283, for a discussion of architectural precedents for colleges and other institutional structures in the U. S. and Europe that were known to Jefferson.
2. TJ to Hugh White, May 6, 1810, LC.
3. These drawings are illustrated in Richard Guy Wilson, ed., *Thomas Jefferson's Academical Village: The Creation of an Architectural Masterpiece*, rev. ed. (Charlottesville and London: University of Virginia Press, 2009), 8-9.
4. BV, Minutes, May 5, 1817.
5. TJ to James Dinsmore, April 13, 1817.
6. Dinsmore to TJ, April 22, 1817.
7. BV, Minutes, May 5, 1817.
8. BV, May 5, 1817.
9. TJ to William Thornton, May 9, 1817.
10. Thornton to TJ, May 27, 1817.
11. Thornton to TJ, May 27, 1817. Thornton also proposed that "the two buildings next the angles be joined together, & be placed in the angles." In this letter Thornton also included advice on tinting mortar and plaster, Coade and other artificial stone, site preparations, building a fountain and a pond, exercise grounds, botanic and culinary gardens, and a "general system of Education."
12. TJ to Benjamin Henry Latrobe, June 12, 1817.
13. Latrobe to TJ, June 28, 1817, trans. LC.
14. Latrobe to TJ, June 28, 1817, LC.
15. TJ to Latrobe, Aug. 3, 1817, LC.
16. TJ to Latrobe, Aug. 3, 1817, LC. Other parts of this letter refer to the pavilions, but the writing is not legible in the online scan, and no transcription was located.

HISTORY

17. Latrobe to TJ, Aug. 12, 1817, LC.
18. TJ to Latrobe, Aug. 24, 1817, LC.
19. TJ, "Pavilion IX We. Ionic of the temple of Fortuna Virilis," TJP.
20. Latrobe to TJ, Oct. 6, 1817.
21. TJ to Latrobe, Oct. 12, 1817, LC.
22. TJ to Latrobe, May 19, 1818.
23. Latrobe to TJ, Oct. 28, 1817, LC.
24. TJ, Operations at & for the College, July 18, 1817. Frank E. Grizzard Jr., "The Documentary History of the Construction of the Buildings at the University of Virginia, 1817-1828" (PhD diss., University of Virginia, 1966), Chapter 1, p. 13, available at the Thomas Jefferson Digital Archive.
25. TJ to John Hartwell Cocke, July 19, 1817, trans., Cocke Family Papers, UVSC.
26. BV, Minutes, July 28, 1817.
27. BV, Minutes, Oct. 17, 1817.
28. The report is quoted in Grizzard, Chapter 2, pp. 5-6.
29. JG to William Short, Nov. 10, 1818, Coolidge Collection of Thomas Jefferson manuscripts, Massachusetts Historical Society.
30. TJ to Joseph Carrington Cabell, Jan. 28, 1819.
31. BV, Minutes., Feb. 26, 1819.
32. David Watson to John Hartwell Cocke, March 8, 1819, J. H. Cocke Papers, UVi; quoted in Grizzard, Chapter 2, p. 6.
33. BV, Minutes, March 29, 1819.
34. Cocke to TJ, April 17, 1819.
35. Cocke to TJ, May 3, 1819, trans. in Grizzard, Appendix E.
36. TJ to James Breckenridge, Robert B. Taylor, James Madison, and Chapman Johnson, July 8-16, 1819, trans. Grizzard, Appendix E.
37. TJ to Brockenbrough, June 5, 1819.
38. TJ to Cocke, May 3, 1819.
39. TJ to Brockenbrough, Sept. 1, 1819.
40. BV, Minutes, Oct. 4, 1819.
41. BV, *Annual Report*, Oct. 4, 1819, Dec. 1, 1819.
42. TJ to George Ticknor, Dec. 24, 1819, LC.
43. TJ to Thomas Cooper, Nov. 19, 1819.
44. TJ to Madison, Feb. 16, 1820, LC.
45. Cabell to TJ, Feb. 24, 1820, cited in Grizzard, Chapter 5, p. 2.
46. TJ to Brockenbrough, c. April 10, 1820.
47. TJ, Proposal for University Expenditures, April 10, 1820.
48. Thomas Jefferson, Study for Pavilion IX, c. March 29, 1819, N-357, TJ Papers, UVA. Thomas Jefferson, Specifications Book, July 18, 1819 [on cover], p. 17, TJ Papers, UVA.
49. Richard Guy Wilson and Sara A. Butler, *The Campus Guide: University of Virginia* (New York, Princeton Architectural Press, 1999), 39-40. William Bainter O'Neal, Jefferson's Fine Arts Library, His Selections for the University of Virginia Together with His Own Architectural Books (Charlottesville: Univ. Press of Virginia, 1976), 169-179.
50. BV, *Annual Report*, Oct. 2, 1820, pp. 5-6, 10-11, UVSC.
51. Grizzard, Chap. 6, pp. 3-4.
52. Curtis Carter and John M. Perry, Agreement, Jan. 4, 1821, PP, Box 2, Folder Jan. 4, 1821, UVSC.
53. TJ to John Vaughan, April 8, 1821.
54. TJ to BV, Sept. 30, 1821. A view of the whole expenses of the funds of the University, microfilm version, TJP. UVSC.
55. BV, *Annual Report*, , Nov. 30, 1821, pp. 3-4, 33-34.

PAVILION IX

56. BV, Minutes, Nov. 29-30, 1821. William B. O'Neal, *An Intelligent Interest in Architecture, A Bibliography of Publications about Thomas Jefferson as an Architect, together with an Iconography of the Nineteenth-Century Prints of the University of Virginia*, American Association of Architectural Bibliographers, *Papers*, Vol. 6 (1969), 75-78.
57. TJ to Cocke, April 9, 1821.
58. BV, *Annual Report*, 1822, p. 3.
59. The information on the contractors and prices in this and the following paragraphs is taken from the following sources: PL, 1819-1825, Pavilion No. 9 West, p. 46. PP, Box 17, Folder Building Accounts for Original Buildings. "Thomas Jefferson's Academical Village: The Creation of an Architectural Masterpiece," brochure listing construction workers published by the University of Virginia Art Museum, 2009. BV, *Annual Report*, Nov. 30, 1821, pp. 3-4, 33-34; *Annual Report*, 1824, p. 30. Chris Crowder, "Pavilion IX, the University of Virginia," 1988, UVSC. Grizzard, Chap. 3, p. 21; Chap. 5, pp. 3, 6-8; Chap. 6, p. 9. Calder Loth, "The Making of Oil Brick in Virginia," *Bulletin of the Association for Preservation Technology* 11, No. 3 (1979), 35-43.
60. BV, *Annual Report*, 1823, p. 4.
61. BV, *Annual Report*, 1825, p. 3.
62. Harry Clemons, *Notes on the Professors for Whom the University of Virginia Halls and Residence Houses are Named* (Charlottesville: University of Virginia Press, 1961), p. 133.
63. Ibid. Bob Brown, "George Tucker," *CD*, Sept. 28, 1956, p. 2.
64. Clemons, 134.
65. Autobiography of George Tucker, Jan.-March 1858, MSS 5427, UVSC, vol. 2, p. 1.
66. Autobiography of George Tucker, vol. 2, p. 3.
67. Clemons, 136.
68. PL, 1826-1832, pp. 128, 158.
69. BV, *Annual Report*, 1826.
70. PL, 1826-1832, p. 30.
71. BV, Minutes, July 10, 1829.
72. BV, Minutes, July 11, 1831.
73. BV, Minutes, July 10, 1832. The resolution stated that "it shall be the duty of the Proctor under the directions of the Executive Committee to cause to be erected in the rear of Professor Emmet's Pavilion an addition to the basement story for the accommodation of Domesticities similar to those already annexed to the Pavilions of Professors Tucker, Bonnycastle, and Harrison..."
74. George Tucker to ?, Aug. 1, 1832, PP, Box 8, Folder 1832 Correspondence. In this letter Tucker wrote:
- Being about to leave the University for some weeks, I should be wanting in my duty if I did not endeavor to impress on your mind the urgent necessity of getting the Dormitories and other parts of the Institution subject to your control in a state of cleanliness & repair with as little delay as possible. It seems to be now generally admitted that the Cholera will find its way to all the thickly inhabited parts of the United States – villages as well as large towns – and that its malignity can be greatly mitigated by timely precautions steadily adhered to. To neglect such precautions would seem then to be folly in the extreme. Even if we doubted the efficacy of such measures, or the probability of the approach of the disease, yet the confident belief which others have of both these facts, and the extreme anxiety which they feel when they are disregarded, make it a duty of humanity to adopt them.
- I must therefore earnestly request your attention to the following measures:
- To require the Janitor's immediate compliance with the former order respecting the privies.
- To have the dormitories whitewashed, & well scoured, using soap about all the inside woodwork. If the lime ordered cannot be counted upon in a few days, it had better be procured in the country.
- To have such cellars as have been occupied whitewashed.

HISTORY

To have the offal from the kitchens to which may be deposited rear the Pavilions & Hotels removed to a proper distance; and to ask of these several occupants to cooperate in that extraordinary attention to cleanliness in their respective premises which is now so imperiously demanded. Of the ordinary duties of preparing for the opening of the session[?], I think it unnecessary to speak—

75. BV, Minutes, July 19, 1833.
76. BV, Minutes, July 19, 1833; BV, Minutes, Aug. 17, 1837 (this work is also noted in the 1839-40 finance committee report). The minutes of July 4, 1840, directed in regard to the addition that “the Proctor refund to professors Tucker and Cabell without Interest the sums which are or shall be severally advanced by them for the improvements and additions heretofore authorised to be made in the pavilions respectively occupied by them... in all cases where glass has been broken and still calls for renewal in the windows of the pavilions, that the proctor cause the glass to be replaced as soon as practicable, at the expense of the respective professors.” In the Board of Visitors Minutes of July 1, 1841, is a resolution stating “that the Proctor be authorised [sic] to pay to Professor Tucker the Interest upon the money advanced by him under the authority of the resolutions of July 1829 & 1837 for certain alterations in pavilion N^o.9 as the same was stipulated in said resolutions, from the time of it’s [sic] expenditure until it was reimbursed.” Damage to Dor &c, n.d., PP, Box 16, Folder ND. Letters and Receipts.
77. Tripp Evans, “Pavilion IX,” *The Cavalier Daily*, Nov. 21, 1988. The article stated that the addition was done during McGuffey’s occupancy, but that dating appears to be incorrect.
78. Clemons, 135. Autobiography of George Tucker, vol. 2, p. 15.
79. BV, Minutes, July 1, 1845.
80. Autobiography of George Tucker, vol. 2, p. 16.
81. Clemons, 136. *The First Professors*, p. 97.
82. BV, *Annual Report*, 1848, p. 15.
83. Pendleton Hogan, *The Lawn: A Guide to Jefferson’s University* (Charlottesville, University of Virginia Press, 1987), 29.
84. BV, *Annual Report*, 1849, p. 65; 1853-4, p. 11.
85. BV, *Annual Report*, 1854, p. 9.
86. BV, *Annual Report*, 1855, pp. 37–38.
87. BV, Minutes, June 25, 1855.
88. Ibid.
89. BV, *Annual Report*, 1856, p. 9.
90. BV, *Annual Report*, 1857, p. 46.
91. BV, Minutes, Sept. 1, 1858.
92. BA, Repairs and Improvements, pp. 52, 53, 212.
93. BA, Repairs and Improvements, p. 107.
94. PL, 1861-1865, p. 492, 525; 1866-1867, p. 528.
95. BV, Minutes, July 5, 1865.
96. PL, 1866-1867, p. 678; 1868-1870, p. 170, 665; 1870-1871, p. 674; 1871-1872, p. 634; 1872-1873, p. 518.
97. Clemons, 90. BV, *Annual Report*, Sept. 18, 1873.
98. Clemons, 93. “Historic Tree Still Survives,” *CD*, May 1, 1975. Richard Guy Wilson, ed., *Thomas Jefferson’s Academical Village: The Creation of an Architectural Masterpiece*, rev. ed. (Charlottesville and London: University of Virginia Press, 2009), 96.
99. “Pavilion IX,” *CD*, Nov. 21, 1988, p. 5. BV, *Annual Report*, 1877, p. 26.
100. BV, Minutes, June 25, 1873. The minutes reported that “Pavilion No. 9 heretofore occupied by Prof. McGuffey, be assigned to Professor Venable, and the Pavilion now occupied by Professor Venable be assigned to Professor Peters, with authority to the said Professors to make such different allotment from the foregoing, of the said Pavilions, between them, as they may agree

PAVILION IX

upon...The usage which seems to have prevailed at the University for many years would seem to be justification sufficient for the recommendation that Yr. committee makes that the McGuffey pavilion be assigned Prof. Venable. This usage together with the reasons assigned by Prof. Venable in his communication upon this subject to the Board, and a like Communication of Prof. Peters herewith filed as an Exhibit (A) waiving his application heretofore made, have removed all difficulties out of the way of the Comt^{ce} and they therefore approve the application of Prof. Venable that the McGuffey Pavilion be assigned him; that the one heretofore used by Prof. Venable be placed at the disposal of Prof. Peters; with the proviso that Prof. Venable and Peters may make any other disposal of these two pavilions among themselves that may be mutually satisfactory.” BV, Minutes, June 26, 1876, stated that “Your Committee recommend that the request of Prof. Venable that he be put on the Commutation list and no pavilion be assigned him be granted.” (Venable moves to a pavilion on the East Lawn on May 4, 1886.) The list of building residents can be found at <http://www.virginia.edu/100yearsawn/>.

101. Clemons, 115–117. *CD*, Oct. 27, 1956. Barringer, pp. 3–4. As a regiment commander during the Confederate invasion of Pennsylvania, Peters was ordered to burn Chambersburg, but he refused. This refusal was met with approval by Gen. Robert E. Lee, and Peters was never court-martialed for his disobedience.

102. Clemons, 115–117. BV, Minutes, Mar. 2, 1899, stated that “Whereas Col. Wm. E. Peters has informed the Board of Visitors that he intends to resign his Professorship of Latin in the University of Virginia to take effect June 1902, and Whereas, with this knowledge, the Board should take steps to have his work continued in worthy hands, and Whereas Prof. Thos. Fitzhugh of the Chair of Latin in the University of Texas has expressed his willingness to accept a professorship of Latin in the Univ. of Va. on condition that he be given a three years leave of absence without pay, subject however to recall by the Board at their pleasure, and will spend two of these years studying at the University of Berlin, Germany and one in travel and research in classic lands. Therefore be it Resolved: That Prof. Thos. Fitzhugh be

and is hereby elected a Professor of Latin in the University of Va. on the conditions and with the understanding stated above.” BV, Minutes, Nov. 20, 1901, stated that “Whereas, Col. W^m E. Peters active professorship will terminate in June next, Be it Resolved that he be allowed to continue his occupancy of the pavilion now assigned him until Nov. 1st, 1902, without charge...Resolved: That the Board responding to the request of the Faculty as contained in paragraph VI. of their report now before the Board, for the purpose of settling the question of official seniority of Prof. Fitzhugh under the resolution of this Board of March 3rd, 1899, hereby determines that Prof. Fitzhugh shall be considered as becoming a professor in June, 1902, or at any time prior thereto should he qualify as active professor of Latin under the aforesaid resolution of March 3rd, 1899.” BV, Minutes, June 17, 1902, stated that “the disposition of the pavilion now occupied by Col. Peters be postponed until the October meeting of the Board.” BV, Minutes, Oct. 17, 1902, stated that “On the application of Professor Thomas Fitzhugh, the applications of Professors Buckmaster & Wilson having been withdrawn, it is ordered that the Proctor assign to Professor Thomas Fitzhugh, as a residence, the Pavilion formerly assigned to Professor Peters, to take effect when Col. Peters is able to move to his own house, now being repaired.”

103. BV, Minutes, June 29, 1874. Chris Crowder, “Pavilion IX, the University of Virginia: Charlottesville, Albemarle County,” p. 3, SVA no.93 1988, UVSC. BV, *Annual Report*, 1877, p. 26.

104. BV, *Annual Report*, 1874, p. 4.

105. BV, *Annual Report*, 1875, p. 4.

106. BV, *Annual Report*, 1875, p. 6; 1877, p. 26.

107. PL 1874-1875, p. 444; 1877-1878, p. 436.

108. PL, 1878-1879, p. 434.

109. PL, 1877-1878, p. 436; 1879-1893.

110. BV, *Annual Report*, 1878, p. 20.

111. BV, *Annual Report*, 1879, p. 3.

112. BV, *Annual Report*, 1881-82, p. 4.

HISTORY

113. Ernest W. Bowditch, "Recent Sanitary Work at the University of Virginia," *Journal of the Association of Engineering Societies* vol. IV, no. 8 (June 1885): 325.
114. BV, *Annual Report*, 1883-84, p. 3.
115. BV, *Annual Report*, 1883-84, p. 5.
116. BV, *Annual Report*, 1884-85, pp. 3-4.
117. BV, *Annual Report*, 1884-85, pp. 3-4.
118. BV, Minutes, June 26, 1884, stated "that the Proctor be directed to have repairs to pavilion, No 9, recommended in Faculty Report, done by hiring workmen by the day and furnishing material for same."
119. BV, *Annual Report*, 1884-85, p. 17. PL, 1884-1885, p. 535. Payments were made as follows for the porch:
- | | | |
|---------|------------------|-------|
| Aug. 12 | To G. S. Ford | 17.87 |
| | To J. B. Hawkins | 6. |
| | " G. S. Ford | 40.25 |
| | " Karn & Hickson | 80.06 |
| | " G. S. Ford | 17.80 |
| 29 | " J. J. Montague | 4.25 |
| 30 | " G. S. Ford | 4.87 |
| | " J. J. Montague | 2.25 |
| Sept. 1 | To J. Bishop | 7.28 |
| 6 | " G. S. Ford | 5.82 |
| 13 | " " " | 5.50 |
| Nov. 30 | To G. S. Ford | 7.41 |
120. PL, 1873-1874, p. 434; 1874-1875, p. 444; 1875-1876, p. 442, 524; 1877-1878, p. 436; 1878-1879, p. 434; 1879-1883.
121. PL, 1888-89.
122. BV, *Annual Report*, 1887-88, p. 12.
123. BV, *Annual Report*, 1887-88, p. 11.
124. BV, *Annual Report*, 1889-90, p. 3. The two pavilions were not identified.
125. BV, *Annual Report*, 1890-91, pp. 9, 14; 1891-92, pp. 13, 22.
126. BV, Minutes, June 12, 1905.
127. BV, Minutes, June 12, 1905, included this information from the report of Thomas H. Carter, proctor: "Granolithic Walks North of Rotunda, 1024 yards, can be finished at \$1.00 a yard. I recommend that it be done at once, both for economy and for appearance. Afterwards the walks South of the Rotunda, extending from residence of Prof. Lile on East Lawn, around the Quadrangle to the residence of Prof. Fitz-Hugh on West Lawn, about 1320 yards, should follow. The walks were begun in 1895, two years before I entered upon my duties here, and were laid around the Lawn, only to Prof. Lile's and to Prof. Fitz-Hugh's, and Ranges, and from the Rotunda to the Post-Office. They should be continued to Monroe Hill and Dawson's Row, and to the Hospital, and elsewhere, regularly, until fully completed."
128. Barringer, p. 19.
129. Obituaries, *University of Virginia Alumni News* 45, no. 5 (March 1957): 23.
130. BV, Minutes, Apr. 30, 1929, included a resolution stating that "Pavilion IX, when vacated by Professor Thomas Fitzhugh, be assigned to Professor J. L. Newcomb, at an annual rental of \$ 500."
131. *University of Virginia Alumni News* 42, no. 4 (Feb. 1954): 22.
132. CD, Feb. 24, 1954.
133. "Dr. John Lloyd Newcomb, 1881-1954," *University of Virginia Alumni News* 45, no. 5 (March 1957): 23.
134. *College Topics*, Feb. 17, 1939.
135. CD, June 9, 1966.
136. BV, Minutes, Jan. 9, 1953. The Report of the Buildings and Grounds Committee "prepared the following recommendations regarding the assignment of Pavilions
1. That a policy be established providing representation on the Lawn from each of the six schools: College and Graduate Studies, Law, Medicine, Engineering, Education, and Business Administration. A precedent for

PAVILION IX

this policy was established by the original assignment of Pavilions on the Lawn to Professors who were heads of the several schools.

2. Only full professors to be eligible, that deans be given preferential [sic] consideration, and that seniority shall be given consideration along with other factors.

3. That the College, being larger than the other schools, be assigned two additional Pavilions.

4. That Professor J. W. Beams, being a representative of the College and also qualifying in order of seniority, be assigned to Pavilion III, known as the Graduate House.

5. That Pavilion VI, known as the Romance Pavilion, and Pavilion II, soon to be vacated by Dean Ivey Lewis, be reserved for schools not now represented on the Lawn.

6. That no Pavilion be designated for any particular school.”

137. BV, Minutes, June 10, 1960, states that “the Buildings and Grounds Committee, at its meeting on 9 June 1960, had considered at length the present policy of the Board of Visitors with respect to the assignment of pavilions, hotels, and residences on the Grounds to members of the faculty. The Committee had noted that the present policy was established by the Board in 1953 (Minutes, Board of Visitors, University of Virginia, No. 11, 9 January 1953, page 274) and that a number of schools had been established since that time along with the position of Chancellor for Community Colleges. Accordingly, the Buildings and Grounds Committee proposed, and the Board adopted the following resolution

RESOLVED by the Board of Visitors of The Rector and Visitors of the University of Virginia that the Buildings and Grounds Committee of this Board, in its assignment of pavilions, hotels, and residences to members of the faculty, shall be governed by the following policy

That housing upon the Lawn, the Ranges, Monroe Hill, and the Dawson’s Row area, as available in the future for assignment to

members of the faculty, be assigned upon the following basis

(a) The Deans of each school (excepting Deans who are not full professors) and the Chancellor for Community Colleges shall have first priority according to the seniority of their respective schools or office.

(b) Subject to (a), full professors shall have priority, irrespective of their school, in accordance with their seniority as full professors.

(c) Part-time professors shall not qualify for assignment under (b).

Professors having less than five years tenure before retirement or professors without families shall not qualify for assignment under (b).”

138. “‘All the Hoos in Hooville’: Fabled Faculty,” <http://www2.lib.virginia.edu/exhibits/hoos/fabled.html>. See <http://etext.virginia.edu/bsuva/officers.html>.

139. Crowder, p. 8.

140. BGC, Minutes, Sept. 28, 1962, p. 2.

141. Crowder, p. 8.

142. *CD*, Nov. 21, 1988, p. 5.

143. “Arts, Sciences Dean to Resume Teaching,” *Progress*, Sept. 18, 1984, A1.

144. *CD*, Nov. 21, 1988, p. 5.

145. See <http://www.arch.virginia.edu/faculty/visiting/porter/>; <http://www.virginia.edu/architectoffice/memorialtree/officialPorter.html>; <http://www.virginia.edu/uvatoday/newsRelease.php?print=1&cid+13945>.

146. See <http://www.arch.virginia.edu/faculty/WilliamAMcDonough>; <http://mcdonough-partners.com/about>; <http://www.mcdonough.com/bio.htm>; accessed June 23, 2011.

147. See <http://wdpa.com/failure-investigation-litigation-support-projects.html>, accessed June 23, 2011.

HISTORY

148. "At Home With--Karen Van Lengen," *New York Times*, Sept. 6, 2001.

149. Mesick-Cohen-Wilson-Baker, "Chinese Rail Investigation," October 2007, Office of the Architect for the University of Virginia; Mesick-Cohen-Wilson-Baker, "Chinese Rail & Colonnade Roof Restoration," August 15, 2007, drawing set #094514, Facilities Planning and Construction Department Resource Center Library, University of Virginia.

PAVILION IX

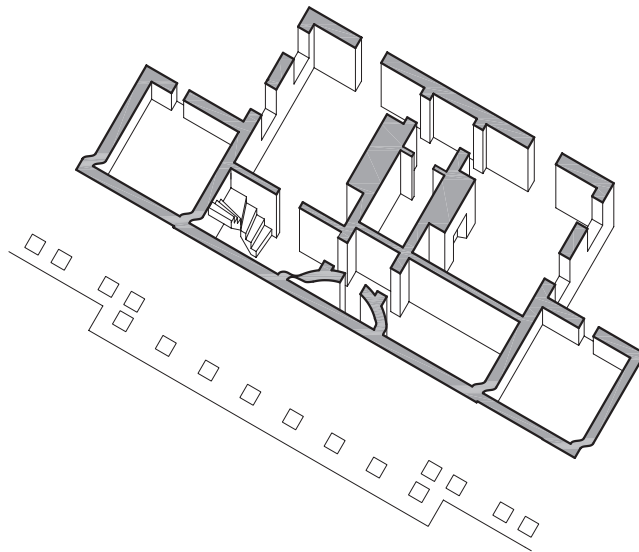
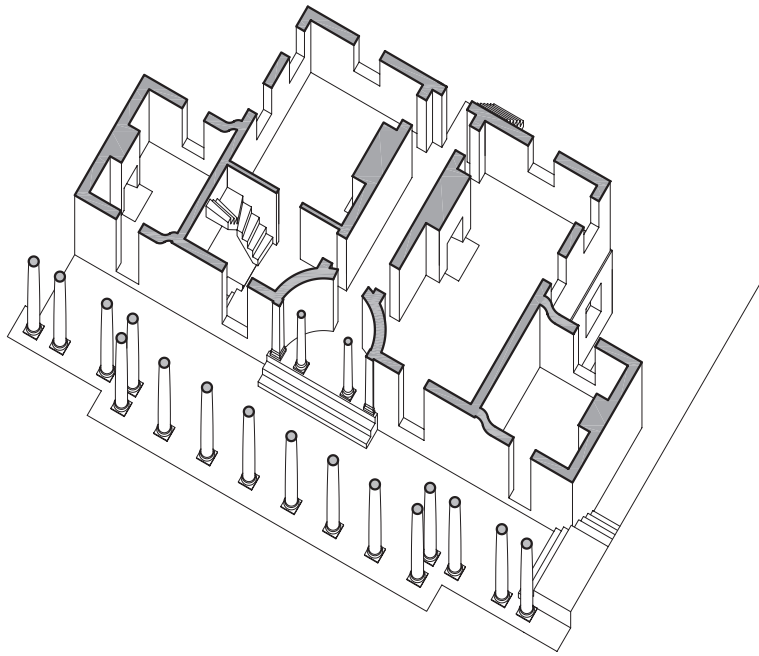

HISTORY

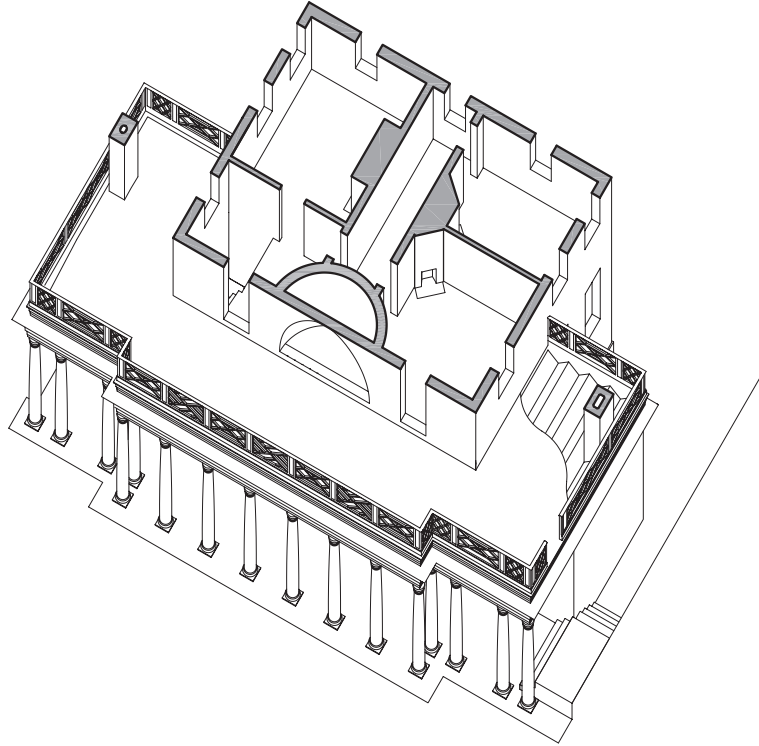

CIRCA 1822

Bottom left, basement after completion of the pavilion in 1822. The large room was used as the kitchen. The central hall included a closet or pantry.

Top left, first floor after completion of the pavilion. The large room was used as a lecture space.

Above, second floor after completion of the pavilion. This floor included the large parlor and two private chambers for the professor.

PAVILION IX

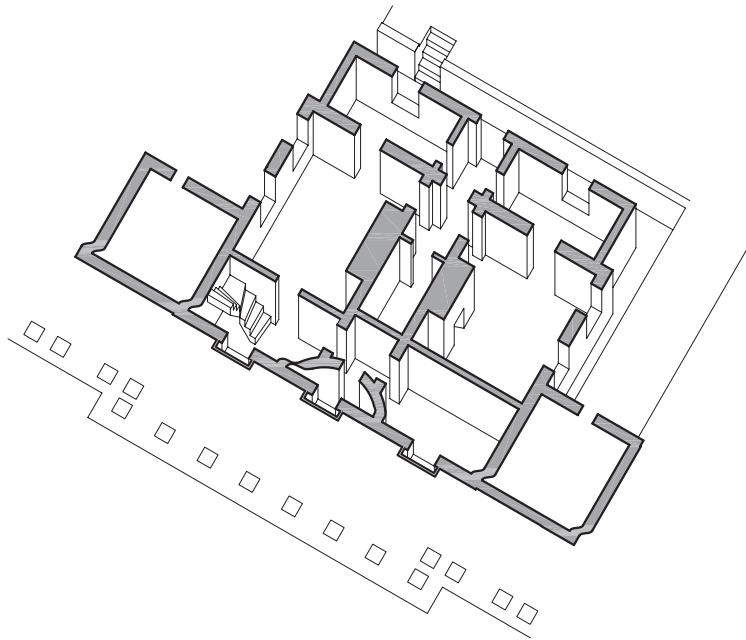
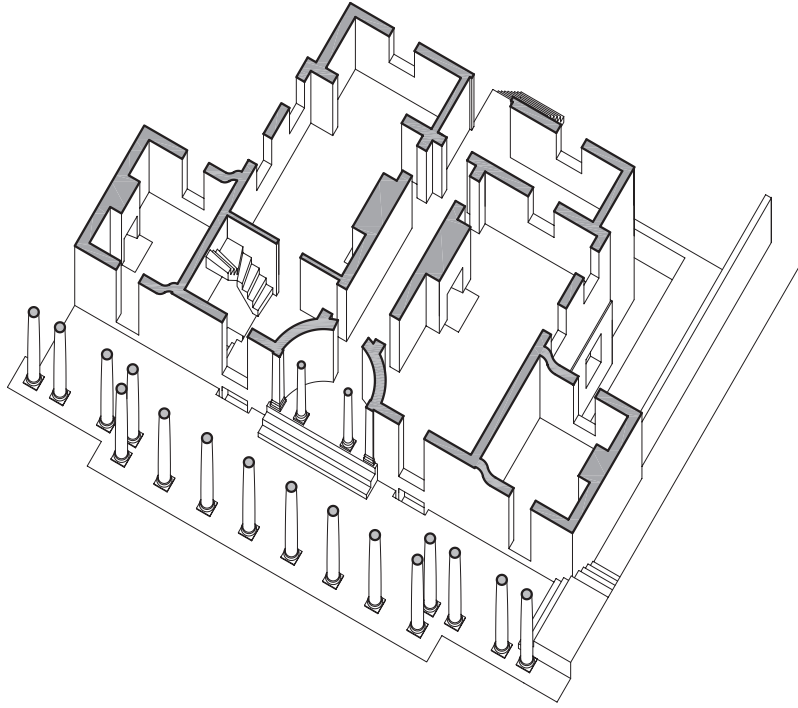

HISTORY

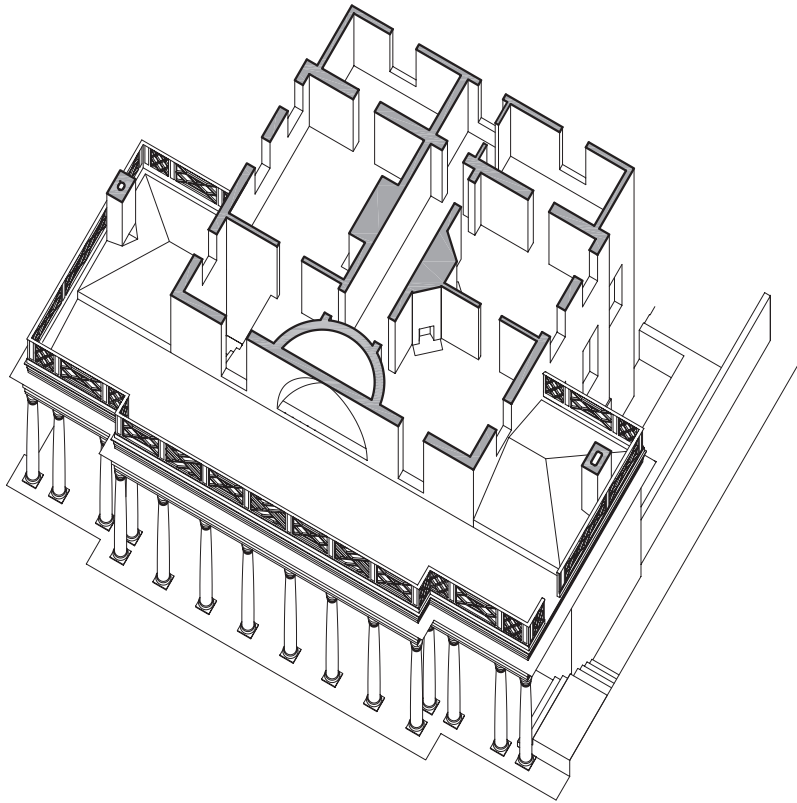

AFTER CIRCA 1831

Bottom left, basement after completion of the circa 1831 west addition.

Top left, first floor after completion of the west addition. There was no door in the west doorway; the north end of the addition appears to have been an exterior space.

Above, second floor after completion of the west addition. A door was inserted in the partition between the two north bedchambers.

PAVILION IX

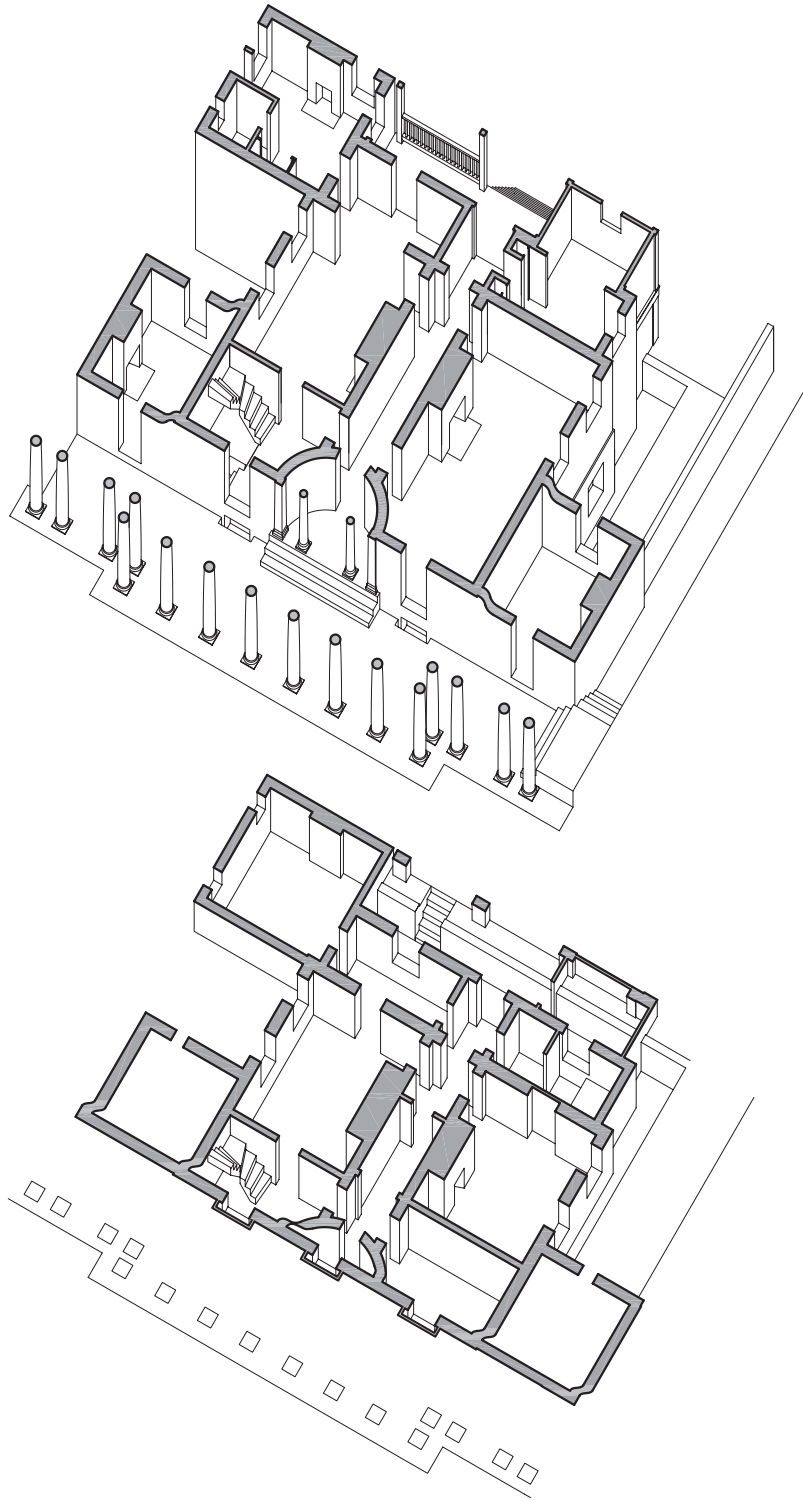

HISTORY

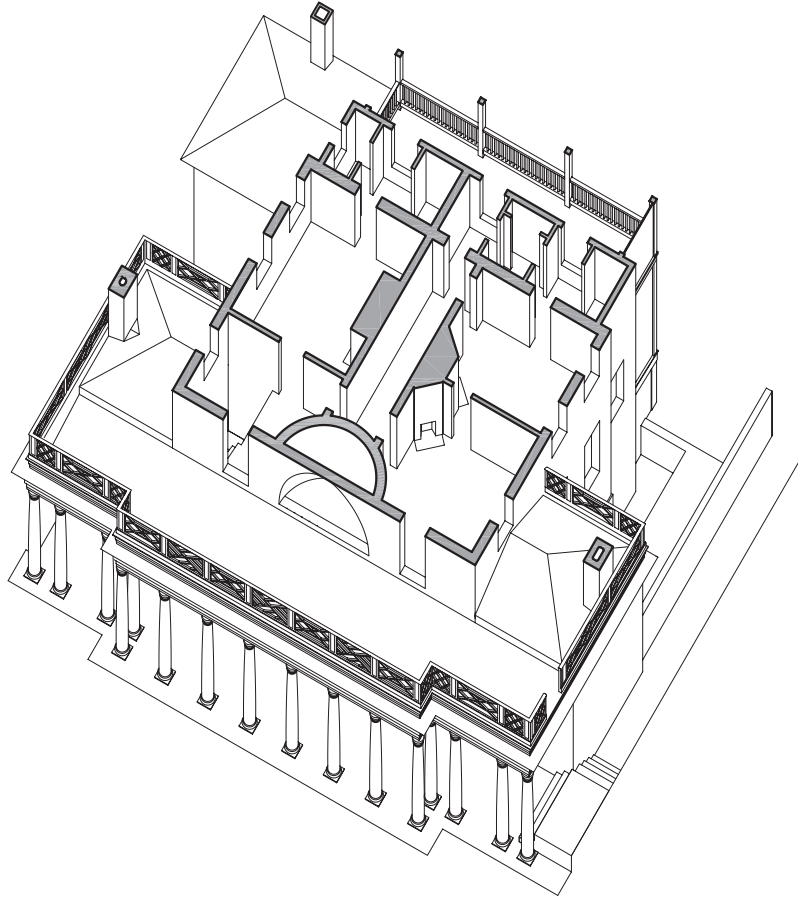

2010

Bottom left, basement in 2010. A three-level porch on the west facade was built in 1856-1891. A room was built onto the southwest corner of the structure in 1896-1900.

Top left, first floor in 2010. Between 1963-1978, the kitchen was expanded to include the north end of the west porch.

Above, second floor in 2010. At some point in the twentieth century, the door between the north bedchambers was moved to the south.

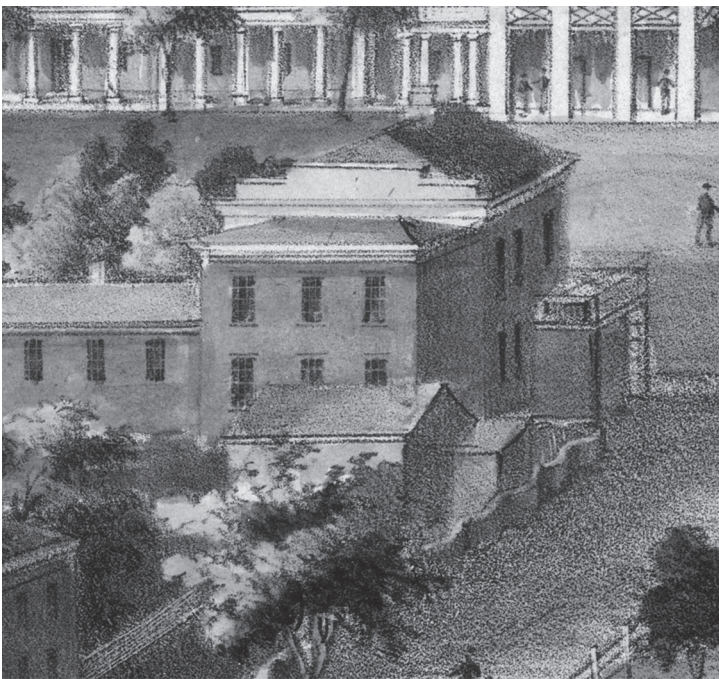
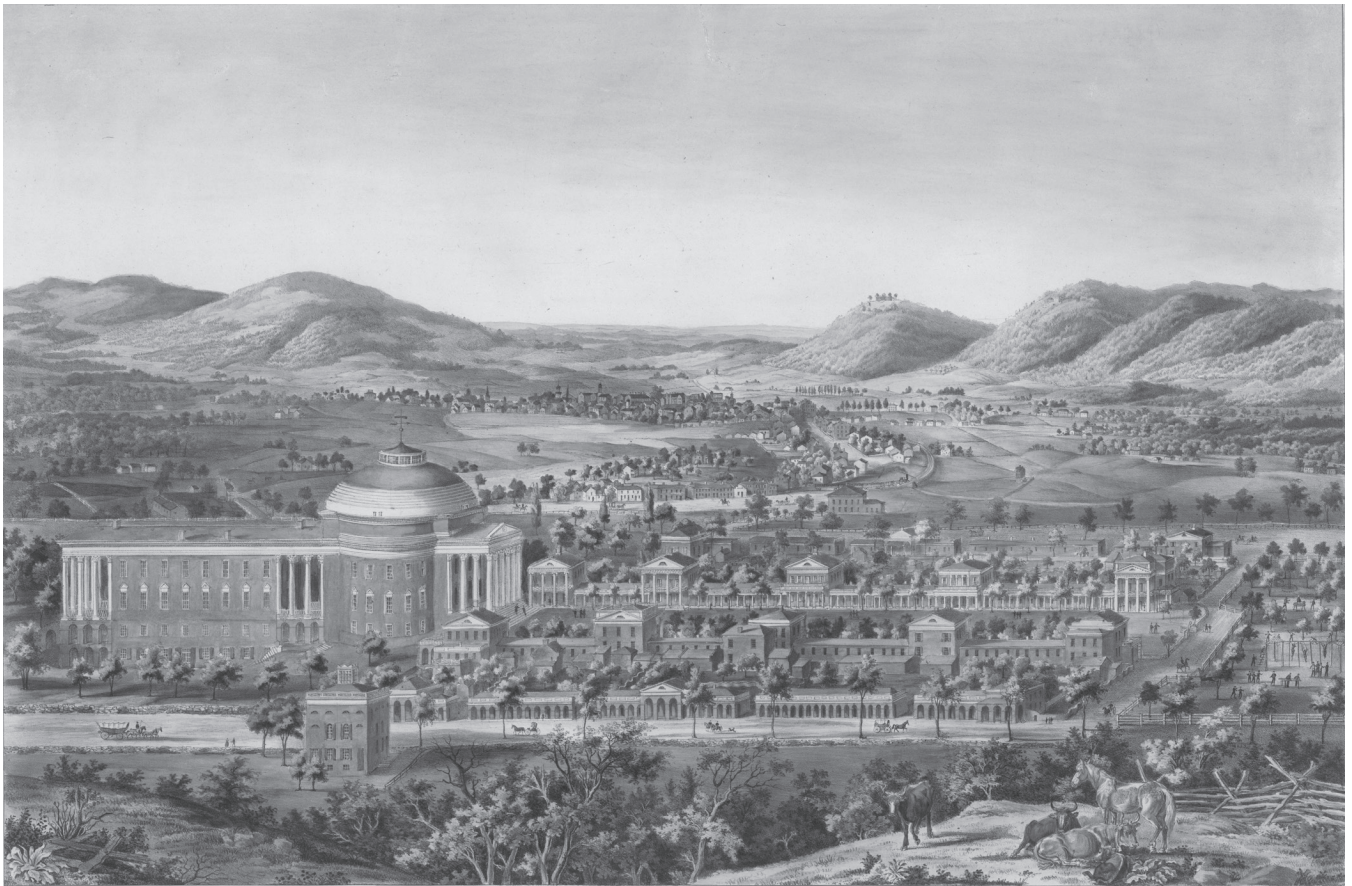

View of the University of Virginia, Charlottesville & Monticello, Taken from Lewis Mountain, Charlottesville, Virginia (by Casimir Bohn, 1856); the rear addition (as seen in the detail to the left) has been constructed

PAVILION IX

ARCHITECTURAL DESCRIPTION

The architectural investigation of Pavilion IX by a team of architects and historians began in December 2009 and continued through June of 2010. At the beginning of the investigation, the pavilion was occupied and fully furnished, making an in-depth inspection difficult. The pavilion was vacated in March 2010; during the final visits it was possible to inspect the interior in greater detail and to carry out selective probes into the architectural fabric to help answer questions about the construction and evolution of the building.

As part of the analysis and recording of the pavilion, the architects produced a full set of record drawings, including floor plans of the basement, first floor, second floor, and attic as well as a roof plan, full elevations, and building sections. The team also prepared detail drawings of selected doors, mantels, and moldings.

At the same time, a separate finishes investigation and analysis was undertaken by Mark Kutney, Conservator for the Office of the Architect for the University of Virginia. The results of this investigation are included with the exterior and interior descriptions. The Kutney report refers to the various color finishes by name, and some are matched to the Munsell Color system. Only those finishes with Munsell numbers are included in this report. The color descriptions included in brackets correlate to the descriptions used in the historic structure reports for Pavilions I, II, V, and VI.

VISUAL SOURCES

The plan and exterior appearance of Pavilion IX can be documented by a handful of nineteenth-century visual sources. The earliest surviving documentation includes three architectural drawings. In the earliest drawing, dated 1819, Jefferson drew the front (east) elevation and plans of the basement, first and second floors. His simple drawings illustrate

PAVILION IX

the pavilion much as it was completed in 1822. The 1821 plan by John Neilson seems to record the first floor plan exactly as constructed and shows the stairway as it currently exists. The changes made during construction are noted in the exterior description of this report.

The third early drawing was produced by John Neilson in February 1823, and records the south elevation of the pavilion, the terrace, and the student room. This rendered drawing is more accomplished than the Jefferson drawing and includes tinted washes and shadows that bring the building to life. It is part of a much larger drawing that includes the Rotunda and Pavilion X.

The Jefferson drawing and the Neilson rendering record a parapet along the edge of the roof. The parapet, an important original feature of the pavilion, was removed sometime in the later nineteenth century. In the series of engravings and lithographs that record Pavilion IX and the Lawn from 1831 (as seen in William Goodacre's engraving) to 1856 (in the Sachse-Bohn lithograph), the parapet is clearly recorded. By the time that the pavilion is first photographed in the late nineteenth century, the parapet is missing and the "Chinese" balustrade along the terrace has been replaced by a cast-iron railing.

Together with site maps, the early photographs record the additions to the rear of the Jefferson pavilion, including Tucker's extension in 1831, the three-level rear porch in the late nineteenth century, and the 1896-1900 southwest addition. The early photographs provide the best illustrations of important exterior features such as the louvered blinds, particularly the large, semicircular blind that was positioned in the upper portion of the entrance niche. They also show the split blinds at the two large second-floor windows flanking the niche.

No early photographs of the interior of Pavilion IX are known to exist, and there are apparently no written descriptions that would help bring to life the information gathered by this physical investigation.

EXTERIOR

Pavilion IX is located at the south end of the west side of the Lawn. The east facade facing the Lawn is three bays wide; the original pavilion is three bays deep and two stories tall above a basement. The hipped roof rises to a central chimney. A circa 1831, three-level, brick addition extends across the west facade. Later in the nineteenth century, a shallow, three-level porch was constructed along the west addition. A one-story (with basement) room was added onto the southwest corner of the building in 1896-1900.

Original single one-story student rooms flank the pavilion to form a structure that is symmetrical as seen from the Lawn, and separate from the rest of the West Lawn, connected only by the colonnade and terrace.

ARCHITECTURAL DESCRIPTION



Pavilion IX from the southeast



Pavilion IX from the east

PAVILION IX



Colonnade looking south



Semicircular entrance niche to Pavilion IX

The colonnade spans across a remarkably simple facade, dominated by a striking recessed, semicircular entrance bay (exedra) crowned with a half-dome. Jefferson's design of the east facade may have been inspired by Benjamin Henry Latrobe (Jefferson inscribed "Latrobe" on his drawing for Pavilion IX), as well as by the 1770 Hotel de Guimard in Paris designed by Claude-Nicholas Ledoux. Jefferson specified that the deep entablature at the top of the pavilion should adapt "the Ionic with dentils from the temple of Fortuna Virilis of Palladio."

The 1' 10½" high wood entablature at the top of the pavilion walls includes a three-fascia architrave (three fasciae, a cyma reversa, and a fillet) and a frieze. The cornice above the frieze begins with a bed molding (cyma reversa, a dentil band, a series of small fillets, and an ovolo) and culminates in the cymatium (projecting frieze, cavetto, and shallow cyma recta.)

Originally, there was a simple, low wood parapet above the entablature, as shown on Jefferson's elevation drawing and other early illustrations. By the time that the pavilion was first photographed, the parapet had been removed.

ARCHITECTURAL DESCRIPTION



East terrace, looking north

Early 1980s slate shingles cover the hipped roof, extending down to painted terne-coated steel sheet metal at the eaves and a built-up gutter made up of a 2x4 set on edge. At the center of the roof is a broad brick chimney breast that rises seventeen courses above the roof ridge, culminating in a three-course corbelled cap.

Colonnade and Terrace: The original colonnade projects 2' 10" forward as it passes in front of the pavilion. Columns with cut stone Tuscan bases and capitals, and stuccoed brick shafts of exaggerated entasis, support a 2' 3 $\frac{3}{4}$ " high wood entablature (two-fascia architrave, plain frieze, and cornice). Above the entablature, a two-fascia molding supports wood "Chinese" rails, installed in 2007, the latest of a series of railings along the colonnade's terrace roof: Jefferson's original "Chinese"-style railings were replaced later in the nineteenth century by a Gothic Revival, cast-iron balustrade, which in turn was replaced in 1976 with wood railings based on historic images. The 2007 railing, based on Jefferson's original railings, was the prototype for a full restoration of the Lawn's "Chinese" rails.

PAVILION IX

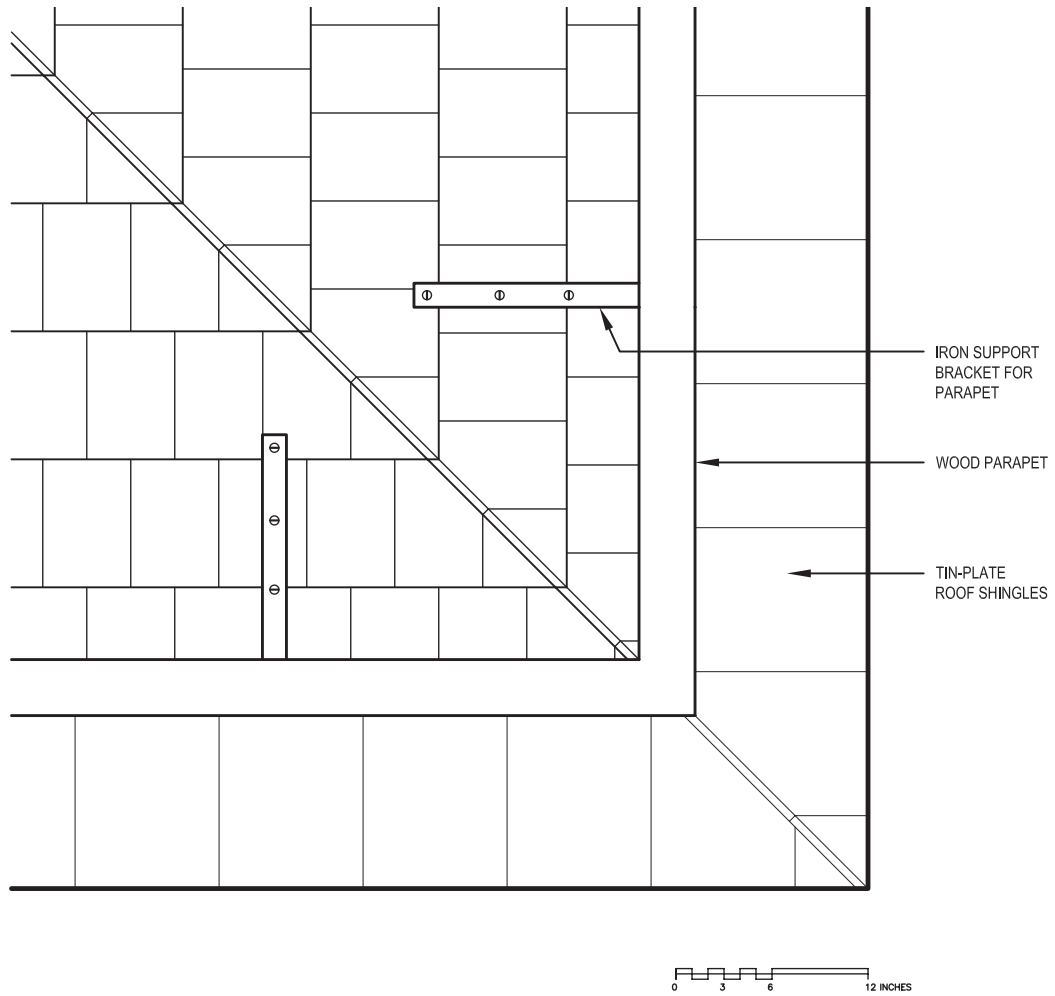

Corner of original roof surface, showing position of parapet

ARCHITECTURAL DESCRIPTION

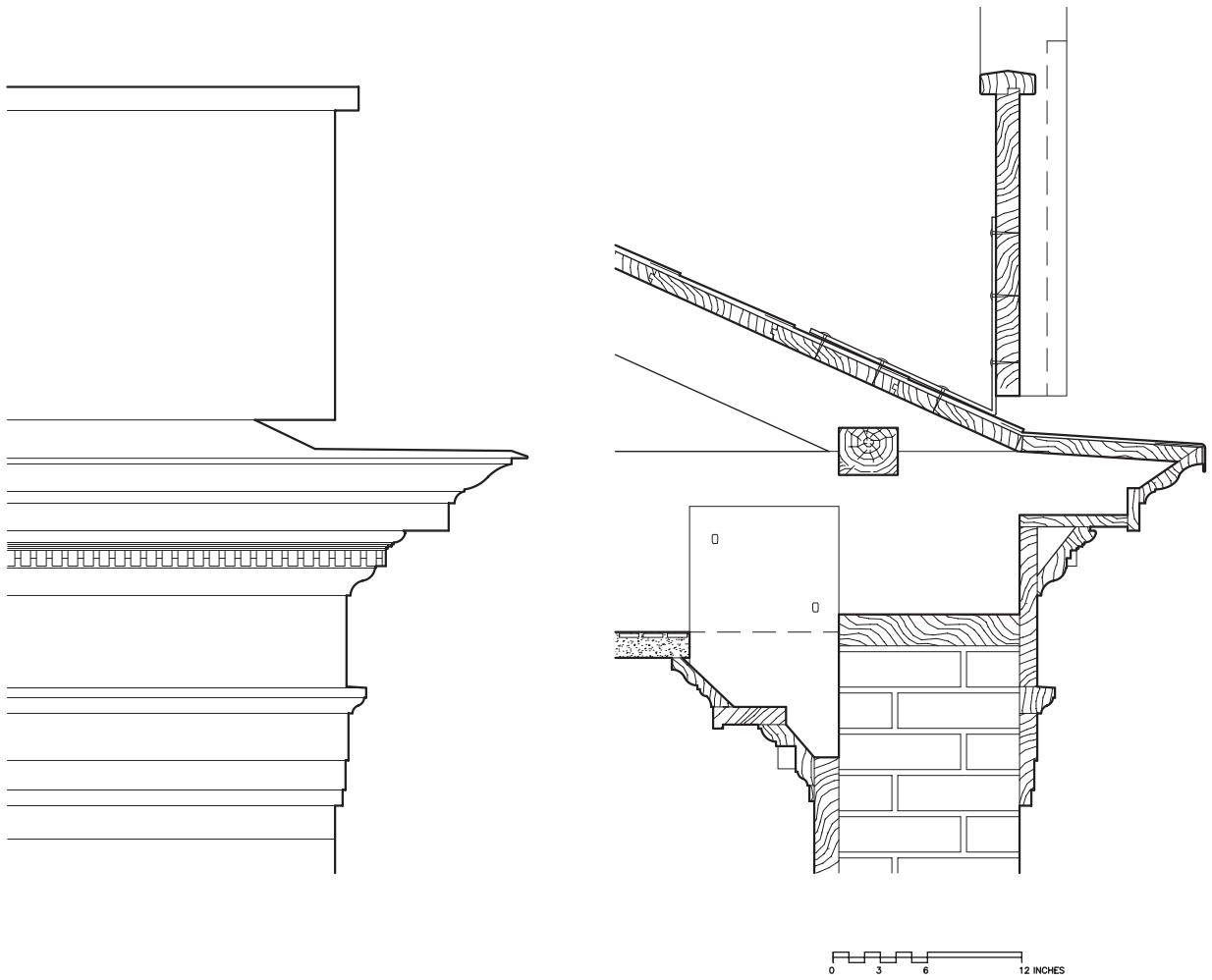

*Left, detail from south elevation showing original entablature
and restored parapet
Right, section showing location of parapet*



The Temple of Fortuna Virilis, from Book 4, Plate XXXII, from Giacomo Leoni, The Architecture of A. Palladio (London: 1721)

ARCHITECTURAL DESCRIPTION



Column capitals and entablature of recessed east entrance

The exposed structure supporting the floor of the terrace is made up of $3\frac{3}{4}$ " by $6\frac{1}{2}$ " wood beams with chamfered edges (approximately 2' 7" o.c.) spanning from the top of the colonnade entablature to the brick facade. Small sleepers, also chamfered on the bottom edges, arranged perpendicular to the beams, provide the direct support for the floorboards above. An electrical lighting fixture with a prismatic glass shade is mounted to one of the sleepers.

The terrace slopes slightly to the east for drainage, and is covered with interlocking rubber pavers, installed in 2007 over a rubber membrane. Investigations in 2007 for evidence of the original "Chinese" rail also uncovered remnants of the original serrated roofs on the student rooms, and what may be evidence for a deck above the roofs. Beneath the existing hipped roof of the south student room, stucco covers the south facade of the pavilion, and traces of a stucco band, the same height as the roof ridge, remain on the north and south facades above the roofline of the student rooms. It is possible that these stucco bands were part of an elementary flashing system when the terrace included these roofs.

PAVILION IX

ORIGINAL PAVILION: EAST FACADE

The east facade facing the Lawn is three bays wide and two stories high. The original handmade red brick is laid in Flemish bond with king closers at the window openings and queen closers at the outer edges of the facade. The handmade, smooth-faced, oil-stock bricks vary in size (7 $\frac{7}{8}$ " to 8" long by 3 $\frac{1}{2}$ " to 3 $\frac{3}{8}$ " wide by 2 $\frac{5}{8}$ " to 2 $\frac{3}{4}$ " high). These bricks were more expensive than the common bricks used for the side and rear elevations. The bricks are laid so that the height of ten courses, including joints, is approximately 2' 5 $\frac{1}{2}$ ". The mortar in the narrow joints is tooled and scribed (a narrow tool was used to inscribe a line along the center of the joint).

The pavement between the colonnade and the east facade is twentieth-century brick laid without mortar in a herringbone pattern with a two-brick-wide border parallel to the facade. The pavers are laid in a herringbone pattern between the columns of the colonnade. A six-brick-wide border extends along the outer edge of the colonnade.

Entrance: Three wood steps lead to the floor of the exedra. The lowest riser is 6"; the upper two risers are 8" high. The bullnosed treads, approximately 1' 1 $\frac{3}{4}$ " deep, are trimmed with cavetto moldings. Mesh ventilation panels, set in the risers, provide air and minimal light to the basement window beneath the steps. The wood floor is made up of 4 $\frac{1}{2}$ " to 6" wide tongue-and-groove floorboards, laid east-west.

Original, engaged, tapered wood pilasters at the edge of the opening and two original wood columns culminate in carved wood Ionic capitals supplied by Peter Sturtevant, a Richmond wood carver. The columns support a 1' 9 $\frac{1}{2}$ " high wood entablature that extends across the opening and continues around the curved niche. The entablature, whose proportions do appear to follow Palladio's drawing of the temple of Fortuna Virilis, includes a two fascia architrave (fascia, bead, fascia, cyma reversa, fillet) and a plain frieze below a denticulated crown molding (cyma reversa, fillet, projecting fascia, ovolo, fillet, projecting fascia, cyma reversa, fillet, cyma recta). The back west face of the entablature includes two nineteenth-century iron hooks driven into the surface of the frieze, 4' 8" and 4' 10" from the ends of the lintel; their function is not known. A 1' 5 $\frac{1}{2}$ " wide two-fascia wood architrave frames the second-story, semicircular opening of the half-dome. Various early photographs show a semicircular, four-panel, louvered blind in this opening. A simple iron rail was installed across the opening in 2007.

An original 8 $\frac{1}{2}$ " high wood baseboard trims the curved, stuccoed brick wall of the exedra. At the center of the niche is the original curved entrance with its 7 $\frac{1}{2}$ " wide two-fascia architrave (Type T-1) that terminates on plain, splashboard-height plinths. The original pair of entrance doors (D-1), each with three raised panels, is curved to fit in the doorway.

ARCHITECTURAL DESCRIPTION



Early wrought-iron "J"-type shutter holdback



Later cast-iron "disk"-type shutter holdback

Windows: In each of the three bays there is an early, but not original, basement window, partially below grade, facing a small well; the center opening is hidden beneath the entrance steps. The windows are framed by 6" wide two-fascia architraves and have six-light awning sash. In the north and south openings, each awning sash is made up of two separate horizontal sash; when first installed, the lower sash was operable and the upper sash fixed. Horizontal iron bars extending across the openings are old, but may not be original. The north and south window wells are protected by twentieth-century sloped wood frames filled with $\frac{1}{2}$ " hardware cloth.

The two tall, original windows on the first floor have 6 $\frac{1}{2}$ " wide two-fascia architraves (Type T-4) and 2 $\frac{3}{4}$ " thick wood sills at the bottom. They are fitted with original 6/6/6 triple-hung sash. Paired blinds, each composed of two leaves with louvered panels, flank the windows. Each leaf is supported by a pair of 1' 3 $\frac{1}{2}$ " long, wrought-iron strap hinges on pintles that are each attached to the face of the architrave by three screws. Iron slide-bolts that vary from 1' 0" to 1' 3" long fasten the louvered panels together. The blinds are held open with wrought-iron "J"-shaped holdbacks; the upper leaves are held open by later cast-iron "disk"-type holdbacks. Original wood "Chinese" railings extend across the lower sash in each opening.

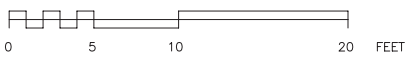



Top left, east elevation
Bottom left, section through colonnade looking towards east elevation
Top, east elevation with parapet

PAVILION IX



Pavilion IX from the north

At the second story level the two original window openings in the outer bays have 6½" wide two-fascia architraves (Type T-4), 2¾" thick sills, and original 6/6/6 sash that open directly onto the porch. Jefferson's 1819 floor plan shows a window in the center bay, but the half-dome above the entrance does not allow for an opening in that location. The twentieth-century, three-panel louvered blinds on either side of the windows are hung on pairs of wrought-iron strap hinges and held open with wrought-iron "J"-shaped holdbacks. Early twentieth-century photographs show each of the louvered shutters divided into two sections. Marks in the brick surfaces flanking the blinds indicate the locations of pairs of holdbacks that secured the earlier blinds.

ARCHITECTURAL DESCRIPTION



Light well and areaway along north elevation



Passage north of student room No. 53

ORIGINAL PAVILION: NORTH FACADE

The north facade of the original pavilion is three bays wide, with both the middle and west bays west of center. The basement is fully exposed on this facade. Student room No. 53 covers the east half of the first story and basement.

The handmade bricks are laid in a common bond (one header course every five stretcher courses). The common bricks used for this facade, as well as the south and west facades, were less expensive than the “oil stock” brick used for the front of the pavilion. Headers span over the tops of the window openings. The two upper stories rise above a shallow brick water table at the basement level.

A brick garden wall extends west from the student room to enclose a brick retaining wall and light well along the north facade. The deep well, paved with concrete, allows natural light into the north basement rooms.



0 5 10 20 FEET

Top, north elevation
Bottom, section through student room No. 53

ARCHITECTURAL DESCRIPTION



Pavilion IX from the west

There are original window openings in each of the exposed bays: two in the basement; two in the first story, and three in the second story. All of the openings are framed by 4½" wide two-fascia wood architraves (Type T-3) and sit on 2" to 2½" high sills.

Originally, the two basement openings were fitted with 6/3 sash. In the twentieth century, the sash were joined and reset vertically, forming the existing nine-light casement sash. The first and second floor windows retain their original 6/6 sash and are flanked by two-paneled louvered blinds.

ORIGINAL PAVILION: WEST FACADE

The original three-bay-wide west facade is nearly covered by the circa 1831 addition. The common brick is laid up in Flemish bond. When originally constructed, there were basement doorways in the outer bays; a central doorway flanked by windows in the first story; and three windows in the second story, as shown on Jefferson's original 1819 floor plans.

It is not known if the original pavilion had an areaway or retaining wall along the west elevation; the construction of the 1831 addition removed evidence for the appearance of that area.



West elevation

ORIGINAL PAVILION: SOUTH FACADE

The south facade of the original pavilion mirrors the north facade: the middle and west bays are west of center; the basement is fully exposed; and student room No. 55 covers the east half of the first story and basement. The bricks are laid in common bond, five stretchers courses to one header course.

Like the north facade, there are original window openings in each of the exposed bays: two in the basement; two in the first story, and three in the second story. All of the openings are framed by 4½" wide two-fascia wood architraves (Type T-3) and sit on 2" to 2½" high sills. The first and second story windows have original 6/6 sash and flanking two-paneled louvered blinds.

The two original basement windows were approximately 1' 0" shorter than the existing openings. When the openings were enlarged upward, they cut into the bricks that form the water table at the top of the basement level. Narrow slivers of brick currently form the head of each opening. In the southwest opening, a recent two-light horizontal fixed sash



South elevation

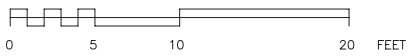

South elevation with parapet

PAVILION IX



Pavilion IX from the south

sits above an air-conditioning unit. The southeast opening is fitted with a pair of twentieth-century four-light casement sash. Horizontal iron bars extend across the exterior of each window.

1831 WEST ADDITION

The circa 1831 west addition, three bays wide and one bay deep, is approximately 3' 0" narrower than the original pavilion. The bricks, which average 8" long by 4" wide by 2½" high, are laid in a modified common bond, with one Flemish bond course every five to six stretcher courses. Ten courses measure approximately 2' 3¾". Although its proportions are slightly different, the profile of the 2' 0" high wood entablature was designed to echo the entablature of the original pavilion. The hipped roof is covered with flat-seamed metal roofing.

ARCHITECTURAL DESCRIPTION



Pavilion IX from the southwest



Basement areaway along the west elevation, looking south; note the arch for the drain at the base of the south wall

Removal of the second-story ceiling from room 207 revealed the original west entablature with its original paint



PAVILION IX

As originally built, the addition had plain brick walls to the north and south. The west elevation included center doorways flanked by window openings at the basement and first story levels, and three windows at the second story.

The north elevation now has one window opening at the first story, probably added in the twentieth century. The window is framed with a 6½" wide two-fascia architrave and fitted with a 6/6 sash.

On the west elevation, the basement still has its 1831 doorway (fitted with a recent board-and-batten door) and flanking windows (framed by 4½" wide single-fascia architraves). A March 2010 probe revealed that the windows initially held double-hung sash. At sometime in the twentieth century, the existing pairs of three-light casement sash were installed. Six horizontal iron bars span each opening. Pairs of twentieth-century shutters are composed of three vertical boards secured with screws to two horizontal, bead-edge battens.

The first story of the addition's west elevation has been altered considerably. When originally built, the center arched doorway was open, without doors or transom. Paint evidence on the brick wall surfaces flanking the arch indicate that there was a narrow porch and probably steps that provided access to the opening. A six-light fanlight now fills the arch, above a doorway framed by a simple 3¾" trim and fitted with a pair of twentieth-century glazed doors, each with four lights. Two courses of corbelled bricks at the springline of the arch extend across the elevation.

The south window opening was lengthened to create a doorway in the later nineteenth-century when the multi-story porch was constructed. The doorway is framed by a 6½" wide two-fascia architrave and fitted with a pair of four-light twentieth-century glazed doors. A horizontal four-light transom is positioned above the doors. Much of the brick masonry in the north bay was removed when the kitchen was extended out onto the west porch.

At the second story, the original window in the center bay was modified to create a doorway when the porch was constructed. The opening is framed by a 6½" wide two-fascia architrave (the same trim as at the first floor door no. 1051) and fitted with a pair of twentieth-century glazed doors, each with four lights. A horizontal four-light transom is positioned above the doors. The flanking circa 1831 window openings have 6½" wide two-fascia architraves and 6/6 sash that appear to be the sash from the corresponding 1822 openings, moved to these locations when the addition was built.

Each of the second-story openings includes pairs of shutters. The two windows feature two-paneled louvered blinds, while the central doorway has a pair of three-panel louvered blinds. The shutters are supported on 1' 3½" long wrought-iron strap hinges set on the typical iron pintles with 1½" high plates. The window shutters date to the twentieth century, but the door shutters may date to the later nineteenth century.

ARCHITECTURAL DESCRIPTION



Arch for drain at the base of the southwest addition's east elevation

When the 1896–1900 southwest addition was built across the first story and basement of the west addition's south elevation, a second-story window was inserted in that facade. The opening is framed by a 6½" wide two-fascia architrave and holds a 6/6 sash.

SOUTHWEST ADDITION

Built in 1896–1900, the one-story and basement southwest addition is two bays wide by two bays deep. The bricks (8" long by 3¾" wide by 2½" high) are laid in a common bond, with one header course every six stretcher courses (except at the top, where there are ten stretcher courses between the header courses). The 1' 4" high wood entablature begins with a large fascia trimmed with an intermediate cavetto molding and a simple crown molding. Above the fascia, a plain projecting fascia is largely obscured by a metal gutter. Slate

PAVILION IX

shingles cover the hipped roof. A brick chimney centered along the west eave of the roof culminates in a two-course cap.

The east elevation of the southwest addition has no window or door openings. At the north end of the elevation, at grade, is a shallow brick arch formed of two rows of headers. The opening, which appears to relate to a perimeter drain pipe, has been closed up with brick and cement; it is now nearly obscured by a shallow concrete trench along the south elevation of the original pavilion. The arch is also visible in basement room B11.

There is a similar arch in the north elevation of the addition, beneath the rear porch (and visible in room B11). The first-story north window opening has a 4¾" wide single-fascia architrave, a 2½" sill, and a 2/2 sash. The two-panel louvered blinds are hung on small cast-iron butt hinges with acorn finials; the wide-swing butt hinge at the bottom of the west shutter leaf is a later replacement. The lower louvers are operable. There is a similar first-story window in the east bay of the west elevation.

When the southwest addition was first built, the south elevation included a first-story doorway in the east bay that opened onto a small porch with stairs descending to grade. Between 1949–1962, a bathroom was installed in the southeast corner of the addition, and the doorway was replaced with a small window framed by a 3½" wide single-fascia architrave, and fitted with a three-light casement sash. A wide, first-story window opening in the west bay has similar trim and blinds as the north and west windows. Side-by-side 2/2 sash are separated by a plain mullion.

In the basement of the south elevation are two small arched window openings. Plain wood frames hold the single-light awning sash. The west window appears to be the earlier of the two openings. At the east opening the lower three courses of brick at each jamb are broken and irregular, possibly indicating that the opening was enlarged at the bottom. Rectangular wood bars extending vertically across each opening were installed circa 1983.

There is a hose bib near the southwest basement window.

WEST PORCH

The three-bay-wide, three-level wood porch projects out one bay from the west elevation of the 1831 addition. This impressive structure replaced a small, narrow porch and stair that originally provided access to the open arched access doorway into the first floor of the west addition. Although the date of construction for the current porch is undetermined, it does not appear in the 1856 Bohn lithograph, but does appear on the 1891 Sanborn maps. It was probably constructed when the pavilion was occupied by Professor McGuffey.

ARCHITECTURAL DESCRIPTION



Second floor of the west porch of Pavilion IX, looking north (left) and south (right)

The bays are delineated by chamfered square columns/posts that rest on basement-level brick piers. Simple wood handrails supported by rectangular balusters span between the columns. A broad staircase, nearly the full width of the center bay, ascends from grade to the first story. At the second story, the column capitals support a plain fascia; above the fascia is a small crown molding. The shed roof is covered in flat-seam sheet metal.

A brick retaining wall extends north to south beneath the porch, creating a brick-paved areaway at the basement level. In the south bay, five brownstone steps, set within brick cheek walls, descend from grade to the passage; the finely carved but well-worn steps have $7\frac{3}{4}$ " high risers and approximately 1' 0" deep treads. These steps appear to be early features, possibly predating the 1831 addition; they may have been used in another location. The brick piers of the porch rest on the brick retaining wall. In the side bays, the spaces between the piers are filled with modern wood lattice.

PAVILION IX

The south end of the areaway is enclosed by the brick wall of the 1891–1906 southwest addition. Centered at the base of the wall is a brick arch (also visible in basement room B11). In the brick paving immediately in front of the arch is the circular opening into the cast-iron drain that extends north/south, below grade, under the arch and areaway.

A plywood partition encloses the north bay of the passage to create a storage space. The doorway in the partition has a plain metal frame and hollow metal door. The ceiling is covered in *Celotex* insulation, and rigid insulation lines the north and west walls. An incandescent utility fixture is mounted to the ceiling. This room was probably created to provide protection for the plumbing lines that service the kitchen (106) above.

At grade, a 10' 10" wide wood stair ascends to the first story of the porch with nine risers straight east. The square-cut treads are 10¾" deep, and the risers 7¾" high. Simple wood handrails extend along the north and south edges of the stair.

At the first floor level, the porch floor is made up of recent 3" wide tongue-and-groove floorboards, laid east/west over recent framing using wire nails. The original ceiling is finished with narrow, loosely spaced boards that run east/west. An electrical light fixture with a paper lantern shade is mounted to the ceiling.

Between 1963 and 1977, the room (106) in the north end of the 1831 addition was enlarged to include the north bay of the porch. The stud frame and plywood partitions enclosing the space are covered with wood lattice. A small window opening in the west partition has a simple frame and a 6/6 sash.

The second floor of the porch has a flat-seamed sheet metal floor. The ceiling is covered with original loosely spaced boards that run north/south, attached to 6" deep joists. Lattice spans between the columns of the north elevation.

STUDENT ROOMS

The original one-story rooms flanking the pavilion, No. 53 to the north and No. 55 to the south, are one bay wide and one bay deep. The rooms' east facades are recessed back 2" from the east elevation of the pavilion.

The common, handmade bricks are laid up in Flemish bond on the east elevation, and common bond (four to five stretcher courses between header courses) on the other elevations. The less expensive common brick has a rougher finish than the adjacent "oil-stock" brick made for the front of the pavilion. The mortar joints are finished in a raised grapevine. The upper eight courses of brick (the depth of the back face of the colonnade entablature) of the east facades are covered in painted stucco.

ARCHITECTURAL DESCRIPTION

Each room has a doorway centered in the east facade and a window opening in the west facade framed with 6½" wide two-fascia architraves. The doorways are fitted with six-paneled stile-and-rail doors. In the window openings are 6/6 wood sash. Two-paneled blinds flank the window and door openings; their hardware includes pairs of wrought-iron strap hinges, typical "J"-type holdbacks at the windows, and iron lift latches on the door shutters. The upper pintle of each door shutter is installed upside down to prevent the removal of the shutter.

Smaller openings in the west elevations access crawlspaces below the rooms. In the north room, the opening is fitted with a board-and-batten panel secured with two slide bolts. The south room's opening has a plywood panel, held in place with butterfly latches.

The later hipped roofs are covered with slate shingles. Originally, the student rooms had serrated roofs, which were covered by wood decks. Remnants of the original wood framing remain beneath the hipped roofs. Original brick chimneys rise from the north end of the north roof and from the south end of the south roof.

EXTERIOR FINISHES INVESTIGATION

The Kutney finishes analysis recorded the following conditions. Sampling of the front porch cornice (wood) revealed twenty-one to twenty-three total finishes, in thirty-six to thirty-eight layers. Dirt layers were apparent between the layers of finish. The earliest three layers of finish were a tan color, of which the earliest matched to Munsell 2.5Y 9/4.

Sampling from the main entablature (west face) of the original 1822 pavilion revealed a different original color. The sample was removed from the entablature surface covered by the 1831 west addition that probably preserved the original, first generation paint finish. The white or off-white [yellowish-white] paint matches to Munsell 5Y 9/2. There is a significant visual difference between the Munsell match 2.5Y 9/4 and 5Y 9/2, but the latter match, visible on protected surfaces of the west entablature, is probably closer to the original exterior trim color. This color is similar to the color found as the first finish on Pavilions I, II, V, and VI.

Samples from the entrance columns, capitals, and column bases, as well as the entrance door architrave, revealed that these wood surfaces were stripped of their paint history during a late twentieth-century restoration campaign. Photographs taken during that restoration record the appearance of the exposed wood surfaces.

Sampling of the curved, plastered wall of the recessed entry revealed approximately twenty-two layers. Dirt was found on the original plaster surface, suggesting that the base

PAVILION IX

plaster was exposed for some time before the first paint finish was applied. This would have been a typical practice for the application of a finish to new plaster. The earliest paint finishes were difficult to access, but the first two layers were whitewashes. The first very thick layer may actually be made up of multiple layers. The Munsell color range extended from 2.5Y 8.5/2 (the lightest) to 2.5Y 8/4 and 2.5Y 6/4, a deep tan color.

ARCHITECTURAL DESCRIPTION

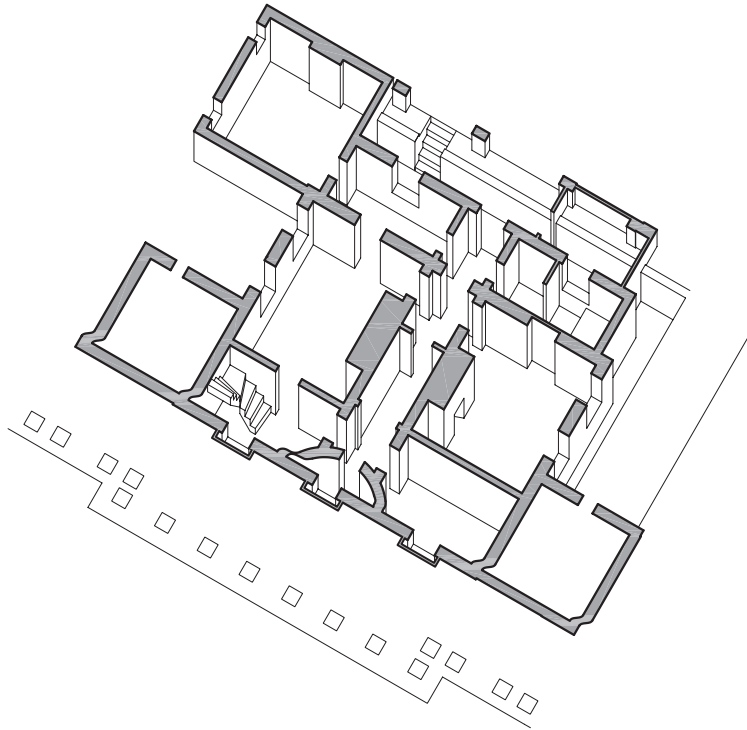

INTERIOR

The original interior of Pavilion IX is arranged in three levels that include a basement, first floor and second floor and continues in the 1831 three-level west addition and a two-level southwest appendage. The interior description begins in the basement of the original 1822 pavilion, continues in the 1831 addition, and ends in the 1896–1900 southwest addition.

BASEMENT

The present arrangement of the basement of the original 1822 pavilion is nearly identical to Jefferson's floor plan. As originally planned and used, the basement included a large stair hall in the southeast corner and an ample kitchen adjacent to the west, with a large cooking fireplace. The east room included a fireplace, and possibly was used by the household servants. According to the construction records and physical evidence, the basement was paved with brick.

The variations that do appear between the current plan and the Jefferson drawing can be accounted for by changes made during the initial construction and in the later nineteenth

PAVILION IX

century. The most obvious differences are the configuration of the stair to the first floor; the partitions in the central hall forming a closet or pantry; and the partition dividing the large north room into two spaces.

Jefferson's plan, curiously, does not provide any access into the semicircular space situated below the recessed first floor entrance niche. Other differences occur with the window openings. The Jefferson plan shows two windows in the east foundation wall, but probes conducted in 2010 revealed that the two windows in those locations are early insertions, probably added by Professor Tucker.

Soon after Professor Tucker occupied the pavilion, he found it necessary to increase its size. By 1831, a narrow, three-story addition was constructed across the rear west facade. At the basement level, this modification added three spaces to the existing plan: a rear entry vestibule flanked by two long, narrow rooms, each with a west-facing window.

The final expansion of the basement occurred at the end of the nineteenth century, between 1896 and 1900, when the southwest addition was constructed, adding a large, unfinished room to the basement plan.

Twentieth-century changes included the replacement of original brick floors with cement and concrete and the modification and enlargement of windows. A bathroom was inserted in the northwest room of the 1831 addition.

ARCHITECTURAL DESCRIPTION

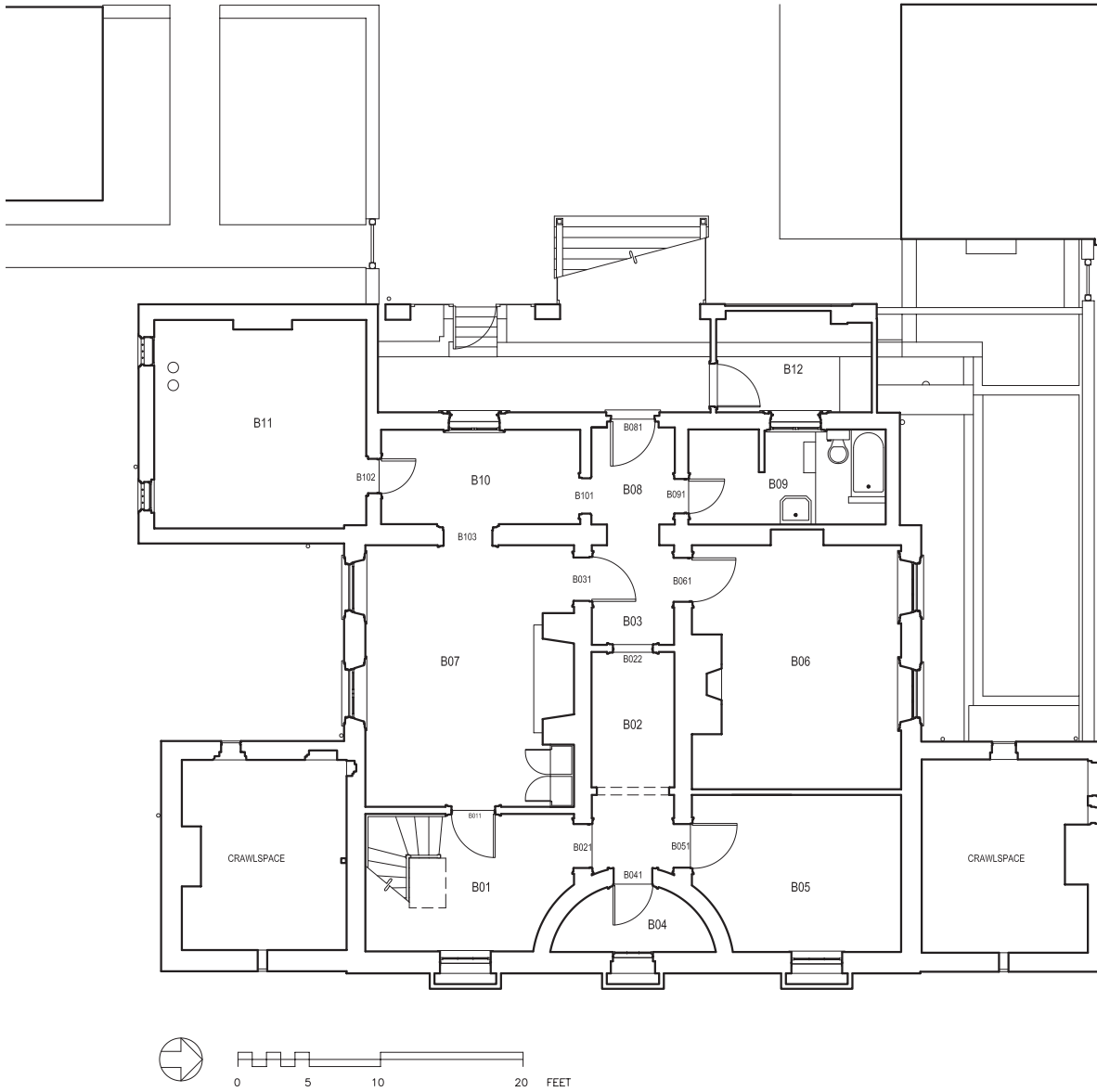

Basement plan



Section looking south

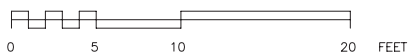

Section looking east

ARCHITECTURAL DESCRIPTION



Room B01 (Stair Hall), looking north

ROOM B01 STAIR HALL

The 14' 7½" by 9' 7" stair hall in the southeast corner of the basement includes doorways in the north and west walls, a small window high in the east wall, and a stair, arranged in three runs, that rises against the south wall. The curved wall surface in the northeast corner is the foundation wall of the recessed entry niche. The stair configuration, which is original, differs from the one shown on Jefferson's 1819 floor plan.

The hall retains much of its original character, except for the recent brick floor.

Floor: Brick pavers (3½" by 8") are laid in a herringbone pattern. This recent surface is approximately 2" higher than the original floor.

Walls: The north, east, south, and curved northeast walls are plaster on original brick masonry. The wood-framed west partition is finished with plaster.

Ceiling: The original plaster ceiling is 7' 8½"

above the recent floor.

Doors: The original west doorway is framed with a 4¾" wide single-fascia architrave with a small bead at the inside edge. The wood jamb is original, but the trim is a later replacement. The original north doorway has a 5" wide original single-fascia architrave, trimmed with a larger bead at the opening.

No. B011: The original 3' ½" wide by 6' 2" high board-and-batten door is made up of 3½" to 6" wide, 1½" thick, tongue-and-groove beaded battens on the east face (Type D-5). Hardware: The door hardware includes a pair of original 3½" high iron butt hinges; a later 3¼" by 3¾" cast-iron rim lock on the east face with brown mineral knobs; and a later iron keyhole escutcheon on the west face. The outline for an earlier, possibly original 4" by 6" rim lock is visible above the current lock.

Window: Probes carried out in May 2010 re-

PAVILION IX



Room B01 (Stair Hall) window during 2010 probe; the probe revealed that the window was inserted after construction

vealed that the window opening high in the east wall is a later insertion, probably dating from the occupancy of Professor Tucker. Jefferson's basement plan includes a window in this position, but apparently one was not in the construction as completed in 1822.

The trim at the existing opening is made up of plain boards. The six-light awning sash is composed of two separate horizontal sash that originally functioned with a vertically sliding lower sash and upper fixed sash. A wood turn button secures the sash closed. The sash has 10" by 12" panes, $\frac{5}{8}$ " muntins, and a pair of butt hinges on the upper rail. Horizontal iron bars extending across the exterior of the opening are old, but may not be original to the opening.

Stair: The original open-string wood stair begins near the west wall, ascending four risers south to a landing, then six risers east to a landing, and four risers north to reach the first floor. The

treads are angled, slightly radiating out from the center. The stained, varnished, bullnosed treads range from 10" deep at the interior edge to 1' 1" deep along the exterior edge. The $8\frac{1}{4}$ " high risers (including a 1" nosing) are trimmed with a small cavetto molding beneath the nosing; the bottom riser is just 6" high, due to the higher level of the recent brick floor. The string brackets are stylized "C"-scrolls.

The original $2\frac{1}{8}$ " wide by 2" high shaped mahogany handrail is supported by rectangular $\frac{3}{4}$ " by 1" balusters, spaced $2\frac{7}{8}$ " to $3\frac{1}{4}$ " apart (three per tread). The rail extends between 3" by 3" turned wood newel posts.

An original wood beam trimmed with flush beads extends at the first floor level from the west to east walls to support the stair carriage. A narrow molding trims the top edge of the north face of the beam. The bottom ends of the two first-floor newels are exposed along the south face of the

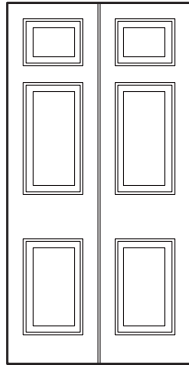

D-1 (DOOR NO. 1011)

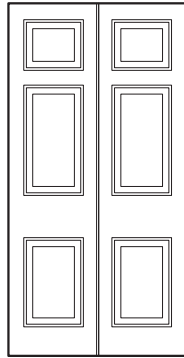
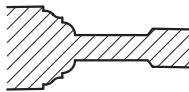

D-2 (DOOR NO. 1012)

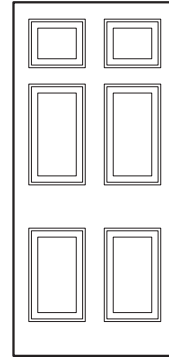
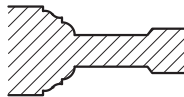

D-3 (TYPICAL ORIGINAL INTERIOR DOOR)

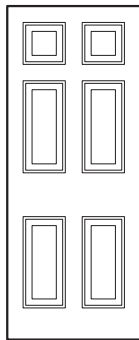
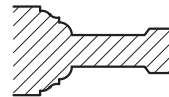

D-4 (DOOR NO. 2032)

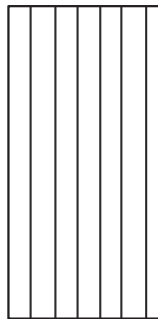
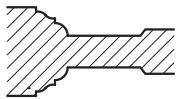

D-5 (TYPICAL ORIGINAL BASEMENT DOOR)

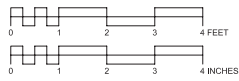
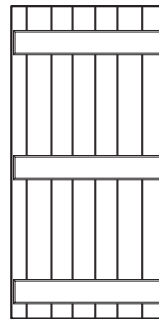

PAVILION IX

beam; at the south newel, the bottom surface is finished with a disk and acorn ornament.

Heating: A six-column, twenty-section, cast-iron hot water radiator is positioned below the east window. Insulated hot water pipes extend along the east wall and through the north and west walls.

Lighting/electrical: A recent incandescent fixture with an opal glass dome shade is mounted to the ceiling. Other electrical elements include a switch on the west wall, and electrical conduit along the east wall.

Furnishings and fittings: An early, possibly original, 2½" high wood rail with recent wood pegs is mounted to the curved northeast wall, 5' 4½" above the floor.

Finishes investigation: No samples from this space were analyzed.

ROOM B02 HALL

This central hall extends east/west, separating the primary basement rooms. The long, narrow, 5' 10" by 15' 11" space includes a single doorway in each wall. The curved east wall forms part of the foundation of the recessed entry niche.

The 1819 Jefferson floor plan shows a single long hall that includes the area west of this space (B03). Probes carried out in May 2010 revealed a different configuration. As originally completed, this space included a large closet or pantry that filled the center of the hall seen on Jefferson's plan. The original doorway that connects B02 and B03 provided access to the closet. The east partition that enclosed the closet was largely removed in the twentieth century, but the encased frame at the east end of the hall marks the location.

Floor: The recent wall-to-wall carpet that covered the cement floor was removed in March 2010.

Walls: The north, south, and curved east walls are plaster on original brick masonry. The original wood-framed west partition dividing the long hall into separate areas is finished with plaster and includes a doorway.

Near the east end of the hall, 6¼" wide wood boards support an encased header extending north/south. This trim conceals the remnants of the original partition that enclosed the east end of the hall.

Ceiling: The original plaster-on-lath ceiling is 7' 11" above the floor.

Doors: The original doorways in the east and west walls, and the doorways at the east end of

the north and south walls, are framed with 5" wide single-fascia architraves, each trimmed with a large bead at the opening.

No. B021: The door has been removed from this opening. Evidence for original butt hinges on the west jamb indicate that the door opened to the north. The east jamb retains the keeper for a Carpenter-type lock. This lock type dates to the 1830s or later.

No. B022: There is no door in the opening. Marks on the north jamb for a pair of original 3½" high butt hinges indicate that the door opened to the east. The cast-iron keeper for the original rim lock remains on the south jamb. The jamb profile reveals that the door was planned to open towards the west, but was installed opening to the east.

Heating: Insulated hot water pipes extend from the north wall to the south wall (between rooms B06 and B07).

Lighting/electrical: An incandescent porcelain utility fixture with a pull string is mounted to the ceiling. Rigid electrical conduit extends along the ceiling.

Furnishings and fittings: A crude wood shelving unit is positioned along the south wall.

The central section of this hall originally was a closet or pantry. Possible evidence for shelving or other fittings on the north and south walls may be concealed by a layer of later plaster and paint.

Finishes investigation: No samples from this space were analyzed.

ROOM B03 HALL

This small, 5' 9½" by 7' 0" hall includes single door openings in each wall. The 1819 Jefferson floor plan shows this area as part of the long central hall that divides the basement. That plan does not show an opening in the west wall and it may date to the construction of the first rear addition circa 1831.

Floor: The recent wall-to-wall carpet that covered the cement floor was removed in March 2010. The floor is slightly higher than the surface in B02.

Walls: The original north, south, and west walls are plaster on original brick masonry. The original wood-framed east partition is finished with plaster. The doorway in this partition provided access to a closet or pantry originally at the west end of B02.

Ceiling: The original plaster-on-lath ceiling is 7' 9½" above the floor.

Doors: The original doorways in the north and south walls are framed by 5" wide single-fascia

ARCHITECTURAL DESCRIPTION



Room B02, looking east



Room B03, looking west.

architraves, each trimmed with a large bead at the opening. The east doorway has a similar architrave that is $4\frac{3}{4}$ " wide. The west opening has only a bullnosed lintel; Jefferson's plan does not show an opening in this location.

No. B031: The original $3' 0\frac{3}{4}$ " wide by $6' 1"$ high board-and-batten door is made up of $4\frac{3}{4}$ " to $5\frac{1}{2}$ " wide, $1\frac{1}{8}$ " thick, tongue-and-groove beaded boards fastened to three horizontal, beveled-edge battens (Type D-5). Hardware: The door hardware includes an original pair of $3\frac{1}{2}$ " high cast-iron butt hinges; a later $3"$ by $3\frac{3}{4}"$ cast-iron rim lock on the north face with brass knobs; and a rectangular iron keyhole escutcheon on the south face. There is an outline for an earlier, probably original, $4"$ by $6"$ rim lock above the current lock. This door was originally hinged to the west jamb and opened into the kitchen.

Heating: Radiator pipes extend north/south at

the west end of the ceiling (between rooms B09 and B10).

Lighting/electrical: An incandescent porcelain utility fixture with a pull string is mounted to the ceiling. Rigid electrical conduit extends along the ceiling.

Finishes investigation: No samples from this space were analyzed.

ROOM B04 STORAGE

This unusual, half-round room is currently used for storage as well as a "wine cellar." The $11' 6\frac{1}{2}"$ by $4' 7"$ room includes a doorway in the curved west wall and a small window set high in the flat east wall. The shape of this room reflects the shape of the curved entrance niche at the first floor.

Jefferson's 1819 basement floor plan includes this area but shows no access doorway from the

PAVILION IX



Room B04, looking north



Room B05, looking north

central hall, and no window in the east foundation wall. The doorway is original but the window is probably a later insertion.

Floor: Old cement covers brick pavers that may be original.

Walls: The walls are original brick masonry. In the curved wall, the 2½" by 8" by 3¾" bricks are laid in American bond with alternating stretcher and header courses, such that ten courses are 2' 5½" high.

The east wall is heavily coated, but appears to be laid up with one header course every two to three stretcher courses.

Ceiling: The ceiling is made up of the wood framing for the east entry porch deck. The five 11½" deep, 2" thick joists, 8' 3" above the floor, extend north/south to support the floorboards. An extra ledger board on the west wall adds additional sup-

port to the first floor entrance threshold.

Door: The original west doorway is framed by a recent 5" wide single-fascia wood architrave.

No. B041: The recent 2' 8¾" wide by 6' 4¼" high board-and-batten door is made up of 1½" thick, tongue-and-groove beaded boards fastened to three horizontal, beveled-edge battens. Hardware: The door hardware, contemporary with the recent door, includes a pair of 3½" high iron butt hinges; a 3¼" by 3¾" rim lock on the east face with brass knobs; and an oval brass keyhole escutcheon on the west face.

Window: The frame at the small window high in the east wall is made up of plain boards. The six-light awning sash has 10" by 12" panes and ⅝" muntins. A wood turn latch secures the bottom of the sash.

Horizontal iron bars extending across the exte-

ARCHITECTURAL DESCRIPTION

rior are old but may not be original to the opening.

Heating: Insulated hot water pipes extend along the east wall, below the window.

Lighting/electrical: An incandescent porcelain utility fixture with a pull string is mounted to the ceiling. Rigid electrical conduit and flexible armored cables extend along the ceiling, and EMT (electrical metallic tubing) runs north/south along the east wall.

Finishes investigation: No samples from this space were analyzed.

ROOM B05 STORAGE

This 14' 8" by 10' 10½" storage room includes a single doorway in the south wall and a narrow window high in the east wall. The 1819 Jefferson plan of the basement shows this space and the adjoining area (B06) as a single large room. Although the current partition separating the two rooms is a recent insertion, it may replace an early, possibly original wall. Inspection of the north and south wall surfaces in the location of the current partition revealed bare, unplastered brick, indicating that the spaces were always divided.

Floor: Well-worn cement covers brick pavers. The pavers are old, and may be original.

Walls: The north, east, south, and curved southeast walls are original brick masonry, finished with a recent plaster skim coat over original plaster. The recent west partition, built with 2" by 4" wood studs, is finished with gypsum board. In May 2010, the framing was inspected, revealing that the west partition may replace an earlier original partition in the same position.

Ceiling: The gypsum board ceiling is approximately 7' 11" above the floor. The clean wood underside of the later replacement flooring in room 102 is visible above the west partition.

Door: The original south doorway is framed by a 4¾" wide single-fascia wood architrave, trimmed with a large bead at the opening.

No. B051: The original 3' 1½" wide by 6' 1" high board-and-batten door is made up of 5" to 5½" wide, 1⅞" thick, tongue-and-groove beaded boards fastened to three horizontal, beveled-edge battens. A later cutout in the door, filled with wire mesh, forms a small vision/ventilation panel. Hardware: The door hardware includes a pair of recent 3" high iron butt hinges; a 3" by 4" cast-iron rim lock on the north face with black knobs; an oval keyhole escutcheon on the south face; and a *Corbin*

deadbolt. The locations for two earlier keyholes are visible. It is not clear whether a rim lock or latch was originally used on this door. A wood hand grip is attached to the south face of the door.

Window: The frame at the later small window opening high in the east wall is made up of plain boards. The six-light awning sash is similar to the reworked sash in B01. The sash has 10" by 12" panes, ⅝" muntins, and a pair of butt hinges on the upper rail. Horizontal iron bars extending across the exterior are old, but may not be original to the opening.

Heating: Insulated hot water pipes extend along the east wall, below the window. Radiator pipes, near the ceiling, run north/south through the room and through the west partition (into room B06).

Lighting/electrical: The room is lit by an incandescent utility ceiling fixture. Other electrical elements include a switch on the south wall and electrical conduit along the east wall.

Furnishings and fittings: The room includes large, mid-twentieth-century storage units, fitted with sliding wood doors and trimmed with small crown moldings: one unit on the east wall; one on the north wall; and a three-bay-unit on the west wall. The units were removed in March 2010.

Finishes investigation: No samples from this space were analyzed.

ROOM B06

Most recently, this room functioned as a family play room. The large, 14' 8" by 17' 0½" room includes a single doorway in the south wall and two windows in the north wall. A recess in the west wall probably was a doorway. A wide chimney breast, with covered-over fireplace (revealed in a March 2010 probe), projects from the south wall.

The 1819 Jefferson basement floor plan shows this space and the adjacent area (B05) as a single large room, but physical evidence seems to indicate there was always a partition separating the spaces. The original function of this room has not been determined, but the fireplace indicates that this room was an occupied space.

Floor: The recent wall-to-wall carpet that covered the floor was removed in March 2010 to reveal the old cement or concrete floor (positioned slightly higher than the floor surface in B05).

Walls: The north, south, and west walls are covered in a recent plaster parging over original plaster on original brick masonry. The recent east wall, made up of 2" by 4" wood studs, is finished with

PAVILION IX



Room B06, looking southeast

gypsum board. This surface appears to replace an earlier, possibly original, partition.

A 3' 8½" wide by 5' 10½" high recess, centered in the west wall, is in the location of an original opening, possibly a doorway, shown on Jefferson's 1819 floor plan.

Ceiling: The recent gypsum board ceiling is 7' 10" above the floor.

Door: The original south doorway is framed by a 5" wide single-fascia architrave, trimmed with a large bead at the opening.

No. B061: The original 3' 0¾" wide by 6' 2½" high board-and-batten door is made up of 4" to 6" wide, 1½" thick, tongue-and-groove beaded boards fastened to three horizontal, beveled-edge battens. Hardware: The door hardware includes a pair of later 3½" high cast-iron butt hinges; a later 3¼" by 4" iron rim lock on the north face with brown mineral knobs; and a rectangular iron keyhole escutcheon on the south face. There is evi-

dence for an earlier keyhole position, possibly for a larger original rim lock and for smaller 2½" butt hinges.

Windows: The two original windows in the north wall have 5" wide single-fascia architraves that frame splayed reveals lined with plain wood panels. The openings sit above 1½" bullnosed sills, 2' 3" above the floor. The casement sash are made up of 6/3 double-hung sash original to the 3' 5½" square openings. In the twentieth century, the original sash with 12" by 12" panes and ¾" muntins were removed and joined to form a single casement in each window, installed with the units positioned vertically. The casement hardware includes a pair of iron butt hinges and a brass latch at each sash.

Fireplace: The original 7' 0" wide brick foundation of the north chimney projects 2' 1" from the south wall. Vertical beads trim the outer corners. A March 17, 2010 probe removed the brick and plaster covering the original firebox. The investiga-

ARCHITECTURAL DESCRIPTION



Room B07 (original kitchen), looking northeast

tion revealed a 2' 2½" wide by 2' 6" high opening. An iron beam and a segmental brick relieving arch extend across the top of the opening. This opening was originally larger, at 3' 0" wide and 2' 10" high at the center of the arch.

The Jefferson floor plan does not show a chimney breast or fireplace in this room, but it is likely that this is an original feature.

Heating: A four-column, eleven-section, cast-iron, hot-water radiator is positioned between the two north windows. Insulated hot water pipes extend through the east end of the north wall and through the west and south walls (into rooms B02 and B09).

Lighting/electrical: A recent fan with three incandescent bulbs is mounted to the ceiling. Other electrical fittings include a switch on the south wall.

Furnishings and fittings: There is recent built-in shelving on the west recess and in the area east of the chimney breast.

The west shelving was removed in April 2010.

Finishes investigation: No samples from this space were analyzed.

B07 ORIGINAL KITCHEN

This large, 14' 7½" by 18' 4½" room was the original basement kitchen. The room includes single doorways in the north, east and west walls, and two windows in the south wall. A broad chimney breast and fireplace are centered on the north wall. These conditions are shown on Jefferson's 1819 floor plan.

Originally, the prepared food was carried from this room, up the staircase, to the first floor dining room (103). Later in the nineteenth century, a dumbwaiter may have been installed in the northeast corner of B10, making the serving process much more efficient.

Floor: The recent wall-to-wall carpeting that covered the cement floor was removed in March

PAVILION IX



Closet in northeast corner of B07



Wallpaper fragment found in B07 closet.

2010. The original surface was probably brick.

Walls: The north, west, and south walls are plaster on original masonry. The original wood-framed east partition is finished with plaster.

Ceiling: The plaster ceiling is 7' 9¼" above the carpet.

Doors: The north and west doorways have original 5" wide single-fascia architraves, each trimmed with a large bead at the opening. Evidence for hinges on the west jamb of the north opening indicates that the door (B071) originally opened into the kitchen.

The east doorway has an original jamb and a later 4¾" single-fascia architrave with a smaller flush bead at the edge.

Windows: The two window openings in the south wall have 4¾" wide single-fascia architraves that frame splayed reveals lined with plain wood panels. The openings sit above ¾" bullnosed sills. These

openings are original, but were enlarged vertically at an undetermined date. The trim profile matches that of the later east door. A comparison of the trim at these modified openings with the original openings in the north room (B06) reveals how they were enlarged. In B06, the wall surface above the trim is 1' 8" and the sill is 2' 3¼" above the floor. In the kitchen, the openings were increased vertically approximately 1' 0": the surface above the trim is 1' 1¼" while the sill is 1' 11" above the floor.

In the southwest opening, a recent two-light horizontal fixed sash sits above an air-conditioning unit. The unit is flanked by acrylic panels. The locations for the casement window hinges are visible on the window frame. Horizontal iron bars extend across the exterior.

The southeast opening is fitted with a pair of twentieth-century four-light casement sash. Sash hardware includes pairs of 3" iron butt hinges, slide

ARCHITECTURAL DESCRIPTION

bolts on the top and bottom rails of the east sash, and a brass and iron sash latch.

Fireplace: The original 9' 2 $\frac{3}{4}$ " wide brick chimney breast projects 2' 2 $\frac{3}{8}$ " from the north wall. The 5' 7 $\frac{1}{2}$ " wide segmental arched opening is 3' 2" high at the outer edges, and 3' 6 $\frac{1}{2}$ " high at the highest point. The brick firebox is 2' 4" deep. The original upper iron support pin for the pot crane survives in the northwest corner of the firebox.

The carpeting partially covers the brick hearth, which is made up of bricks laid in a running bond.

A probe conducted in March 2010 revealed that a stove pipe thimble remains embedded at an angle in the center of the chimney breast, at 6' 10" above the floor (on center). This feature would date to the later nineteenth century, when a range was used for cooking.

Heating: A four-column, fifteen-section, cast-iron hot water radiator is positioned on the south wall between the two windows. Hot water pipes extend east/west through the room, splitting off to run to the radiator and through the north, west, and east walls.

Lighting/electrical: A fixture with an opal glass domed shade is mounted to the ceiling. Other electrical elements include a switch in the east wall; duplex receptacles in the east and west walls; and two duplex receptacles on the west face of the chimney breast. An old electrical box is mounted to the east end of the south wall.

Furnishings and fittings: An early, circa 1830s, built-in cabinet fits between the chimney breast and the east wall. The cabinet has two doors, each 1' 9" wide by 5' 8 $\frac{1}{2}$ " high by 1 $\frac{1}{4}$ " thick with two recessed panels. The door hardware includes pairs of 3" iron butt hinges, later brass latches, and original iron key escutcheons. There are mortises for missing original cabinet locks. Within the cabinet there are five original tiers of shelves. A sixth shelf is concealed in the upper portion of the cabinet created when the doors were cut down and fixed wood panels enclosed the upper area.

Finishes investigation: A probe of the enclosed upper area of the early built-in cabinet, carried out in March 2010, revealed an important wall treatment behind the cabinet. The north wall retains an early block-pattern wallpaper. The white rag paper is finished in a pale grey painted ground with an imprint of black and white "specks." The 8" high blocks are defined by white painted mortar joint lines. The sequence followed to create this "block" paper began with the application of the

ground paint followed by the black specks, the white specks, and finally the mortar lines. The paper is applied over at least two finishes of a pale yellowish white. The use of this paper in a kitchen seems unusual, and it is possible that this paper is left over from an application in the first floor entrance hall or stair hall, where block papers were typically placed; the first floor finishes analysis revealed a trace of wallpaper fibers on the first floor hall (101) walls.

The Kutney finishes analysis in the basement kitchen (B07) sampled the door and window architraves and the north wall. None of the revealed color layers were matched to the Munsell color system, but the comparison of the finish layers confirmed the later date of the trims at the east doorway and the southeast window.

ROOM B08 REAR VESTIBULE

This vestibule, centered in the addition added to the west side of Jefferson's original circa 1822 pavilion, functions as the rear entrance to the basement. The 5' 9 $\frac{1}{2}$ " by 6' 9 $\frac{1}{2}$ " space includes a single doorway in each wall. The opening in the east wall that provides access into the central basement hall was probably created at the time of the construction of the circa 1831 addition.

Floor: The recent wall-to-wall carpet that covered the cement floor surface was removed in March 2010.

Walls: All four walls are plaster on brick masonry. The east wall is the original west foundation wall of the circa 1822 pavilion.

Ceiling: The plaster-on-lath ceiling is 7' 8 $\frac{1}{2}$ " above the carpet.

Doors: The trims at the four doorways differ. The west entrance has a plain casing. The upper portion of the opening, which may have held a glazed transom, is infilled with two horizontal boards. The north doorway is framed with a later 4 $\frac{1}{2}$ " wide single-fascia architrave. An original 1 $\frac{1}{2}$ " quarter-round bead trims the south opening. There is no trim at the east opening, only a bullnosed lintel composed of two 1 $\frac{1}{8}$ " thick boards. This opening probably did not exist until the rear addition was constructed.

No. B081: The recent 3' 1 $\frac{1}{2}$ " wide by 6' 5" high board-and-batten door is made up of 5 $\frac{1}{2}$ " to 6 $\frac{1}{2}$ " wide, $\frac{7}{8}$ " thick tongue-and-groove beaded boards, screwed to three horizontal battens. Hardware: The hardware, contemporary with the door, includes

PAVILION IX



Room B08 (Vestibule), looking west

a pair of 4" high iron butt hinges; a small, 4¼" by 3" sheet-iron rim lock with brass knobs; a *Corbin* deadbolt; and a brass slide bolt. There is evidence on the south jamb for strap-type or "HL"-type hinges that would have supported the original door.

Heating: Insulated hot water pipes extend north/south across the ceiling.

Lighting/electrical: The vestibule is lit by an incandescent porcelain utility fixture on the ceiling. Other electrical elements include a *Square D* electrical panel and a switch (for the pump) on the south wall, and a switch on the north wall.

Finishes investigation: No samples from this space were analyzed.

B09 BATHROOM/LAUNDRY

This two-level bathroom at the north end of the addition to the original pavilion is 13' 10" by 6' 8½".



Room B09 (Bathroom), looking north

The long, narrow room includes a doorway in the south wall and a window in the west wall. There was a doorway in the east wall, but it was probably removed when the platform (that would partially cover it) was constructed in the twentieth century.

Floor: 9" square vinyl tiles (white with black streaks) cover the cement floor. At the north end of the room, a wood step leads to a 1' 6½" high masonry and cement platform finished with the same tiles.

Walls: The east wall is original circa 1822 brick masonry, covered in later plaster. The other three surfaces are circa 1831 brick walls of the west addition. The north and west walls are finished in gypsum board. A recent wood-framed partition projecting from the west wall, near the window opening, separates the laundry area from the bathroom.

Ceiling: The original, circa 1831 plaster-on-lath

ARCHITECTURAL DESCRIPTION



Room B10, looking north

ceiling is 7' 8" above the floor.

Baseboard: A black vinyl base, contemporary with the tile floor, trims the west wall below the window and along the bathtub platform.

Door: The south doorway is framed with a later 4½" wide single-fascia architrave. Originally, this opening probably had the same bullnose bead trim that is used at the south opening (B101) in the vestibule (B08).

No. B091: The original, circa 1831, 2' 5¾" wide by 5' 8¼" high board-and-batten door is made up of 9¾" to 10" wide, ¾" thick, tongue-and-groove beaded boards fastened to three horizontal battens with clinched cut nails (D-5). The battens are trimmed with flush beads at the edges. Hardware: Door hardware includes a pair of 3½" high iron butt hinges; a later 4" by 3½" iron rim lock on the north face with iron, brass-plated knobs; and an oval keyhole escutcheon on the south face. There

are outlines for two earlier rim locks above the current lock: a 5" by 7½" rim lock (probably original); and a small vertical rim lock.

Window: The circa 1831 window opening in the west wall is framed by an original 4½" wide single-fascia architrave, simpler than the typical architraves on this floor. The opening sits above a bullnosed sill. In the opening is a pair of twentieth-century casement sash, each with three 12" by 17" panes, ¾" muntins, and pairs of 3" lift-off iron hinges. The north sash also has a brass latch and a slide bolt on the bottom rail. In the south sash, the lowest pane has been removed to accommodate the dryer vent.

In March 2010, the window was investigated for evidence of earlier conditions. The probe revealed that the opening was originally fitted with double-hung sash. Six horizontal iron security bars in the opening were installed after the double-hung sash

PAVILION IX

were removed.

Heating: A three-column, nine-section, cast-iron, hot water radiator is positioned near the east wall. Heating and plumbing pipes extend north/south through the room, largely covering the ceiling.

Lighting/electrical: An incandescent porcelain utility fixture is mounted to the ceiling, and there is a fluorescent wall fixture above the lavatory on the east wall. Other electrical elements include a switch in the south wall and receptacles for the washer and dryer on the west wall.

Plumbing: The twentieth-century bathroom fittings include an enameled cast-iron lavatory on the east wall, marked "3-2-59E NO 1 4;" a vitreous china toilet on the west wall, sitting on the platform, marked "10337 8 9 62 6 K4522" (possibly indicating that the toilet dates to 1962); and an enameled cast-iron bathtub in the northwest corner on the platform. At the east end of the bathtub, a small partition encloses the plumbing lines to the faucet and knobs.

In the laundry area, water lines to the washer extend down the west wall.

Furnishings and fittings: A plastic medicine cabinet with mirror is mounted to the east wall, above the lavatory.

Finishes investigation: No samples from this space were analyzed.

ROOM B10

Most recently, this long, narrow room functioned as an office. The 13' 11½" by 6' 7" room includes doorways in the north, south, and east walls and a window in the west wall. The east opening was originally an exterior doorway that provided access to the kitchen (B06). This room and the two rooms to the north (B03 and B09) make up the basement of the circa 1831 addition.

Floor: The recent wall-to-wall carpet that covered the cement floor was removed in March 2010.

Walls: The east wall is the original brick masonry of Jefferson's pavilion; the other three walls are the circa 1831 brick of the addition. Originally, the exposed brick was painted. Later plaster covers the north, east, and south walls. The west wall is covered in gypsum board.

Ceiling: The original plaster-on-split-lath ceiling is 7' 11" above the floor. In the northeast corner, possibly the former location for a dumbwaiter, the surface is plaster on sawn lath.

Doors: The three doorways (one in the north wall, one in the east wall, and one to the south) each have different architraves. The east opening is the original exterior doorway to the kitchen of Jefferson's pavilion, and the 6" wide two-fascia architrave matches the original exterior trim. The north opening is framed with a 4" wide single-fascia architrave trimmed with a large bead at the inner edge. At the south opening, the 4¾" wide single-fascia architraves has a nineteenth-century bead and quirk ogee molding, similar to the architraves in Room 108.

No. B101: The door is missing, but the east jamb retains markings for two 3" hinges; the west jamb retains the keeper for a rim lock. The missing door opened out into the hall. There is evidence for a pair of 3½" butt hinges on the west jamb (the B10 face) where the original door was hinged to open to the south.

No. B102: The 2' 4¾" wide by 6' 2½" high by 1¼" thick stile-and-rail door has four raised panels. The door is contemporary with the opening created when the southwest addition was constructed (circa 1896-1900). Hardware: The hardware is original to the door, and includes a pair of 3¼" high iron butt hinges; a 3¼" by 4" cast-iron rim lock on the north face with mineral knobs; and a cast-iron keyhole escutcheon on the south face.

No. B103: There is no door in this opening, but evidence for two 2½" high hinges on the north jamb in room B07 indicate that the original door opened into that space. Evidence for two 1' 0" high wrought-iron strap hinges remains on the south jamb, indicating that at a later date, the door opened to the west. There is a 4" high cast-iron keeper on the north jamb for a rim lock, and evidence for a larger 4¾" keeper above.

Window: The circa 1831 window opening in the west wall is framed by a 4½" wide single-fascia architrave. The opening sits above a bullnosed sill. In the opening is a pair of twentieth-century casement sash, each with three 12" by 17" panes, ¾" muntins, and pairs of 3" iron lift-off hinges. These conditions match those in the bathroom (B09), indicating that originally a double-hung sash was used in this opening. Horizontal iron security bars have been installed in the opening.

Heating: The ceiling is largely concealed by insulated heating pipes and plumbing pipes that extend north/south.

Lighting/electrical: A porcelain utility fixture on the ceiling has been adapted for use as a duplex

ARCHITECTURAL DESCRIPTION



Room B11, looking northeast

receptacle. Other electrical elements include a duplex receptacle on the east wall.

Finishes investigation: No samples from this space were analyzed.

ROOM B11

The large, 14' 10½" by 14' 7½" basement of the southwest addition is currently used as a workroom. The nearly square room includes a doorway in the north wall and two small windows low in the south wall. There is no evidence that the room ever received any kind of finish. The exact date of the addition has not been determined, but it does not appear on the 1896 Sanborn map and can be seen in a 1900 photograph.

Floor: Concrete.

Walls: All four walls are brick, laid up in American bond with one header course every six stretcher courses. The brick are 2½" by 8" by 3¾"; ten courses are approximately 2' 4¾" high. A portion of the

original exterior basement wall of the circa 1822 pavilion projects into the northeast corner of the room. The section of wall immediately to the west, including the doorway, is the south face of the circa 1831 addition foundation wall. The remaining walls date to the construction of the southwest addition.

There is a construction joint in the north wall, 6' 7" from the west wall. To the east of that joint, the bricks are 2⅝" by 7¾" by 3¾", and are laid up in a stretcher bond such that ten courses are 2' 4" high. At the construction joint there is an 8" wide vertical section of broken bricks, beginning 1' 11" above the floor, covered with parging. This may be the position of a garden wall that was removed when the southwest addition was constructed.

The north and east walls each feature a low brick arch, positioned at floor level. At each location, two rows of headers form the shallow arch. The north arch is about 3' 3" wide and 9" high; the east arch is 2' 11" wide and about 1' 2" high. The openings are now closed with brick and cement. They seem to

PAVILION IX

relate to a perimeter drain pipe flowing downhill from east to west, turning the corner and continuing to the north. The pipe is partially exposed on the north face of the north arch and in the exterior areaway beneath the west porch.

Ceiling: The ceiling is made up of the unfinished framing for the floor of Room 108. The 1¾" by 9½" joists run east/west, and are spaced approximately 1' 8" apart (on center). The joists support 3" wide tongue-and-groove floorboards, 8' 8½" above the floor. X-bracing between the joists is secured using wire nails.

Door: The doorway in the north wall has no trim, only a wood lintel at the head of the opening. This doorway was created to provide access from the earlier west addition into this later space.

Windows: The two small window openings in the south wall have plain wood frames. The construction details are different for each opening. The west window is more carefully detailed and appears to be the earlier of the two.

In each opening, a single-light awning sash has a pair of 3" butt hinges on the upper rail. The southeast sash can be held open with a hook on the bottom rail. Wood pivots secure the sash when closed.

Rectangular wood bars extending vertically

across the exterior of the openings may date to the 1980s, as they are shown in a set of 1983 drawings.

Chimney: The 4' 1½" wide brick foundation for the fireplace and chimney in room 108 projects 8" from the west wall. The ceiling joists are framed around the chimney breast, and cribbing supports the room 108 hearth.

Heating: There are three cast-iron, hot water radiators in the room: a three-column, eleven-section unit on the south wall; a four-column, six-section unit on the west wall, south of the chimney breast; and a three-column, thirteen-section unit on the west wall, north of the chimney breast. Insulated hot water pipes for the heating system extend along the east and south walls, and to the radiators.

Lighting/electrical: The room is lit by a porcelain utility fixture fastened to a joist. Other electrical elements include switches on the south and west walls; duplex receptacles on the north and east walls; electrical panels on the west and south walls; and a *Square D* panel box on the chimney breast.

Plumbing: A *Ruudglas Pacemaker* eighty-gallon water heater is positioned near the chimney breast. Domestic water lines extend through the south and north walls.

Finishes investigation: No samples from this space were analyzed.

ARCHITECTURAL DESCRIPTION

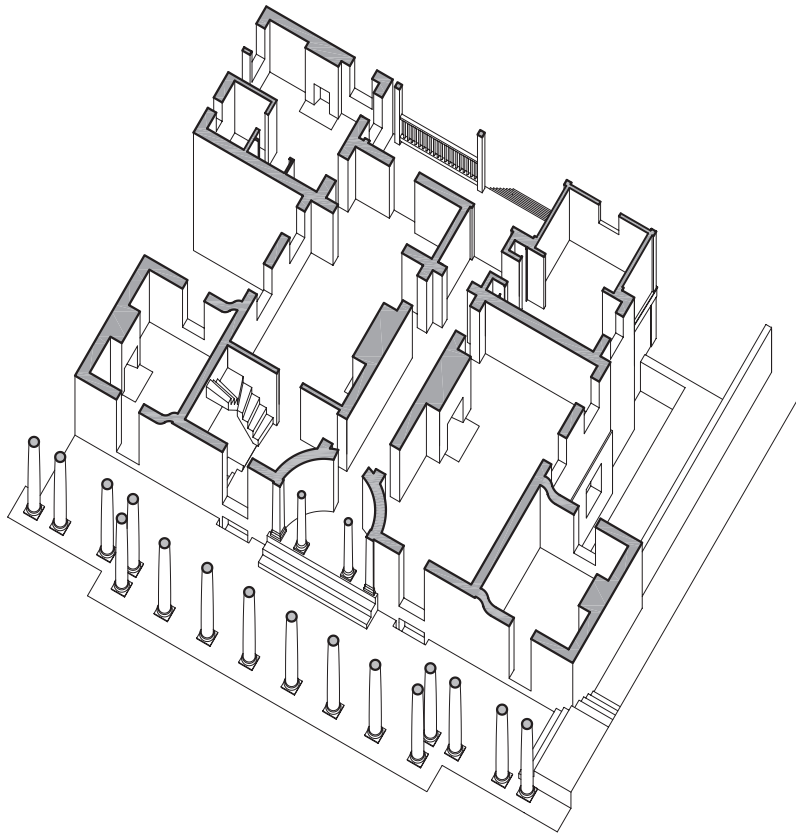

FIRST FLOOR

The first floor plan of Pavilion IX is similar to that of Pavilion I (1822) and Pavilion V (1821), with the exception of the large, recessed entrance niche—a distinctive feature unique to this pavilion, and not seen in any of Jefferson’s other architectural designs.

As originally completed in 1822, the plan of the first floor followed Jefferson’s 1819 floor plan, with only a few exceptions. The primary difference was the configuration of the stairway in the southeast stair hall (104). Jefferson confined his stair to the southwest corner of the hall, and included eight winders to change the direction of the stair. As actually constructed, the stair fills the south end of the hall and is arranged in three runs joined by winders, resulting in a stair that is much easier to use. The original doorways that open to the dining room (103) and the lecture room (102) at the far west end of the central hall are not shown on Jefferson’s plan.

PAVILION IX

As originally planned and used, the first floor had a long, wide, central hall that extended from the front door to the rear of the pavilion. This passage served both the professor in residence and the students. The large lecture room was located to the north of the entrance hall. A doorway in the south wall of the hall opened to the stair hall, and that space, in turn, opened into a large dining room. These two rooms formed the professor's private domain on the first floor. Additional rooms intended for the professor's private quarters included the basement kitchen and related service areas and the second floor parlor and bedchambers.

Jefferson's plan for the pavilion was compact and well-conceived, but did not prove practical for a married professor with a family. By 1829, Professor Tucker, the first occupant, required additional space, and by 1831 an addition had been constructed across the west facade of the pavilion. The first floor level of the addition added a large alcove to the dining room and a new rear entrance vestibule, with additional space west of the lecture room.

Later in the nineteenth century, probably for Professor McGuffey, a large, three-level covered porch was constructed across the rear facade of the 1831 addition, providing additional space to the first floor plan.

Sometime between 1896 and 1900, a large room was constructed at the southwest corner of the pavilion for Professor Peters. The twentieth century brought additional changes to the first floor plan, with the insertion of a bathroom in the southwest room and the expansion of the kitchen onto the north end of the rear porch.

ARCHITECTURAL DESCRIPTION

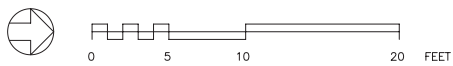
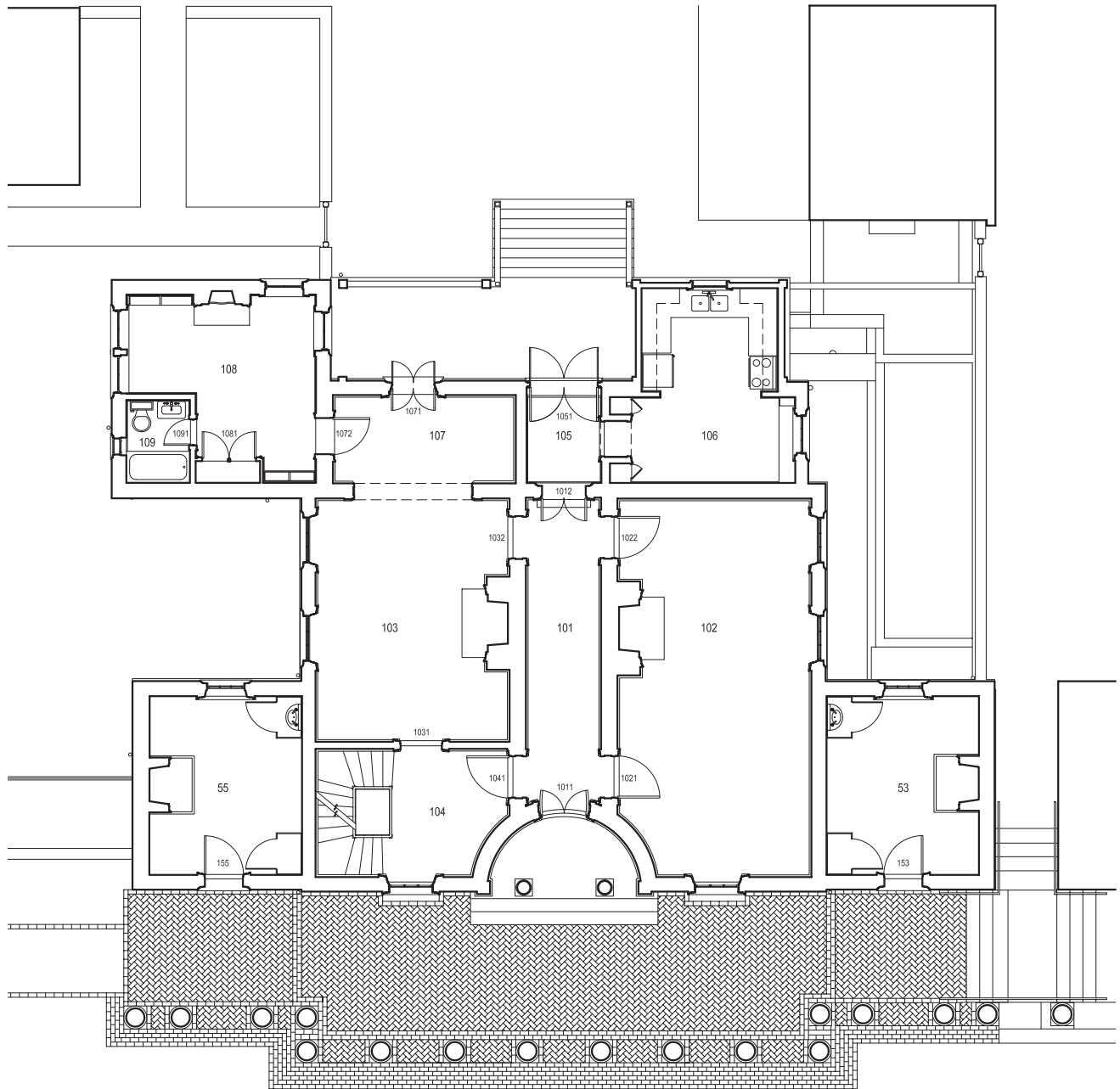

First floor plan

PAVILION IX

ROOM 101 ENTRANCE HALL

The entrance hall extends east to west, fully through the original pavilion. The 5' 9" by 23' 8" hall includes entrances in the east and west walls and two doors each in the north and south walls. The slight curve of the east wall and the curve of the east doors reflect the distinctive curved entrance niche. These curved doors have never been removed from the opening. Although the rear door includes a transom, the construction of the west addition in the nineteenth century considerably reduced the natural light that originally entered the hall.

Floor: Original random-width (5" to 5 $\frac{5}{8}$ " wide) tongue-and-groove boards are laid east/west. Two small, square patches at the east end of the north wall mark the location of a former radiator's piping.

Walls: All four walls are plaster on original masonry. The slight curve of the east wall reflects the recessed niche of the main entrance.

Ceiling: The original plaster-on-lath ceiling is 9' 10 $\frac{3}{4}$ " above the floor.

Baseboard: The original 8 $\frac{1}{2}$ " high baseboard includes a 6 $\frac{1}{2}$ " high splashboard with a 2" molded top (Type B-1).

Doors: The hall includes six original doorways with deep paneled reveals and two-fascia wood architraves (Type T-2), 7 $\frac{1}{2}$ " wide at the east entrance and 6 $\frac{3}{4}$ " wide at the other openings. The head of the architrave on the east doorway is curved to follow the curve of the wall. Above the west doorway, an original rectangular transom is fitted with a fixed twenty-seven-light fanlight.

No. 1011: The east entrance is fitted with an original pair of curved stile-and-rail leaves, each 1' 10" wide by 7' 1 $\frac{3}{4}$ " high by 1 $\frac{3}{4}$ " thick with three raised panels (Type D-1). The untouched original screws securing the hinges indicate that this pair of doors has never been removed from the opening. Hardware: Door hardware includes an original pair of 5" iron butt hinges with original screws on each leaf and vertical slide bolts on the bottom rails. The mortises for bolts remain in the lintel, but the slide bolts have been removed from the upper rails. The north leaf has a later 3 $\frac{3}{4}$ " by 5 $\frac{7}{8}$ " iron rim lock with two brass knobs and a brass keyhole escutcheon plate (type B) on the exterior face (the moveable cover plate is missing); there is the outline for a larger, possibly original rim lock of the type that wrapped around the edge of the door. Also on the north leaf, there is a later 5 $\frac{1}{2}$ " high mortise lockset with a brass knob on the interior face and a *Corbin*

deadbolt on the exterior face; and a brass slide bolt. A recent oval plate on the exterior face is inscribed "Pavilion IX, Van Lengen-Welty." The keeper for the current rim lock is affixed to a wood Dutchman repair on the edge of the south leaf.

No. 1012: The west doorway is fitted with an original pair of 1' 9 $\frac{1}{4}$ " wide by 6' 11 $\frac{3}{4}$ " high by 1 $\frac{3}{4}$ " thick door leaves, each with three raised panels (Type D-2). Hardware: Each door has a recent pair of 4" iron butt hinges. On the south leaf there is a later 5 $\frac{3}{8}$ " high brass mortise lockset with brass knobs and a brass keyhole escutcheon with cover (type A). The original 5 $\frac{1}{2}$ " high iron mortise lock, still in place below the current lock, has been painted over. Evidence for the knob and the outline of a type A escutcheon can be seen on the east face of the door. Hooks-and-eyes hold the leaves open; one is recent, and the other appears to be much older.

Heating: Patches in the flooring near the north wall indicate the former location of a radiator.

Lighting/electrical: A recent reproduction glass lantern is suspended from the ceiling. Other electrical elements include a dimmer switch on the north wall and a duplex receptacle in the south wall.

Finishes investigation: The Kutney finishes analysis recorded the following conditions. A sample from the wall in the northwest corner revealed some twenty-one layers of finish. The earliest was a whitewash applied directly to the white plaster. One sample shows evidence of a size and paper with coarse fibers, probably a wallpaper. The walls should be carefully probed for paste residue or additional paper fibers from wallpaper; the top surface of the door trim is a place where wallpaper fragments sometimes survive. The remarkable "block" pattern paper found in the basement kitchen (B07) is a design typically placed in entrance and stair halls, and may have been used here.

The baseboard is composed of two surfaces: the cap, which retains evidence for an original cream [yellowish white] paint that matches Munsell 2.5Y 8.5/2; and the flat portion, first finished in a red [red brown] paint matched to Munsell 10R 3/4.

The door trim, based on samples from the west doorway, retains nine layers of a cream [yellowish white] paints as the earliest layers, with a total of 20-22 finishes. The earliest finish matches to Munsell 2.5Y 8.5/2.

The first two finishes found on the doors are graining. The front door retained evidence for thirty-two layers of finish, including the initial

ARCHITECTURAL DESCRIPTION

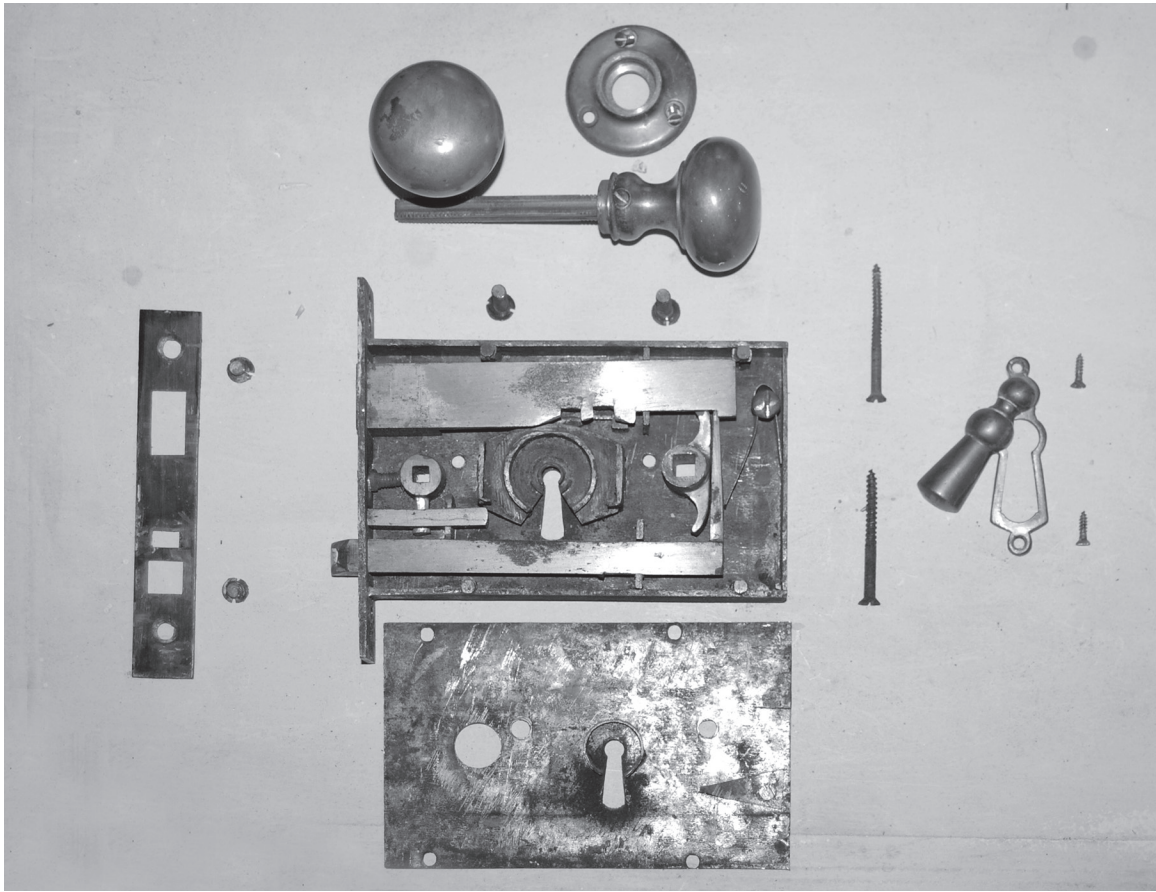

Dismantled original mortise lock from door no. 1041 (between rooms 101 and 104)

PAVILION IX



Rim lock on east entrance door (no. 1011)



*Door no. 2051 (between rooms 201 and 205),
with keyhole escutcheon type A*



*South face of door no. 2051 (between 201 and
205), with keyhole escutcheon type B*



*North face of door no. 1021 (between rooms 101
and 102), with keyhole escutcheon type C*

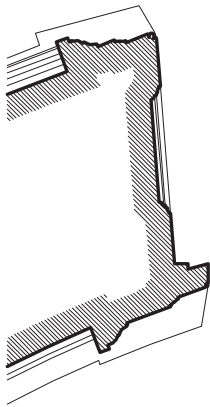

ORIGINAL DOOR CASING AT
DOOR NO. 1011 (T-1)



TYPICAL ORIGINAL INTERIOR
DOOR CASING (T-2)

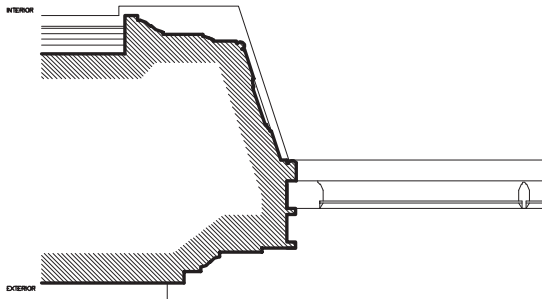

TYPICAL ORIGINAL WINDOW CASING (T-3)

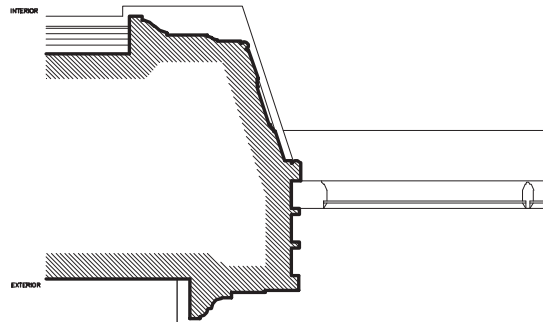

TYPICAL ORIGINAL TRIPLE-HUNG WINDOW CASING (T-4)

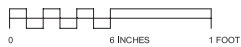

PAVILION IX



Room 102 (original lecture room), looking east

two graining layers, an intermediate grained surface, and the current graining. The earliest graining appears to be a faux mahogany finish.

ROOM 102 DINING ROOM (FORMER LECTURE ROOM)

Currently the largest room in the house, this space, once the professor's lecture room, now functions as the dining room. The long, rectangular space, 14' 10½" by 29' 0", includes two doors in the south wall flanking a wide chimney breast and fireplace; two windows in the north wall; and a single window in the east wall. An original window was removed from the west wall at an undetermined date. The plan generally follows the 1819 Jefferson floor plan, except that the southwest doorway is not shown.

Floor: Random-width (4⅞" to 6" wide) tongue-and-groove boards are laid east/west. These boards are twentieth-century replacements. The original

floor probably became very worn when the room functioned as a classroom. The underside of the flooring, visible in basement room B05, reveals the recent origin of the wood.

Walls: All four walls and the curved southeast corner wall are plaster on original masonry. The original window opening in the west wall is covered in plaster on expanded metal lath.

Ceiling: The original plaster-on-lath ceiling is 9' 11¼" above floor.

Baseboard: The original 8½" high baseboard includes a 6½" high splashboard with a 2" molded top (Type B-1). The base along the west wall may be a replacement dating to the removal of the window, since there is no evidence for the window recess in the baseboard surface.

Doors: The two original doorways in the south wall have two-fascia wood architraves (Type T-2).

Nos. 1021 and 1022: Each opening has an original stile-and-rail door (3' 2½" wide by 6' 11⅞" high by 1¾" thick) with six raised panels (Type D-3).

ARCHITECTURAL DESCRIPTION



Room 102 (original lecture room), looking west

Hardware: Door hardware on each door includes an original pair of 5" high iron butt hinges, and an original 5¼" high brass and iron mortise lockset with a pair of later brass knobs and keyhole escutcheons with covers (types B and C on 1021 and type C on 1022). The brass cover plate is missing from the 1021 lock. Evidence on the jambs reveals that the swing was changed at both doors; originally, the doors opened towards the chimney breast. The mortise locks were turned upside down at the time of the change.

Windows: The original window opening in the east wall, and the two original openings in the north wall have two-fascia wood architraves (Type T-3) that terminate at splashboard-height plinths. At the north windows, the architraves frame splayed, paneled reveals at the sides and head and paneled aprons. The finishes investigation of the northwest window's apron revealed only five paint finishes on what appears to be new wood, indicating that this surface may be a recent replacement. The original

6/6 double rope-hung sash have 12" by 16" panes, ¾" muntins, and recent brass sweep thumb latches on the meeting rails.

The east window has similar paneled reveals. The opening, extending down to the floor, is fitted with an original 6/6/6 triple rope-hung sash with 12" by 18" panes, ¾" muntins, and a recent brass sweep thumb latch on each of the meeting rails.

A fourth original opening was centered in the west wall. It was similar to the north windows. The trim is currently stored in the attic.

Fireplace: The original 7' 2½" wide brick chimney breast projects 1' 9" from the south wall. The brick-lined firebox (3' 0" high by 3' 7" wide) and the stuccoed surround are painted black. The surround is bordered by an 8¾" wide three-fascia wood architrave. Above the architrave is a plain 6½" high wood frieze and a 7½" high denticulated cornice forming a shelf. The mantelpiece is 5' 3½" high.

The 4' 9" wide hearth, projecting 1' 9¾" from the surround, is made up of 3½" by 8" brick pav-

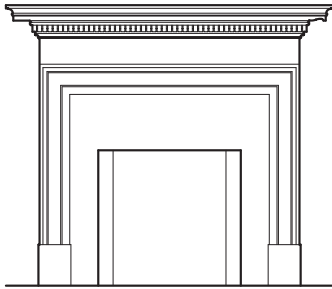

ROOM 205 MANTEL

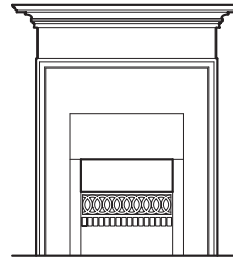
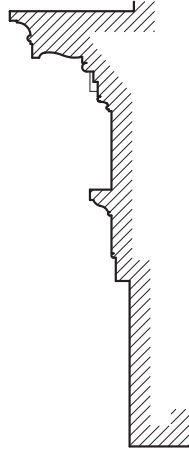

ROOMS 203 AND 204 MANTEL

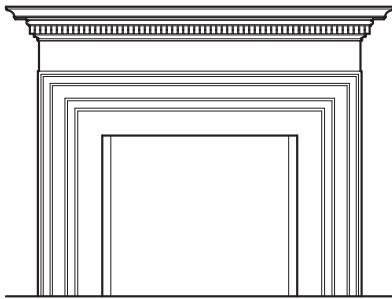
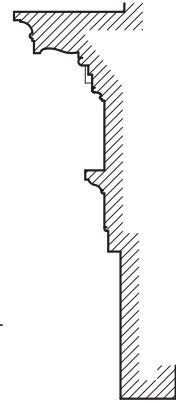

ROOMS 102 AND 103 MANTEL

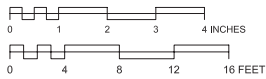
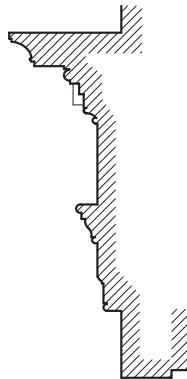

ARCHITECTURAL DESCRIPTION

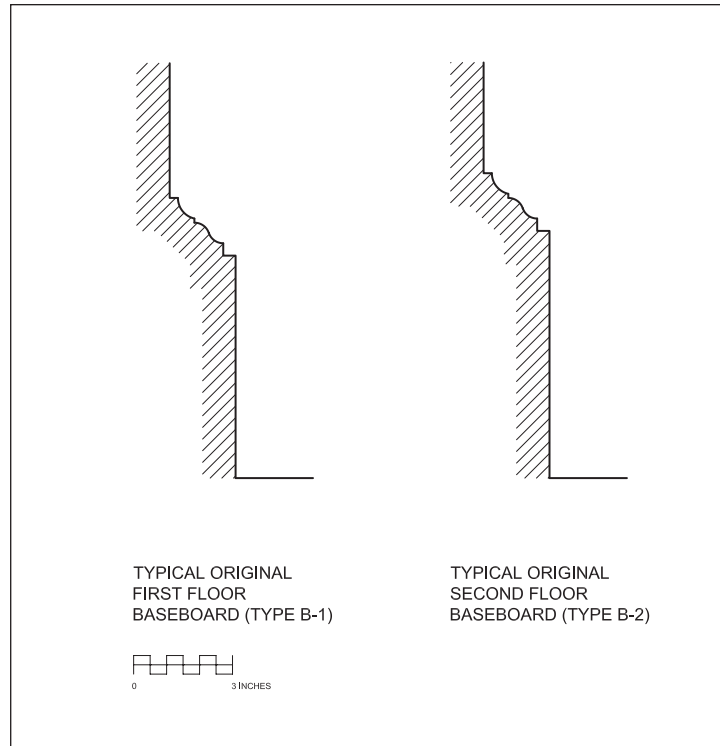

Original baseboard profiles

ers. Three-inch-wide boards border the two ends of the hearth.

Heating: A three-column, ten-section, cast-iron hot water radiator is positioned near the northwest window.

Lighting/electrical: The room is lit by small halogen spotlights on a rod suspended from the ceiling. Other electrical elements include a switch near door 1021; duplex receptacles in all four walls; and a receptacle on the west face of the chimney breast.

Finishes Investigation: In the Kutney finishes analysis, the earliest finishes on the plaster walls are layers of a tan paint. These ten layers are covered in a fairly recent skim coat of plaster. The closest color match to the initial tan finish is Munsell 10YR 7/4.

The architrave of the northeast window retains some 22 to 23 layers of finishes. The earliest is a cream [yellowish white] paint. In contrast, the southwest door architrave includes fifteen layers the earliest of which is a tan. The match to the initial cream paint ranges from Munsell 2.5Y 8/4

to 2.5Y 7/4.

The flat portion of the baseboard was first finished in a red [red brown] paint matched to Munsell 10R 3/4.

ROOM 103 LIVING ROOM

This 14' 10½" by 18' 8" room, currently used as the living room, includes single doorways in the east and north walls, a broad arched opening filling the west wall, two windows in the south wall, and a chimney breast and fireplace centered on the north wall.

Jefferson's 1819 floor plan of this room shows a window in the west wall but no doorway in the north wall. The room was to serve as the professor's dining room, with the kitchen directly below in the basement.

The west archway dates stylistically to the second quarter of the nineteenth century, and is contemporary with the circa 1831 addition.

PAVILION IX



Room 103, looking northwest

Floor: Original, random-width (4" to 6 $\frac{1}{8}$ " wide) tongue-and-groove boards are laid east/west. The boards end at the west archway; the floor west of the archway (in room 107) is contemporary with the addition.

Walls: The north, south, and west walls are original plaster on masonry. The original wood-framed east wall is finished with plaster on lath.

Ceiling: The original plaster-on-lath ceiling is 9' 10 $\frac{1}{2}$ " above the floor.

Baseboard: The original 8 $\frac{1}{2}$ " high baseboard includes a 6 $\frac{1}{2}$ " high splashboard with a 2" molded top (Type B-1).

Doors: The original single doorways in the north and east walls have two-fascia wood architraves (Type T-2). Both of the wood thresholds are very worn.

The circa 1831 archway in the west wall replaced an original window when the west addition was constructed. The 9" wide architrave includes a

symmetrical beaded molding and a small fascia, trimmed with a corner bead. The architrave extends up to a wood key ornamented with an oval bullseye. Bullseye blocks mark the spring line of the arch. At its highest point, the arch is 8' 3 $\frac{1}{2}$ " above the floor.

No. 1031: There is no door in this opening. Marks for a pair of 5" butt hinges on the north jamb, and a keeper on the south jamb, indicate that the door opened into room 103.

No. 1032: There is no door in this opening. Marks for a pair of 5" butts on the east jamb, and a keeper on the west jamb, indicate that the door opened into room 103.

Windows: The two original openings in the south wall have two-fascia wood architraves (Type T-3) that terminate at splashboard-height plinths. The architraves frame splayed, paneled reveals at the sides and head and a paneled apron. The original 6/6 double rope-hung sash have 12" by 16" panes, $\frac{3}{4}$ " muntins, and recent sweep thumb latches on

ARCHITECTURAL DESCRIPTION



Room 103, looking southeast

the meeting rails.

An original window opening in the west wall was replaced by the archway when the circa 1831 addition was constructed. The architrave was reused to create the opening in the west wall of room 107.

Fireplace: The original 7' 1 $\frac{3}{4}$ " wide brick chimney breast projects 1' 9" from the north wall. The brick-lined firebox and the stuccoed surround are painted black. The surround is bordered by an 8 $\frac{3}{4}$ " wide three-fascia architrave. Above the architrave is a plain 6 $\frac{1}{2}$ " high frieze and a 7 $\frac{1}{2}$ " high denticulated cornice. The mantel is similar to the mantel in room 102.

The 5' 3" wide hearth, projecting 1' 11" from the surround, is made up of 3 $\frac{1}{2}$ " by 8" brick pavers. A 3" wide wood board frames the edges of the hearth.

Heating: A three-column, nine-section, cast-iron hot water radiator is positioned near the southwest window. There is a thermostat on the east wall.

Lighting/electrical: Electrical elements include a plate for a ceiling fixture; duplex receptacles in the south and east walls; and receptacles in the east and west faces of the chimney breast.

Finishes investigation: The Kutney finishes analysis noted that samples from the wall near the west arch revealed only twelve finishes; the first five were a tan color like that found in the former lecture room (102). This color matches to Munsell 10YR 7/4.

The sample that best defined the original trim color was found on the apron panel below the southwest window. There were three to four initial cream [yellowish white] layers; the earliest matches to Munsell range 2.5Y 8/4–2.5Y 7/4.

The flat portion of the baseboard retains evidence for the same red [red brown] finish found in other rooms (Munsell 10R 3/4).

The plaster ceiling retains thirteen to fifteen layers. The first five are a cream [yellowish white]

PAVILION IX



Room 104 (stair hall)

to tan in color. The first finish matches Munsell 10YR 8/4.

ROOM 104 STAIR HALL

This compact hall houses the staircase that is continuous from the basement to the second floor. The 14' 10½" by 9' 10" room includes single doors in the north and west walls, and a large window in the east wall. The stair, in three runs, fills the south end of the space. A curved wall protrudes into the northeast corner of the hall.

The existing plan corresponds to Jefferson's 1819 floor plan except for the layout of the stairway. Jefferson shows the stair with two runs and a full component of winders. The physical and finish investigations for this report confirm that the existing stair is in its original form as completed in 1822.

Floor: Original random-width (3¾" to 6" wide) tongue-and-groove boards are laid east/west.

Walls: The north, south, and west walls are finished with plaster on original masonry. The curved northeast wall reflects the curved recess housing the main entrance. The original wood-framed west wall is finished with plaster on lath.

Ceiling: The original plaster-on-lath ceiling is 9' 10¼" above floor.

Baseboard: The original 8½" high baseboard includes a 6½" high splashboard with a 2" molded top (Type B-1).

Doors: The original single doorways in the north and west walls have 6¾" wide two-fascia wood architraves (Type T-2).

No. 1041: The original 3' 2⅝" wide by 6' 11" high by 1¾" thick stile-and-rail door has six raised panels (Type D-3). Hardware: Door hardware includes

ARCHITECTURAL DESCRIPTION



Room 104 (stair hall), looking southeast



Room 105 (rear vestibule), looking east

an original pair of 5" iron butt hinges, and an original brass and iron 5½" high mortise lockset with twentieth-century brass knobs and brass keyhole escutcheons with covers (type A). This is one of six similar original mortise locks remaining in the pavilion. The exposed 5¼" by ⅞" brass face plate covers the concealed sheet-iron lock. The body of the sheet-iron lock is 5¾" by 3⅝" and ⅝" thick. There is evidence for a later small (2¾" by 3¾") rim lock on the north face of the door, above the key escutcheon.

Windows: The original window opening in the east wall has a 7½" wide two-fascia wood architrave (Type T-4) that terminates at splashboard-height plinths. The architrave frames splayed, paneled reveals at the sides and head. The opening, extending down to the floor, is fitted with the original 6/6/6 triple rope-hung sash with 12" by 18" panes, ¾"

muntins, and an old iron sweep thumb latch on each of the meeting rails.

Stair: The original open-string stair begins with five risers ascending south to a landing, then six risers east to a landing, and five risers north to the second floor. The treads are angled, slightly radiating out from the center. The stained, varnished, bullnosed treads range from 10" deep at the interior edge to 1' 1" deep along the exterior edge. The 8¼" high risers (including a 1" nosing) are trimmed with a small cavetto molding beneath the nosing. The string brackets are stylized "C"-scrolls.

The 2½" wide by 2" high mahogany handrail is supported by rectangular ¾" by 1" balusters, spaced 2⅞" to 3¼" apart (three per tread). It rests on tapered, column-like newel posts (3" square and 3' 1¾" high) positioned at the beginning and end of each stair run. At the base of the stair, the

PAVILION IX

balustrade extends to the east to enclose the basement stairwell and then continues down the basement stair run.

Lighting/electrical: A recent sconce is mounted to the west wall. Other electrical elements include switches in the east and west walls and a duplex receptacle in the west wall.

Equipment: There is a telephone receptacle on the east wall.

Furnishings and fittings: Before March 2010, a small brushed steel table was attached to the east wall, north of the window.

Finishes Investigation: The Kutney finishes analysis noted that the curved plaster wall may retain evidence of the earliest finishes. The first layer appears to be a whitewash, followed by a translucent to almost clear, dark amber color surface. This second layer matches to Munsell 2.5Y 7/4.

The earliest finish on the trim, found on the stair fascia, the newel post, and the window sash and architrave, is tan that matches to Munsell 2.5Y 7/4 (the same color found as the second layer on the plaster wall surface).

The flat portion of the baseboard retains evidence for the same red [red brown] found on the baseboard surface in other rooms. It matches to Munsell 10R 3/4.

The ceiling surface beneath the stair retains six initial layers that appear to be whitewashes. The earliest layer matches to a Munsell range between 5Y 8/1 and 5Y 9/1.

ROOM 105 WEST VESTIBULE

The small, 5' 9" by 7' 4" rear entry vestibule includes doorways in the north, east, and west walls. The east doorway, with its pair of doors and rectangular transom, is the original rear entrance of the 1822 pavilion. This space and the flanking rooms, 106 and 107, make up the addition added to the original pavilion circa 1831. The Bohn lithograph from 1856 records the three-story addition and shows a window in the location of the current west entrance, but the arched opening seems to be the original condition and may not have included doors until the twentieth century.

Probes carried out in April 2010 revealed that this vestibule and the east half of the adjacent kitchen (106) were a single space that was open to the exterior through the arched opening in the west wall. The exposed brick wall surfaces in this semi-exterior area were painted. Further investigation

is needed to determine if the nineteenth-century bathroom was housed in the original area north of the current vestibule.

Floor: Original, random-width (4¾" to 5" wide) tongue-and-groove boards are laid east/west. This surface is slightly lower than the hall (101) floor to the east.

Walls: The east wall is the original exterior brick wall of the pavilion. The west and south brick walls are part of the circa 1831 addition. The north frame partition may date to the time of the kitchen expansion, sometime between 1963 and 1978. All four walls are currently finished with plaster, but probes may reveal that there is paint on the brick surfaces beneath the plaster.

Ceiling: The original plaster-on-lath ceiling is 10' 5" above floor.

Baseboard: There is no baseboard, but the walls are trimmed with a quarter-round shoe molding.

Doors: There are three doorways in this vestibule: the original rear entrance to the pavilion in the east wall; a recent north doorway leading to the kitchen; and the arched entrance in the west wall. When the archway was originally built, it may not have had doors or a transom.

The circa 1822 east opening is framed by a 6¼" wide two-fascia architrave. A 2¾" high molded lintel extends across the top of the doorway; above the lintel is an original rectangular transom fitted with a twenty-seven-light transom. Until the west addition was constructed, this entire assembly, including the doors, was an exterior feature.

The current west entrance has a plain fascia casing, and is topped by an arched transom with a six-light fanlight. As originally constructed, the arched opening did not include doors or a transom, and opened to the exterior. A 6¼" two-fascia architrave frames the recent north doorway; there never was a door in the opening. The deep reveal is faced with recessed panels that conceal built-in cabinets accessed from the kitchen.

No. 1051: Pair of twentieth-century stile-and-rail leaves, each 2' 8" wide by 6' 3" high by 2" thick with four horizontal lights. Hardware: Door hardware includes a pair of 3½" high iron butt hinges on each leaf. On the south leaf there is a 7¾" polished brass mortise lockset with a turnkey on the interior face and a key cylinder on the exterior face; and a 2¼" high mortise lockset with narrow, polished brass plates and oval knobs. The north leaf has slide bolts on the top and bottom rails.

A pair of recent screened doors on the exterior

ARCHITECTURAL DESCRIPTION



Room 105 (rear vestibule), looking west



Room 106 (kitchen, looking northwest)

have wood knobs and a closer.

Heating: A three-column, ten-section, cast-iron hot water radiator is positioned near the south wall.

Lighting/electrical: A recent, opal glass, globe fixture is suspended from the ceiling. Other electrical elements include a dimmer switch and two tumbler switches on the north wall.

Furnishings and fittings: Two recent wood coat rails with wood pegs are mounted to the west end of the south wall.

Finishes investigation: No samples were analyzed from this space.

ROOM 106 KITCHEN

The kitchen is in two adjoining areas. The 14' 2½" by 6' 7" east section is in the circa 1831 brick addition added to the original pavilion. During the occupancy of Professor Harris in 1963–1977, the

room was expanded west onto the rear porch. The enlarged kitchen space was renovated circa 1987 under the direction of James Murray Howard.

How the smaller room functioned in the nineteenth century is unknown, but probes carried out in April 2010 revealed that the brick surfaces were painted, with no evidence of an early plaster finish. There was no separation between the original room 106 and the vestibule (105); they formed a single, long narrow space with direct connection to the exterior through the tall arched opening in the west wall of room 105.

Floor: The kitchen floor is covered with 1' 0" square cork tiles.

Walls: In the east section of the kitchen, the walls are brick masonry, finished with recent plaster on expanded metal lath. The west section, built out into the rear porch, is enclosed with wood-framed partitions finished with plaster/gypsum board. The

PAVILION IX

4' 5" wide opening formerly in the center of the east wall (an original 1822 pavilion window opening) is filled in with plaster on expanded metal lath.

Ceiling: The ceiling is 9' 9" above the floor. In the east section, the ceiling is plaster on metal lath. The west ceiling is gypsum board.

Baseboard: The recent 4¾" high baseboard is made up of a splash trimmed with a flush bead at the top.

Door: A 6¼" two-fascia architrave frames the south doorway; there is no door in that opening. The deep reveal is faced with recessed panels encasing flanking built-in cabinets.

Windows: The north opening was inserted at an undetermined date, possibly in the twentieth century. The window is framed by a 6½" wide two-fascia wood architrave and sits above a 6" high two-fascia sill. The 6/6 rope-hung wood sash has 10" by 12" panes, ⅞" muntins, and a brass sweep thumb latch on the meeting rails.

The more recent west window opening, contemporary with the 1963–1978 kitchen expansion, has a 6¼" wide two-fascia wood architrave, and sits above a 6" high two-fascia sill. The 6/6 wood sash slides on weatherstripping tracks, and has 9" by 12" panes, ⅝" muntins, a sweep thumb latch on the meeting rails, and a sash pull on the bottom rail.

Heating: A six-column, twenty-six-section, cast-iron hot water radiator is positioned near the north window.

Lighting/electrical: Two recent, "school house" type fixtures are chain-hung from the ceiling. Other electrical elements include duplex receptacles on the north, south, and west walls of the west section; switches on the north and south walls of the west section; and a simplex outlet under the north window (for an air conditioner).

Plumbing: There is an integral two-basin sink in the solid surface counter top below the west window.

Furnishings and fittings: Circa 1983 pine cabinets with solid surface counter tops extend along the north, west, and south walls of the west section. The hinged cabinet doors have small, round wood knobs. In the upper cabinets, the doors are glazed.

A built-in window seat below the north window is set above the radiator.

Tall built-in cabinets flank the south doorway. Above these cabinets are four bays of doors accessing additional storage spaces.

Equipment: Kitchen appliances include a refrigerator on the south wall, and a stove and dish-

washer on the north wall.

Finishes investigation: No samples were analyzed from this space.

ROOM 107

This room at the south end of the circa 1831 west addition serves as an extension of the adjoining, larger room (103). The 1856 Bohn lithograph shows the three-story addition with a small window in the location of the doorway now in the west wall. The 14' by 6' 9" room includes a wide arched opening filling the east wall, a door in the south wall, and a doorway with french doors in the west wall. In the nineteenth century, the adjoining east room served as the dining room, and there is evidence for a possible dumbwaiter in the northeast corner of this space.

Floor: Random-width (4½" to 5¼" wide) tongue-and-groove boards are laid east/west. The floorboards are contemporary with the circa 1831 addition and the creation of the arched opening. A small area of infill boards in the northeast corner may mark the location of the former dumbwaiter.

Walls: All four walls are plaster on brick masonry. The east wall is the original 1822 exterior wall of the pavilion.

Ceiling: The plaster-on-lath ceiling is 10' 2¾" above the floor.

Baseboard: The 8½" high baseboard includes a 6¼" high splashboard with a 2¼" molded cavetto and ogee cap molding. A later quarter-round shoe molding trims the baseboard at the north end of the west wall. Cut marks on the splashboard at 3' 0" and 3' 6" from the northeast corner relate to the floor opening for a possible dumbwaiter.

Doors: There are doorways in the south, east, and west walls. The only trim at the circa 1831 archway in the east wall is a corner bead along the edge of the opening.

The doorway in the west wall, opening to the rear porch, has a 7" wide two-fascia architrave and paneled reveals. The architrave appears to be the trim from the original west window in room 103, reused in this room. The south doorway, created when the southwest wing was constructed in 1896–1906, is framed by a 4¾" wide single-fascia architrave with a bead-and-quirk ogee molding.

No. 1071: Pair of twentieth-century 1' 9" wide by 6' 10" high by 1¾" thick glazed leaves, each with four lights. Wood screened doors on the exterior each have one screened panel. Hardware: Each

ARCHITECTURAL DESCRIPTION



Room 107, looking southwest

door has a pair of 3" iron butt hinges. On the south leaf there is a 5¼" high mortise lockset with brass knobs, a brass keyhole escutcheon with cover on the interior face, and a brass keyhole escutcheon on the exterior face. Vertical slide-bolts are mounted to the bottom and upper rails of both leaves.

No. 1072: The 2' 9½" wide by 6' 9¾" high by 1¼" thick stile-and-rail door has four raised panels. Hardware: Door hardware includes a pair of 4" high iron butt hinges; and a 5½" high mortise lockset with brass knobs and keyhole escutcheons with covers (type B).

Heating: A three-column, nine-section, cast-iron hot water radiator is positioned at the south end of the west wall.

Lighting/electrical: Electrical elements include a switch and duplex receptacles in the east wall.

Furnishings and fittings: The former opening in the floor in the northeast corner may be evidence for a dumbwaiter installed at an undetermined date in the nineteenth century. The use of sawn

wood lath to close up the opening indicates that the dumbwaiter was removed in the late nineteenth or early twentieth century, possibly when the southwest addition was constructed.

Finishes investigation: In the Kutney finishes analysis, the wall sample revealed only four initial cream layers, versus five layers found in the adjacent room (103). None of these samples were matched to Munsell colors.

The door in the south opening displays only one finish: the current faux-grained surface.

ROOM 108

This large room fills the first floor of the southwest addition constructed between 1896 (when it is not shown on a Sanborn map) and 1900 (when it appears in a photograph). The 14' 5" by 14' 6" room includes a pair of windows in the south wall, a window in the west wall, and a doorway and window in the north wall. A shallow chimney

PAVILION IX



A probe in March 2010 revealed the possible location of a dumbwaiter in room 107

breast, with fireplace, is centered on the west wall. Sometime between 1949 and 1962, a bathroom and closet were inserted in the southeast corner of the original room. At that time, the room was occupied by Professor Hench's bedridden mother-in-law. Prior to that modification, a doorway in the south wall opened to a small porch with steps leading to the grounds. The room's original function is not known.

Floor: Wall-to-wall carpet covers the wood floorboards; these boards are exposed in the closet.

Walls: The brick masonry walls are finished with plaster. The north wall is furred out from the masonry. In the southeast corner of the room, a later bathroom (109) is enclosed with wood-framed partitions finished in plaster. Thin partitions create a closet against the east wall, immediately north of the bathroom.

Ceiling: The plaster-on-lath ceiling is 9' 11½" above carpet.

Baseboard: The 7" high baseboard includes a

splash with a flush bead at the top edge and a two-fillet shoe molding.

Doors: The three doorways (one in the north wall; one in the southeast partition enclosing the bathroom; and one to the east closet) are framed with 4¾" wide single-fascia architraves, each with a bead-and-quirk ogee molding. The north doorway includes a deep wood reveal.

No. 1081: Each of the two leaves in the closet opening is 2' 0" wide by 6' 5" high by 1¾" thick, and has two recessed panels. Hardware: Each leaf has a pair of 3½" iron butt hinges and a small brass latch with an oval knob.

Windows: The single window openings in the north and west walls, and the side-by-side openings in the south wall, are framed by 4¾" wide single-fascia architraves, similar to the trim at the doorways. A quarter-round molding trims the outside edges of the window architraves. A 5½" wide mullion separates the two south openings. Each window sits above a 5" high sill that includes a

ARCHITECTURAL DESCRIPTION



Room 108 (southwest addition), looking west

bullnosed sill, a plain fascia, and a flush bead at the bottom edge. The 2/2 double rope-hung sash have 1' 3" wide by 2' 8" high panes, 1" muntins, and brass sweep thumb latches on the meeting rails.

Fireplace: The 4' 4½" wide chimney breast projects 8¾" from the west wall. The firebox is fitted with an ornate cast-iron coal grate from the late nineteenth to early twentieth century. The stuccoed surround is painted black. A 6¾" wide architrave framing the surround replaced the original mantel. Stylistically, the current mantel was designed to match the detailing of the original 1822 pavilion.

The 4' 3" wide by 1' 6" deep hearth, made up of 4" by 8" brick pavers, is partially covered by the carpet.

Heating: There is no heat in this room, but radiators and heating pipes in the basement room below (B11) provide minimal heat for the large room.

Lighting/electrical: Electrical elements include a switch on the north wall and duplex receptacles in the north wall and in the west partition enclosing the bathroom.

Equipment: Communications receptacles are mounted to the north wall.

Closet: The closet is contemporary with the construction of the bathroom (109). In the closet, 3" wide tongue-and-groove floorboards are laid north/south. A quarter-round molding trims the base of the walls. The closet is fitted with a clothes rod and shelf.

Furnishings and fittings: A built-in bookshelf on the west wall extends from the chimney breast to the south wall. The bookshelf, trimmed with a small crown molding, is the same height as the window architrave and includes eight tiers of shelves. The baseboard continues across the unit.

A similar, smaller bookcase at the north end of the east wall has six tiers of shelves.

Finishes investigation: The Kutney finishes analysis revealed that the plaster walls retained eleven layers of finish. The earliest was a tan color that matches to Munsell color between 10R 8/4 and 10R 7/4.

PAVILION IX

The north door architrave retains seventeen layers of finish. The first finish is a grey with very coarse, dark blue pigment that matches to Munsell 5YR 6/1. The earliest finish found on the flat surface of the baseboard is a grayish white that matches to Munsell 5Y 8.5/2.

ROOM 109 BATHROOM

This small 4' 10½" by 6' 4" bathroom was inserted in the southeast corner of room 108 for Professor Hench between 1949 and 1962. As part of the remodeling, an exterior doorway was removed from the south wall; its location is marked by the current small window opening.

Floor: The floor is finished with 1' 0" square cork tiles like those used in the kitchen (106). Removal of the tiles in April 2010 revealed the same narrow floorboards still in place in the closet in room 108.

Walls: The south and east walls are plaster on the brick masonry walls of the southwest addition. The later north and west wood-framed walls are finished in plaster. A 3' 7½" high tile dado of white ceramic tiles and black cap tiles extends along the north, east, and south walls above the bathtub.

Ceiling: The plaster-on-lath ceiling is 10' 1" above the floor.

Baseboard: The 7" high baseboard includes a splash with a flush bead at the top edge and a two-fillet shoe molding (same as the baseboard in room 108).

Door: The north doorway is trimmed with a plain 2½" wide wood casing. A doorway in the

south wall was replaced with a window when the bathroom was constructed.

No. 1091: The 1' 11¾" wide by 6' 5" high by 1¾" thick stile-and-rail door has two recessed panels. Hardware: Door hardware includes a pair of 3½" iron butt hinges; and a 5" high mortise lockset with brass knobs and a keyhole escutcheon with cover (type B) on the north face.

Window: The small south window opening is set in a deep plastered reveal. The three-light casement sash is fitted with 10" by 12" panes and 13/16" muntins; hardware includes a pair of 3" brass butt hinges and a small latch. There is a wood-framed screen on the exterior side of the opening.

This opening is in the location of a former doorway.

Lighting/electrical: The room is lit by a ceiling fixture. Other electrical elements include a switch near the north doorway.

Heating: There is no heat in this room, but the radiators and heating pipes in room B11 below provide minimal heat.

Plumbing: The bathroom is fitted with a cast-iron enameled bathtub on the east wall; an *American Standard* toilet marked "OCT 11 1994" on the west wall; and a vitreous china pedestal lavatory on the west wall.

Furnishings and fittings: A black ceramic soap holder, and a black ceramic towel bar are integrated into the tile dado. There is a metal toilet paper holder on the south wall.

Finishes investigation: No samples were analyzed from this space.

ARCHITECTURAL DESCRIPTION

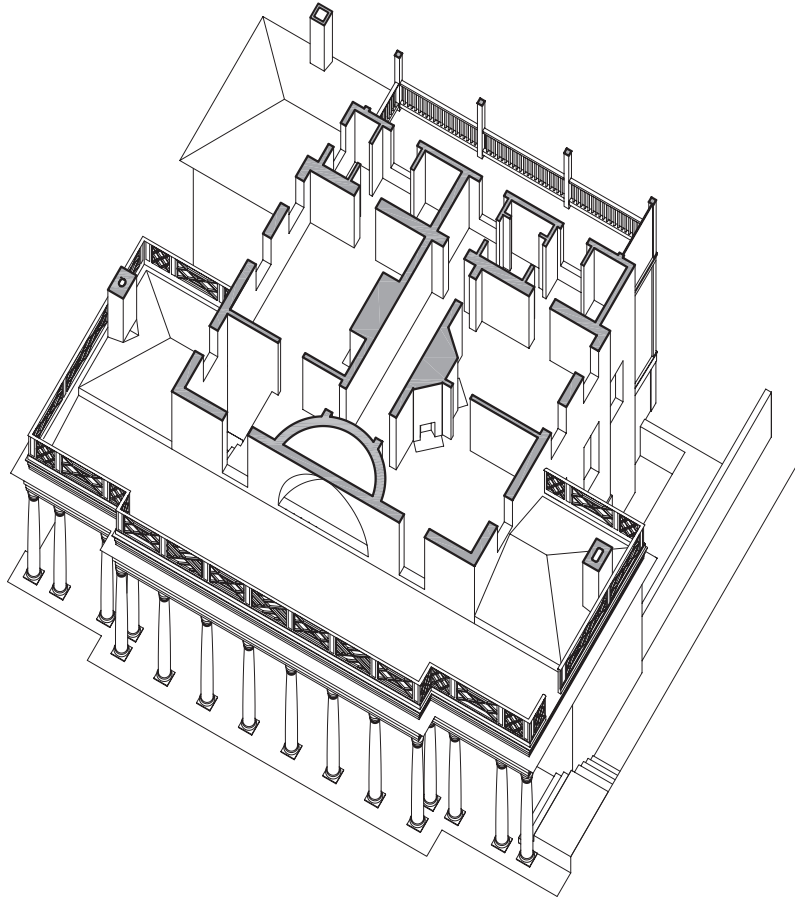

SECOND FLOOR

The second floor of the original pavilion retains most of its historic character. The existing plan duplicates the original Jefferson plan of 1819, with two exceptions: brick chimney masses and fireplaces in each room, where Jefferson shows only Franklin stoves; and no opening at the east end of the central hall. Apparently, each of the three brick fireplaces originally included a stove, as the accounts refer to payments for castings and iron for three stoves as well as “3 stove stones” upon which the stoves were to be positioned. Although Jefferson shows a door or window in the curve of the upper semi-dome of the entrance niche, it would be difficult to have an opening there, due to the geometry of the architecture.

As originally completed, the second floor plan included the stair hall in the southeast corner and, immediately to the west, a large, elegant room that served as the professor’s

PAVILION IX

parlor. A wide central hall, extending from east to west, separated the more public areas from two large bedchambers filling the north end of the plan. All of these high ceilinged rooms had impressive cornices (in contrast to the first floor rooms where there were no cornices) and numerous large windows providing natural light.

Professor Tucker's need for more space led to an addition with narrow rooms constructed at the west facade of the pavilion by 1831. The original windows in the west elevation were modified to create doorways into the addition.

Additional changes were made as the nineteenth century progressed. Professor McGuffey had a three-level porch constructed across the face of the west addition, adding an outdoor terrace to the second floor; a window was converted to a doorway to provide access to the new terrace. At an undetermined date, a doorway was inserted in the partition that separated the two original north bedchambers.

The twentieth century saw the insertion of two bathrooms and closets in the west addition and the relocation of the doorway connecting the two bedchambers.

ARCHITECTURAL DESCRIPTION

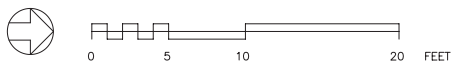
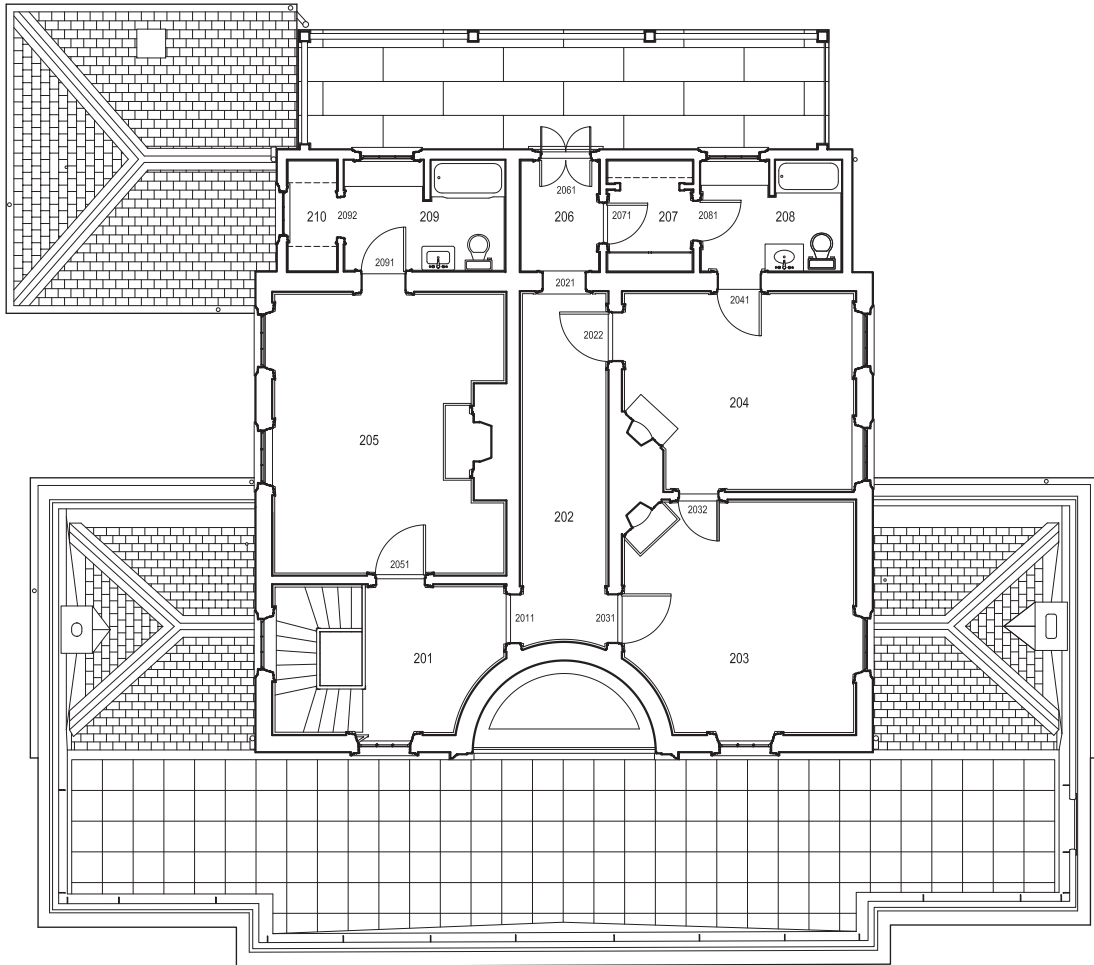

Second floor plan

PAVILION IX



Room 201 (stair hall), looking southeast



Room 202 (hall), looking east

ROOM 201 STAIR HALL

This hall houses the upper terminus of the original staircase. The 15' 3" by 9' 10" hall includes single doorways in the west and north walls and windows in the south and east walls. The east window opens to the terrace. The original stairwell fills the south end of the space.

Jefferson's 1819 floor plan shows all of these features except for the staircase, which he does not draw. The stair is included on the first floor plan but in a configuration that was different than the stair as completed in 1822.

Floor: Original random-width (4" to 5 $\frac{3}{8}$ " wide) tongue-and-groove boards are laid east/west.

Walls: The north, east, and south walls are plaster on original brick masonry. The original wood-framed west partition is finished with plaster.

Ceiling: The original plaster-on-split lath ceiling is 12' 7" above the floor.

Baseboard: The original 9 $\frac{1}{4}$ " high wood baseboard includes a 7 $\frac{1}{4}$ " high splashboard with a 2" molded top (Type B-2).

Cornice: The original 2' 9" high wood entablature is composed of a three-fascia architrave (with the three fasciae separated by beads), a plain frieze, and a denticulated cornice.

Doors: The original single doorways in the north and west walls have 6 $\frac{1}{2}$ " wide two-fascia architraves (Type T-2). Recessed wood panels line the reveal of the north doorway.

No. 2011: There is no door in this opening. Marks for a pair of 5" butt hinges on the west jamb indicate that the door opened to the south, into this space.

Windows: The original window opening in the

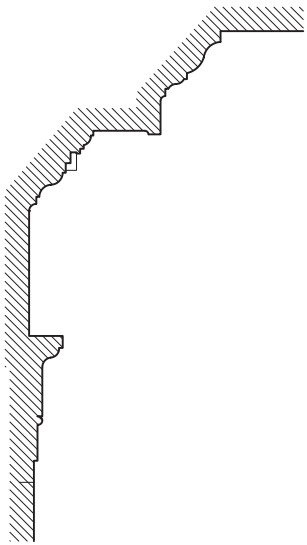

ROOM 201

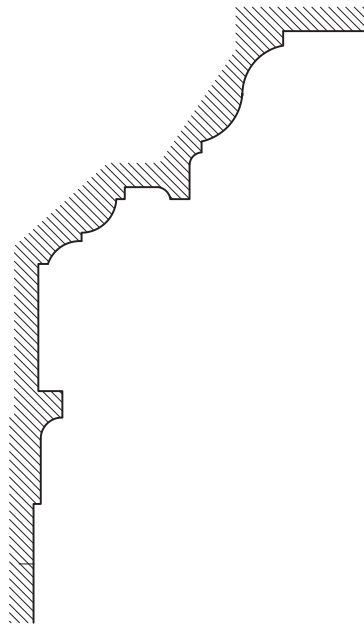

ROOM 202

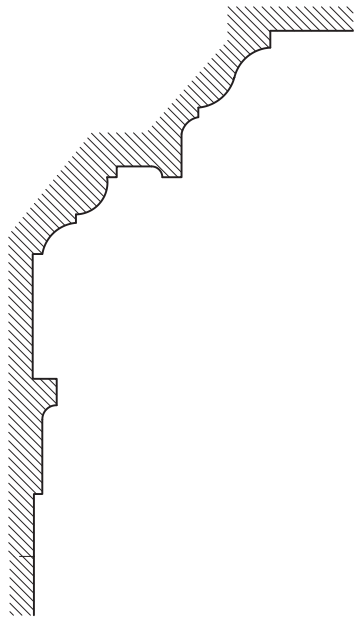

ROOM 203

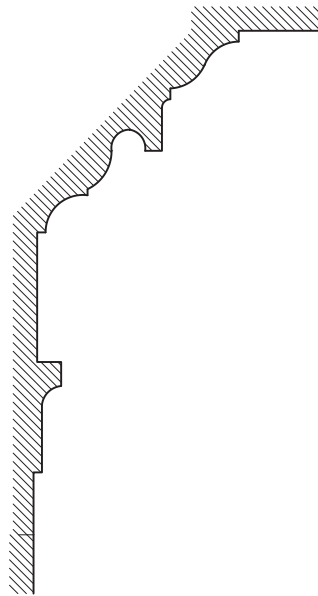

ROOM 204

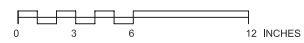

PAVILION IX

east wall has a two-fascia wood architrave (Type T-4) that terminates at splashboard-height plinths. The architrave frames have splayed, paneled reveals at the sides and head. The opening, extending down to the floor, is fitted with the original 6/6/6 triple rope-hung sash with 12" by 18" panes, ¾" muntins, and a recent sweep thumb latch on each of the meeting rails. There are slide bolts on the top rails of the center and lower sashes. A recent wood hand grip extends out from the north reveal along the edge of the stair opening.

The original south window in the stairwell is framed by a 6½" two-fascia wood architrave and has typical paneled reveals that sit above a 3" bull-nosed sill. The original 6/6 double-hung sash has 12" by 18" panes, ¾" muntins, and a sweep thumb-latch on the meeting rails.

Stair: The original stair from the first floor fills the south end of the hall. The stair run ends on the east wall, just south of the window opening. The mahogany handrail, supported by balusters, extends from a 3' 1" high turned newel at the head of the stair across the stair opening to a half-newel on the west wall.

Lighting/electrical: A recent wall sconce is mounted to the west wall. Other electrical elements include a switch on the west wall.

Equipment: There is a communications outlet on the west wall.

Finishes investigation: The Kutney finishes analysis reported on two of the nine samples taken in this room: at the ceiling above the east window, where only recent finishes were found; and the at wall surface above the same window. On the wall, the first four layers included tan or cream, but there is no Munsell match that would permit a comparison to findings in the first floor stair hall (104).

ROOM 202 HALL

The central hall extends east to west through the original 1822 pavilion. The 5' 9½" by 23' 4½" space includes single doorways in the south and west walls and two doorways in the north wall. There are no windows. Jefferson's 1819 floor plan shows a window in the west wall, where there is now a doorway, and in the curved east wall. An opening in the east wall would be unlikely, due to the semi-dome above the recessed main entrance.

Floor: Original random-width (3¾" to 6½" wide) tongue-and-groove boards are laid east/west.

Walls: All four walls are plaster on original masonry. The east wall curves inward.

Ceiling: The original plaster-on-split-lath ceiling is 12' 6" above the floor. The original attic access hatch in the west half of the ceiling is framed with a beaded fascia. The 1' 8" by 2' 5" access cover is made up of beaded tongue-and-groove boards.

Baseboard: The original 9¼" high baseboard includes a 7¼" high splashboard with a 2" molded top (Type B-2).

Cornice: The original 2' 0½" high wood entablature is composed of a two-fascia architrave, a plain frieze, and a projecting cornice.

Doors: The hall includes four doorways. The two north openings and the south doorway have two-fascia wood architraves (Type T-2) and paneled reveals. The later west doorway was created when the west addition was constructed circa 1831. It is framed by a 5" single-fascia architrave composed of an outer quirked ogee molding and a fascia. The Jefferson floor plan shows a window in this position.

No. 2021: There is no door in this opening. Marks for a pair of 3" butt hinges on the south jamb indicate that the door opened to the east, into the hall.

No. 2022: The original 3' 2" wide by 6' 11¾" high by 1¾" thick stile-and-rail door has six raised panels (Type D-3). The door was locked at the time of the investigation. Hardware: Door hardware includes a pair of later 4" iron butt hinges; an original mortise lockset with later brass knobs; and covered brass keyhole escutcheons (type A on the south face, type B on the north face). Evidence visible in room 204 indicates that this door was originally hinged to the east jamb and opened into the bedroom. When the door swing was changed, the original mortise lock was reinstalled upside down. The position of the original keyhole can be seen next to the knob. Currently, the keyhole escutcheons are positioned below the knob, but there are no associated keyhole cutouts in the wood door.

Lighting/electrical: A recent glass lantern is suspended from the ceiling. Other electrical elements include a switch on the south wall, near the south doorway, and a duplex receptacle on the north wall.

Finishes investigation: The Kutney finishes analysis revealed the following conditions. The wall sample did not reveal any early finishes. The wood cornice retained seventeen total layers; the first five are a tan color. The earliest tan matches to Munsell 2.5Y 7/4, the same color found on the trim of the

ARCHITECTURAL DESCRIPTION



Room 203 (bedroom), looking southwest

first floor stair hall (104). The original plaster ceiling survives and retains a complete paint history, including multiple layers of initial whitewashes.

The architrave of the south door retains three finishes of a cream paint. The earliest matches to a color between Munsell 2.5Y 7/4 and 2.5Y 8/4. The typical red [red brown] that matches to Munsell 10R 3/4 was found on the flat surface of the baseboard.

ROOM 203 BEDROOM

This room is one of the two original second-floor bedchambers. The nearly square room, 15' 3" by 15' 4", includes windows in the north and east walls and doorways in the south wall and west partition. An angled chimney breast and fireplace are positioned in the southwest corner. Although Jefferson's floor plan shows a stove instead of a conventional masonry fireplace, the existing fireplace

is an original feature. At an undetermined date, a door was inserted in the center of the west partition. Later, it was moved to its current position near the fireplace.

Floor: Original random-width (4" to 6½" wide) tongue-and-groove boards are laid east/west.

Walls: The north, east, and south walls, the curved southeast corner wall, and the angled southwest chimney mass are original brick masonry. The west wall is an original framed partition. All four walls are finished in plaster. At the location of the former doorway in the west partition, the opening is covered with plaster on expanded metal lath.

Ceiling: The recent plaster-on-expanded-metal-lath ceiling is 12' 7" above the floor. This plaster surface is applied over the original split wood lath surface. These surfaces are visible in the attic.

Baseboard: The original 9¼" high baseboard includes a 7¼" high splashboard with a 2" molded top (Type B-2). A cut in the west base, 3' 11" from

PAVILION IX



Room 203 (bedroom), looking southeast



Room 204 (bedroom), looking southeast

the north wall, indicates the position of the north jamb of the former doorway.

Cornice: The original 2' 2½" high wood entablature is composed of a two-fascia architrave, a plain frieze, and a projecting cornice.

Doors: The single doorways in the south and west walls are framed by 6½" wide two-fascia wood architraves (Type T-2). The south opening is original, but the west doorway is a later insertion in the partition; in the mid-twentieth century, it was moved from an earlier position near the center of the partition.

No. 2031: The original 3' 2¾" wide by 6' 11½" high by 1¾" thick stile-and-rail door has six raised panels (Type D-3). Hardware: Door hardware includes a pair of original 5" high iron butt hinges; a later 5¼" high mortise lockset with brass knobs; and brass keyhole escutcheons with covers (type A on the south face and type B on the north face).

There is evidence on both of the door faces for the locations of the original knobs and escutcheons.

No. 2032: The later 2' 7½" wide by 6' 7" high by 1¾" thick stile-and-rail door has six raised panels (Type D-4). Hardware: Door hardware contemporary with the later door includes a pair of 4" high iron butt hinges; a 5¼" high mortise lockset with brass knobs; and brass keyhole escutcheons with covers (type B).

Windows: The original window openings in the north and east walls have 7½" wide two-fascia architraves (Type T-3 east; T-4 north) that terminate at splashboard-height plinths. At the north window, the architrave includes splayed, paneled reveals at the sides and head and a paneled apron. The original 6/6 double rope-hung sash has 12" by 18" panes, ¾" muntins, and a recent sweep thumb latch on the meeting rails.

The east window has similar paneled reveals.

ARCHITECTURAL DESCRIPTION



Room 204 (bedroom), looking north

The opening extends down to the floor. It is fitted with an original 6/6/6 triple rope-hung sash with 12" by 18" panes, $\frac{3}{4}$ " muntins, and a recent sweep thumb latch on each of the meeting rails. There is a slide bolt on the top rail of the lowest sash.

Fireplace: The original plastered brick chimney breast extends diagonally across the southwest corner of the room. A late nineteenth-century, cast-iron coal grate and frame fill the firebox opening. The original plain wood surround is framed by a $2\frac{1}{4}$ " ogee molding. A $6\frac{3}{4}$ " high frieze and a 5" high cornice support an ogee-edged mantel shelf. The northwest end of the shelf was cut off when the doorway in the west partition was moved to its current position.

The 3' 3" wide brick hearth projects 1' $4\frac{1}{2}$ " from the surround. It is positioned slightly above the level of the floor and is surrounded by a wood frame.

The 1819 Jefferson floor plan shows a stove in the southwest corner of the room, with no chimney breast, but the existing fireplace is the original condition. The fireplace may have included one of the three stoves provided in 1822.

Heating: A three-column, eleven-section, cast-iron hot water radiator is positioned near the north window. An air conditioner sits in the north window.

Lighting/electrical: Electrical elements include duplex receptacles on the north and west walls, and a switch on the curved southeast wall. Gas piping still in place in the attic indicates that a gas ceiling fixture was used in this room in the nineteenth century.

Equipment: A communications cable extends along the base of the curved southeast wall and out through the east window.

Furnishings and fittings: Planned by Jefferson

PAVILION IX

to function as a bedchamber, the bedstead was likely placed against the west partition. At an undetermined date, probably in the early twentieth century, a doorway was inserted in the center of that partition, making the placement of the bed difficult. More recently, the doorway was repositioned next to the chimney breast, thereby creating more wall space.

Finishes investigation: The Kutney finishes analysis looked at several surfaces in this room, but none of the color finishes were matched to the Munsell system.

ROOM 204 BEDROOM

The 15' 3" by 13' 1" original northwest bedchamber includes doorways in the south, east and west walls and two windows in the north wall. An angled chimney breast and fireplace, filling the southeast corner, are original features, although the Jefferson floor plan shows a stove in that location. The west doorway was originally a window. The east doorway is a later insertion.

Floor: Original random-width (4¾" to 6¼" wide) tongue-and-groove boards are laid east/west.

Walls: The north, west, and south walls, and the angled southeast chimney mass are original brick masonry; the east wall is an original framed partition. All four walls are finished in plaster. At the center of the east partition, the later doorway is covered over with plaster on expanded metal lath.

Ceiling: The recent plaster-on-expanded-metal-lath ceiling, 12' 7" above the floor, is applied over the original split lath surface. These surfaces can be seen in the attic.

Baseboard: The original 9¼" high baseboard includes a 7¼" high splashboard with a 2" molded top (Type B-2). A cut in the east base, 4' 0" from the northeast corner, marks the former position of the north jamb of the east doorway.

Cornice: The original 2' 2½" high wood entablature is composed of a two-fascia architrave, a plain frieze, and a cornice.

Doors: The original south doorway is framed by a 6¼" wide two-fascia wood architrave (Type T-2). The west opening, added when the rear addition was constructed in circa 1831, has the same 6¼" wide trim; this may be from the original west window. The later east doorway has a 4¾" wide two-fascia architrave composed of an outer ogee molding, a fascia, an ogee, a fascia, and a bead at

the opening. This trim is unique in the pavilion. Like the trim at the west and south openings, this architrave terminates at baseboard-height plinths, but it is too narrow for the width of the blocks.

No. 2041: The circa 1831 2' 10" wide by 6' 6" high by 1" thick stile-and-rail door has six raised panels. Hardware: The door hardware includes a recent pair of 3" high brass butt hinges; a 4½" by 6" "Carpenter" patent lock, contemporary with the door, with later brass knobs; and an oval brass keyhole escutcheon.

Windows: The two original window openings in the north wall have 6½" wide two-fascia architraves (Type T-3) that sit above 2¾" sills, positioned 3' 0½" above the floor. The original 6/6 double rope-hung sash have 12" by 18" panes, ¾" muntins, and recent sweep thumb latches on the meeting rails.

Fireplace: The original plastered brick chimney breast extends diagonally across the southeast corner of the room. A late-nineteenth-century, cast-iron coal grate fills the firebox opening. The original mantel is similar to the mantel in room 203: a plain wood surround is framed by a 2¼" ogee molding; and a 6¾" high frieze and a 5" high cornice support an ogee-edged mantel shelf. The brick hearth is 3' 3" wide and 1' 3" deep. In 1822, the fireplace opening may have included a cast-iron stove.

Heating: A three-column, eleven-section, cast-iron hot water radiator is positioned near the north-west window.

Lighting/electrical: Electrical elements include duplex receptacles on the north, east, and south walls. Surviving gas pipes in place in the attic indicate that there was a gas ceiling fixture in this room in the nineteenth century.

Furnishings and fittings: Planned as the smaller of the two second floor bedchambers, as originally completed there was no doorway in the east partition. The bedstead could be placed against that wall. Much later, the doorway was inserted in the center of the east partition, leaving no convenient place to position a bedstead. More recently the doorway was moved south to create more free wall area.

Finishes investigation: The Kutney finishes analysis looked at a sample from the south wall where there were seventeen layers revealed. The first three to four layers were tan in color. None of the finish layers were matched to the Munsell system.

ARCHITECTURAL DESCRIPTION



Room 205 (original parlor), looking northeast

ROOM 205 BEDROOM (ORIGINAL PARLOR)

This large, second floor room, the finest space of the original pavilion, was intended to serve as the professor's parlor. The 15' 3" by 18' 6" room includes doorways in the east and west walls, two windows in the south wall, and a handsome chimney breast and fireplace positioned slightly off center on the north wall. Jefferson's 1819 floor plan shows a stove centered on the north wall, with no chimney breast, but the current chimney and mantel are original conditions. Later and most recently, the room functioned as the primary bedroom.

Floor: Original, random-width (3½" to 6" wide), tongue-and-groove boards are laid east/west. Several floorboards near the center of the floor appear to be replacements.

Walls: The north, west, and south walls are original brick masonry; the east wall is an origi-

nal framed partition. All four walls are finished in plaster.

Ceiling: The recent plaster-on-expanded-metal-lath ceiling is 12' 7" above the floor.

Baseboard: The original 9¼" high baseboard includes a 7¼" high splashboard with a 2" molded top (Type B-2).

Cornice: The original 2' 0" high wood Doric entablature is composed of a two-fascia architrave, a frieze with alternating triglyphs and metopes with terra cotta heads, and a denticulated cornice. The heads are additionally ornamented with pairs of cast-lead ribbons secured by small, cut nails. All of this ornament was provided by William Coffee of New York City. The same cornice design, complete with the female head ornaments, can also be found in the former second floor parlor at Pavilion VI.

Doors: The original doorway in the east wall is framed by a 6¼" wide two-fascia wood architrave (Type T-2). The later west doorway (originally a

PAVILION IX



Room 205 (original parlor), looking southwest

window) has a similar architrave, 7¼" wide (Type T-3), that is the original window trim reused. Both architraves terminate at splashboard-height plinths.

No. 2051: The original 3' 2¾" wide by 6' 11¾" high by 1¾" thick stile-and-rail door has six raised panels (Type D-3). Hardware: The door hardware includes a pair of later 4½" iron butt hinges; an original 5½" high mortise lockset with later brass knobs; and covered brass keyhole escutcheons (type A on the east face, type B on the west face).

Windows: The two original window openings in the south wall have two-fascia architraves (Type T-3) that terminate at splashboard-height plinths. In the southwest opening, the architrave frames paneled reveals, head, and a paneled apron. The southeast opening is similar, but recently the apron has been covered to form a plain sill and an apron with a plain recessed panel, flush with the edge of the architrave. The original 6/6 double rope-hung

sash have 12" by 18" panes, ¾" muntins, and recent sweep thumb latches on the meeting rails.

Fireplace: The original 7' 7½" wide plastered brick chimney breast projects 2' 1½" from the north wall. The brick-lined firebox and the stuccoed surround are painted black. The original surround is bordered by a 6¼' wide two-fascia architrave. Above the architrave is a plain 5¼" high frieze and a 6½" high denticulated cornice supporting the mantel shelf, 5' 2" above the floor. In 1822, the fireplace opening may have included a cast-iron stove.

The original 4' 9" wide brick hearth projects 1' 10½" from the surround. The brick surface is positioned slightly above the floor level, and is bordered by a 1¾" wide wood frame.

Heating: A three-column, nine-section, cast-iron hot water radiator is positioned near the southwest window.

Lighting/electrical: Electrical elements include duplex receptacles on the east and west walls, and

ARCHITECTURAL DESCRIPTION

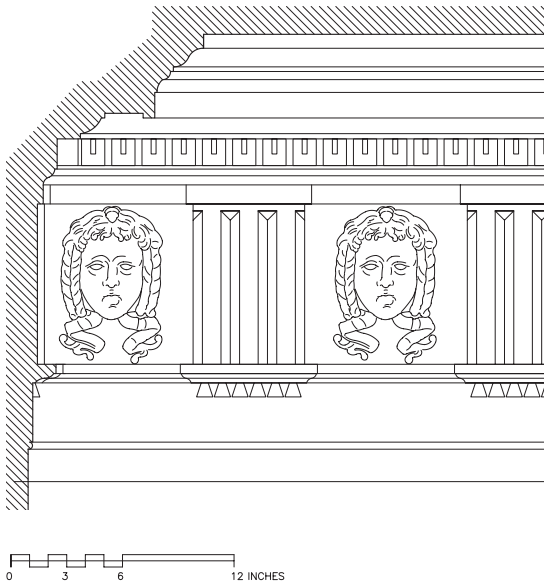

Room 205 (original parlor) cornice

a switch on the east wall. Gas piping remaining in the attic indicates that there may have been a gas ceiling fixture in the room.

Equipment: There is a communications outlet on the apron of the southwest window, and a television cable outlet on the apron of the southeast window.

Finishes investigation: The Kutney finishes analysis revealed the following original finishes. A plaster sample from the south wall had a total of fifteen finish layers; the first six were cream [yellowish white]. The Munsell color match for the first finish is between 2.5Y 7/4 and 2.5Y 8/4.

The wood cornice sample from the frieze surface had a grey primer covered in seven early layers ranging from cream [yellowish white] to tan in color. The color match for the first finish is between Munsell 2.5Y 7/4 and 2.5Y 8/4.

The flat surface of the baseboard retains evidence for a red [red brown] finish that matches to Munsell 10R 3/4. Although the plaster ceiling surface is recent (the plaster is on expanded metal lath), the analysis found fourteen layers. The first six were a cream layer. The earliest cream [yellowish white] matches to Munsell 10YR 8/4.

ROOM 206 VESTIBULE

This vestibule, centered in the circa 1831 west addition, provides access to the west porch. The small, 5' 2½" by 7' 4" room includes doorways in the north, east, and west walls. The east opening was a window prior to the construction of the west addition. The west opening was a window until its conversion into a doorway when the west porch was constructed.

Floor: Random-width (3¾" to 6½" wide) tongue-and-groove boards are laid east/west. The floorboards meet at a seam extending north/south, 1' 6" from the east wall.

Walls: The east wall is the original exterior brick rear wall of the Jefferson pavilion. The south and west walls are contemporary with the west addition. The north wall is a framed partition. All four walls are finished in plaster.

Ceiling: The plaster-on-lath ceiling is 12' 3" above the floor.

Baseboard: The 5½" high baseboard includes a splashboard with a flush bead at the top edge.

Doors: There are doorways in the north, east, and west walls. The east doorway, originally a win-

PAVILION IX



Room 206 (rear vestibule), looking west



Room 207 (closet), looking southeast

dow, is framed by a 5" wide single-fascia architrave with a plain fascia and a plain, beveled, outer molding; a flush bead trims the inner face of the architrave. A ½" filler piece has been added to the south jamb to accommodate the size of the door.

The west doorway, originally a window in the circa 1831 addition, has a 4¾" wide architrave composed of an outer ogee molding, a fascia, and a bead at the opening. Additional trim was added to the architrave to extend it to the floor when it was converted to a doorway to access the porch. Above the opening is a transom with a four-light awning sash; its hardware includes a pair of butt hinges on the top rail and a latch on the bottom rail.

The north doorway is framed by a 6¼" two-fascia architrave.

No. 2061: The opening is fitted with a pair of twentieth-century 1' 9" wide by 6' 11¾" high by 1½" thick glazed leaves, each with four lights. Hardware: Each leaf has a pair of 3" iron lift-off hinges.

On the south leaf there is a 2¼" by 3½" *Corbin* rim lock with brass knobs and a decorative iron keyhole escutcheon on the exterior face. The north leaf has a wood pivot latch. There are slide bolts on both leaves: one on the bottom and above the lock on the south leaf; and one on the bottom and one on the top rail of the north leaf.

Lighting/electrical: A recent "can"-type fixture is suspended from the ceiling.

Finishes investigation: No samples were taken from this area.

ROOM 207 CLOSET

This 5' 8" by 7' 4" walk-in closet, created in the twentieth century when the west addition was remodeled, includes doorways in the north and south walls. A built-in storage unit covers the east wall, and there is a closet on the west wall.

Floor: The later 2¼" wide tongue-and-groove

ARCHITECTURAL DESCRIPTION

boards are laid east/west. They probably cover original west addition flooring, similar to the floor seen in the vestibule (206).

Walls: The east wall is the original exterior brick rear wall of the Jefferson pavilion; the west wall is brick masonry dating to the west addition. The north and south walls are framed partitions. All four walls are finished in plaster.

Ceiling: The plaster-on-lath ceiling is 10' 11" above the floor.

Baseboard: The 6" high baseboard includes a splashboard with a flush bead at the top edge.

Doors: The doorways in the north and south walls have 6¼" wide two-fascia architraves. The recent west doorway, added to create a separate closet, is formed with a 3½" wide fascia trimmed with a bead.

No. 2071: The 2' 8" wide by 6' 7" high by 1½" thick stile-and-rail door has six raised panels. The quirked ogee panel molding on this door differs from the simpler molding on the original doors. Hardware: The door hardware includes a pair of 4" iron butt hinges; a 5¼" mortise lockset with brass knobs; a covered brass keyhole escutcheon (type B) on the south face; and an oval brass escutcheon on the north face.

West door (closet): The recent sliding doors have been removed from this opening. The track remains in place.

Lighting/electrical: The closet is lit by a ceiling fixture with an opal glass pillbox shade. There is a switch on the south wall.

Furnishings and fittings: A recent built-in, four-bay-wide storage unit on the east wall includes an upper cabinet with two pairs of plain doors and a lower cabinet with two tiers of shelving. A small ogee molding trims the top of the unit, and the baseboard extends across the bottom. The doors include small butt hinges and chrome knobs.

The west end of the space is a clothes closet, fitted with a clothes rod and a shelf. An ogee molding, shallower than the molding on the east unit, trims the top.

Finishes investigation: No samples were analyzed from this area.

ROOM 208 BATHROOM

This 9' 2" by 7' 4" bathroom, at the north end of the circa 1831 west addition, includes doorways in the south and east walls and a window in the west wall. The east doorway was formerly a window opening

in the northwest bedchamber of Jefferson's pavilion. The current plan and bathroom fittings date to the twentieth century.

Floor: White 1' 0" square vinyl tiles cover the floor. In April 2010, the tile was removed to reveal a twentieth-century subfloor of crudely laid diagonal boards. The circa 1831 flooring was probably removed to facilitate the installation of plumbing pipes.

Walls: The east wall is the original exterior brick rear wall of the Jefferson pavilion; the west and north walls are brick masonry of the west addition. The south wall is a later framed partition. A framed partition encloses the south end of the bathtub. All four walls are finished in plaster.

Ceiling: The plaster ceiling is 10' 3" above the floor.

Baseboard: The 5¾" high wood baseboard includes a splashboard with a flush bead at the top edge, and a quarter-round shoe molding.

Doors: The east doorway, originally a window in the Jefferson pavilion, is framed by a 5" wide single-fascia architrave with an bead and quirk ogee molding. The south doorway has a 5" wide two-fascia architrave.

No. 2081: The 2' 7½" wide by 6' 6" high by 1¾" thick stile-and-rail door has six raised panels. Hardware: The door hardware includes a pair of 4" iron butt hinges; a 5¼" mortise lockset with a brass knob on the south face and a brass turnkey on the north face; and an oval keyhole escutcheon on the south face.

Window: The window in the west wall is framed by the circa 1831 5" wide single-fascia architrave and sits above a bullnosed sill. The 6/6 double rope-hung sash has 12" by 18" panes, 11/16" muntins, and a sweep thumb latch on the meeting rails. This sash originates from the circa 1822 window opening that was in the east wall.

Heating: A six-column, fourteen-section, cast-iron hot water radiator is positioned below the west window. There is an air-conditioning unit in the window.

Lighting/electrical: The room is lit by a ceiling fixture with an opal glass pillbox shade, and by fluorescent fixtures flanking the medicine cabinet. Other electrical elements include two switches on the east wall, and duplex receptacles on the east wall and on the partition at the south end of the bathtub.

Plumbing: Bathroom fittings include a bathtub with integral wall panels at the north end of the

PAVILION IX



Room 208 (bathroom), looking north



Room 209 (bathroom), looking southwest

west wall; an *American Standard* toilet marked “4049 Apr 11” on the east wall; and an *American Standard* lavatory set in a wood and plastic laminate cabinet on the east wall. The lavatory is marked “0475/6 20” “Jul 20” and “75/6 20 308 M83”.

Furnishings and fittings: A recent counter spans between the south wall and the partition at the south end of the bathtub. There is a mirrored medicine cabinet on the east wall, and a mirror mounted to the north wall.

Finishes investigation: No samples were analyzed from this area.

ROOM 209 BATHROOM

This 10' 6½" by 7' 4" bathroom in the south half of the circa 1831 west addition includes doorways in the east and south walls and a window in the west wall. The east doorway was formerly a window

opening in the southwest parlor of the Jefferson pavilion. The current plan and fittings date to the twentieth century.

Floor: Cork tiles, 12" square, cover the floor, which is at the same level as the floor in the adjoining bedroom (205). The tile was removed in April 2010 as part of the renovation of the pavilion.

Walls: The east wall is the original exterior brick rear wall of the Jefferson pavilion; the west and north walls are brick masonry dating to the west addition. The south wall, and the wall at the south end of the bathtub, are framed partitions. The walls are finished in plaster. A 6' 2" high dado of white ceramic tiles and black cap tiles extends along the north, west, and south walls above the bathtub.

Ceiling: The plaster ceiling is 10' 3" above the floor.

Baseboard: The 5¼" high wood baseboard includes a splashboard with a flush bead at the top

ARCHITECTURAL DESCRIPTION

edge, and a quarter-round shoe molding.

Doors: The east doorway, originally a window in the Jefferson pavilion, is framed by a 4¾" wide single-fascia architrave composed of an outer ogee molding, a fascia, and a bead at the opening. The south doorway has a similar, but more recent, trim.

No. 2091: The 2' 10¼" wide by 6' 6" high by 1¾" thick door has six raised panels. Hardware: The door hardware includes a pair of 3½" iron butt hinges; a 5¼" high lockset with brass knobs; and a covered keyhole escutcheon (type B) on the east face. There is no keyhole cut into the door.

No. 2092: The door has been removed from this opening. Evidence for a pair of 4" high butt hinges on the west jamb indicates that the door opened north, into this bathroom.

Window: The window in the west wall is framed by the original circa 1831 5" wide single-fascia architrave and sits above a bullnosed sill. The 6/6 double rope-hung sash is the original Jefferson sash, reused from the window that was originally in the east wall. The sash has 12" by 18" panes, 11/16" muntins, and a sweep thumb latch on the meeting rails.

Heating: A six-column, thirteen-section, cast-iron hot water radiator is positioned below the west window. There is an air-conditioning unit in the window.

Lighting/electrical: The room is lit by a ceiling fixture with an opal glass pillbox shade, and by fluorescent fixtures flanking the medicine cabinet. Other electrical elements include switches on the east and south walls, and duplex receptacles on the east wall and west walls.

Plumbing: The bathroom is fitted with a cast-iron enameled bathtub on the west wall; an *American Standard* toilet marked "3245 NOV 09 02" on the east wall; and a pedestal lavatory on the east wall.

Furnishings and fittings: A counter with chrome towel bars spans between the south wall and the partition at the south end of the bathtub. A black ceramic soap holder, and a black ceramic towel bar are integrated into the tile dado. A mirrored medicine cabinet is mounted to the east wall, there is a

large mirror on the north wall, and another mirror is mounted to the architrave of the east doorway.

Finishes investigation: No samples were analyzed from this space.

ROOM 210 CLOSET

This small, 3' 3" by 7' 4" closet was created in the twentieth century from the south end of room 209. The space includes a doorway in the north partition and a window in the south wall.

Floor: Cork tiles, 12" square, cover the floor. The tile was removed in April 2010 as part of the current renovation of the pavilion.

Walls: The east wall is the original exterior brick rear wall of the Jefferson pavilion; the west and south walls are brick masonry dating to the circa 1831 west addition. The north wall is a later framed partition. The walls are finished in plaster.

Ceiling: The plaster ceiling is 10' 3" above the floor.

Baseboard: The 5¼" high wood baseboard includes a splashboard with a flush bead at the top edge, and a quarter-round shoe molding.

Doors: The north doorway has a 4¾" wide single-fascia architrave.

Window: The later window in the south wall is contemporary with the construction of the south-west addition (1896–1900); it can be seen in an exterior photograph of the pavilion in 1900. The opening is framed by a 4½" wide single-fascia architrave and sits on a sill with chamfered edges above a 4¾" high beaded fascia. The 6/6 double rope-hung sash has 10" by 12" panes, ⅝" muntins, and a sweep thumb latch on the meeting rails.

Lighting/electrical: The room is lit by an opal glass ceiling fixture with a pillbox shade (smaller than the fixture in the adjacent bathroom).

Furnishings and fittings: Clothes rods extend across the east and west walls. There is a shelf on the east wall, and three tiers of shelving on the west wall.

Finishes investigation: No samples were analyzed from this space.

PAVILION IX



View of the rafters and ridge beam. Note the ledgers (fastened to the two rafters immediately south of the chimney breast) that may be evidence of an early roof hatch.

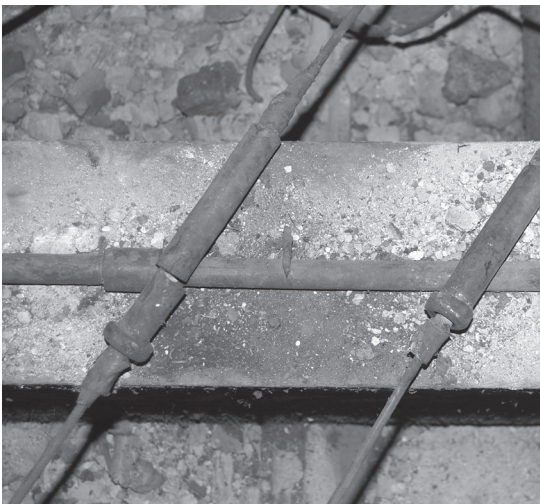

An electrical cable that lies on a gas pipe is sleeved with a porcelain tube.



Capped-off gas pipe with original escutcheon.

ARCHITECTURAL DESCRIPTION



The chimney in the attic

ATTIC

The original attic space extends over the entire area of the Jefferson pavilion beneath the framing of the hipped roof that rises to the central chimney mass. The impressive brick chimney is the primary feature in the attic. It consists of two separate chimneys that rise up from the basement foundations, then join in the attic with an arch that in turn supports the central chimney that extends above the roof. A similar condition can be found in the attic of Pavilion II and in Pavilion V, where the arch is visible in the second floor hall.

Access to the attic is through an opening in the ceiling at the west end of the second floor hall (201).

PAVILION IX

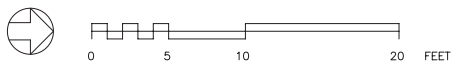
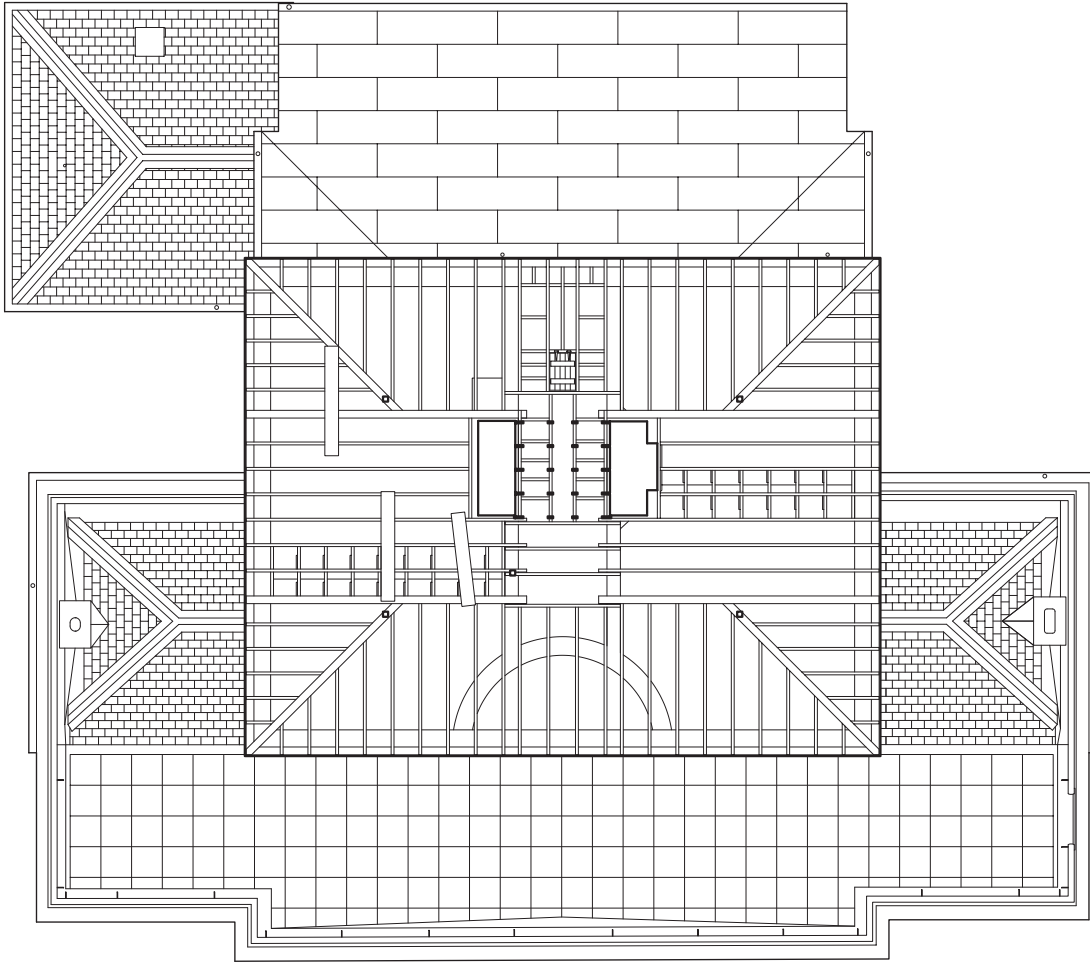

Attic floor plan, showing framing of second floor ceiling

ARCHITECTURAL DESCRIPTION

Floor: Two pairs of original 6" by 11" beams, extending north/south on each side of the chimney mass, divide the floor framing into three bays. In the center bay, the floor joists (typically 2¼" to 2½" thick by 11" high, spaced 1' 7" to 1' 9" apart on center) are set north/south. The original floor joists in the outer bays are laid perpendicular to the outer walls, framing into 6" by 11" beams that run diagonally from each corner to the central beams. All of this framing appears to be original.

In the west bay, the joists are framed around the attic hatch that provides access from the second floor hall (202). The 1' 6" by 2' 3½" board-and-batten door opens on a pair of strap hinges.

The joists hold up the ceilings of the second floor rooms with varying types of lath and plaster. The ceiling above room 201 retains original split lath and plaster. Along the north side of the attic, the ceilings above 203 and 204 consist of split wood lath covered by recent expanded metal lath and plaster. The ceiling above 205 has an earlier twentieth-century type of expanded metal lath with plaster.

Roof framing: The original common rafters (3" by 5", spaced 1' 9" to 1' 11" apart on center) of the hipped roof are nailed to 4" by 5" hip rafters, which in turn are mortised and pegged at the main ridge board. The center six rafters supporting the east and west planes of the roof extend straight to the ridge board. The rafters support 8¼" to 11" wide tongue-and-groove sheathing boards. Collar beams are mortised into the rafters approximately 3' 6" above the tops of the joists.

Ledgers fastened to the two rafters immediately

south of the chimney breast and west of the ridge board may be evidence for an early roof hatch.

Chimney: The joists are framed around two original chimney masses, one north and one south. Immediately above the level of the joists, the chimneys arch towards the center to form one central chimney mass (4' 11" square at the roof). The semicircular arch below the chimney is supported by wood bracing, used as support for the twentieth-century reconstruction of the upper portion of the chimney.

Lighting/electrical/gas: The attic area retains evidence for various early lighting systems that serviced the floors below. The earliest consists of long runs of gas piping and extensions that passed through the ceilings to apparently support gasoliers in rooms 203 and 204 and possibly in room 205. There are also remnants of knob and tube electrical wiring. The porcelain tubes are finished in a brown glaze. More recent electrical conduit is also visible throughout the space.

Other features: Centered along the east side of the attic, and attached to the brick wall, is the semicircular brick wall structure of the recessed entry niche that is the primary feature of the front facade. Lower down in the exposed brick shaft, the parged back side of the semi-dome is covered in a thick layer of dust and debris. The attic floor joists pass over the shaft and are supported on the plate at the top of the east wall.

Furnishings and fittings: A pile of woodwork, positioned immediately north of the access opening, includes the architrave and jamb of the original window opening removed from the west wall of room 102 in the twentieth century.

PAVILION IX

STUDENT ROOMS

STUDENT ROOM NO. 53 (NORTH)

This is the north room of the two original student rooms that flank and are attached to Pavilion IX. The 11' 8" by 13' 8½" room includes a single entrance doorway centered in the east wall, a single window in the west wall, and a chimney breast and fireplace centered on the north wall. Twentieth-century built-in closets are positioned in the southeast and southwest corners. The only plumbing amenity is a small lavatory installed circa 1929. The fireplace is functional, but heat is provided by a radiator below the west window.

Floor: The later 2¾" wide tongue-and-groove floorboards are laid north/south.

Walls: All four original brick masonry walls are finished with plaster. In the southwest and southeast corners of the room, twentieth-century wood partitions enclose a lavatory (southwest) and a closet (southeast).

Ceiling: The plaster ceiling is 10' 10½" above the floor.

Baseboard: The original 5¾" high baseboard includes a splashboard trimmed with a flush bead at the top edge and a later quarter-round shoe molding.

Picture rail: A later 2¼" high wood molding is positioned 10' 6½" above the floor on all four walls and on the south face of the chimney breast.

Door: The original doorway in the east wall is framed by a 5" wide single-fascia molding. The twentieth-century doorways in the north partitions of the southeast and southwest enclosures have plain fascia trim.

No. 153: The 3' 0" wide by 6' 3" high by 1½" thick stile-and-rail door has six raised panels. Hardware: The door hardware includes a pair of 5" iron butt hinges; a 5¼" high mortise lockset with brass knobs and an interior, stamped brass, oval keyhole escutcheon; and a deadbolt, chain bolt, and two metal hooks on the interior face. A bronze letter slot has been inserted in the lock rail. A recent oval plaque on the exterior face is engraved with "53" and the name of the resident.

Southwest (lavatory) door: The twentieth-century, 2' 4" wide by 7' 0" high by ¾" thick, stile-and-rail door has six panels: recessed panels on

the north face, and flush panels on the south face. The bottom edge of the door has been cut out to form a curvilinear vent. Hardware: The hardware, contemporary with the door, includes three 2½" high butt hinges and a small brass knob.

Southeast (closet) door: This door and its hardware are similar to and contemporary with the southwest door and hardware.

Window: The original window opening in the west wall is framed by a 4¾" wide single-fascia architrave and sits above a 1" bullnosed sill. The replica 9/9 double rope-hung sash has 10" by 12" panes, ⅝" muntins, and a brass sash latch.

Fireplace: An original plastered brick chimney breast projects from the north wall. The brick firebox is framed by a painted cement surround, in turn bordered by a 6" wide single-fascia wood architrave. A plain frieze above the architrave supports a 5' 4" wide plain, square-cut mantel shelf (4' 2½" above the floor).

The mantelpiece is a twentieth-century restoration.

The 4' 0" wide brick hearth projects 1' 11" from the surround. It is made up of 3¾" by 8" painted brick pavers.

Heating: There is a seven-column, sixteen-section cast-iron radiator near the west window. A *Hunter* fan/light fixture is suspended from the center of the ceiling.

Lighting/electrical: Ambient electrical lighting fixtures are positioned above the closet and lavatory enclosures. Other electrical elements include two switches in the east wall; duplex receptacles in the north wall; and duplex receptacles on the partitions enclosing the closet and lavatory.

Inside the lavatory enclosure, a sconce with a dome shade is mounted to the partition above the lavatory.

Plumbing: In the southwest enclosure, an *American Standard* enameled cast-iron lavatory is mounted to the south partition.

Furnishings and fittings: Inside the southwest lavatory enclosure, three tiers of wood shelves are mounted to the east and west partitions. The southeast closet includes a clothes rod and shelf.

Finishes investigation: No samples were analyzed from this room.

ARCHITECTURAL DESCRIPTION

STUDENT ROOM NO. 55 (SOUTH)

The 11' 8" by 13' 8½" south room of the two original student rooms that flank Pavilion IX mirrors the north room: a single entrance doorway is centered in the east wall; a single window is centered in the west wall; a chimney breast and fireplace are centered on the south wall; and built-in closets, constructed in the twentieth-century, are positioned in the northeast and northwest corners. The only plumbing amenity is a small lavatory installed circa 1929. The fireplace is functional, but heat is provided by a radiator below the west window. This room retains more of its original finishes than No. 53.

Floor: The original 5" to 6" wide tongue-and-groove floorboards are laid north/south.

Walls: All four original brick masonry walls are finished with plaster. In the northwest and northeast corners of the room, twentieth-century wood partitions enclose a lavatory (northwest) and a closet (northeast).

Ceiling: The plaster ceiling is 10' 9" above the floor.

Baseboard: The original 5¾" high baseboard includes a splashboard trimmed with a flush bead at the top edge and a later quarter-round shoe molding.

Picture rail: A later 2¼" high wood molding is positioned 10' 5" above the floor on all four walls and on the north face of the chimney breast.

Door: The original doorway in the east wall is framed by a 4¾" wide single-fascia molding. The doorways in the south partitions of the northeast and northwest enclosures have plain fascia trim.

No. 155: The original 3' 0" wide by 6' 3" high by 1½" thick stile-and-rail door has six raised panels. Hardware: The door hardware includes a pair of 4¾" iron butt hinges; a 5¼" high mortise lockset with brass knobs; a *Best* deadbolt with a turnkey knob; and a chain bolt. A bronze letter slot has been inserted in the lock rail. An oval plaque on the exterior face is engraved with "55" and the name of the resident.

Northwest (lavatory) door: The twentieth-century 2' 4" wide by 7' 0" high by ¾" thick stile-and-rail door has six panels: recessed panels on the south face, and flush panels on the north face. The bottom edge of the door has been cut out to form a curvilinear vent. Hardware: The door hardware includes three 2½" high brass butt hinges and a

small brass knob.

Northeast (closet) door: This door and its hardware are the same as the northwest door.

Window: The original window opening in the west wall is framed by a 4¾" wide single-fascia architrave and sits above a 1⅝" bullnosed sill. The replica 9/9 double rope-hung sash has 10" by 12" panes, ⅝" muntins, and a reproduction brass sash latch.

Fireplace: The original plastered brick chimney breast projects 1' 6" from the south wall. The brick firebox is framed by a painted cement surround, in turn bordered by a 6" wide single-fascia wood architrave. A plain frieze above the architrave supports a 5' 3½" wide plain, square-cut mantel shelf (4' 2½" above the floor).

The mantelpiece is a twentieth-century reproduction.

The 4' 1" wide painted brick hearth, projecting 2' 5¼" from the surround, is framed by a narrow wood molding.

Heating: There is a three-column, twelve-section cast-iron radiator near the west window. An electrical fan is suspended from the center of the ceiling.

Lighting/electrical: Ambient electrical lighting fixtures are positioned above the closet and lavatory enclosures. Other electrical elements include two switches in the east wall; duplex receptacles in the south wall; a switch on the east partition of the lavatory enclosure; and duplex receptacles on the partitions enclosing the closet and lavatory.

Inside the northwest enclosure, a sconce with a dome shade is mounted to the partition above the lavatory.

Plumbing: In the northwest enclosure, a *Crane* enameled cast-iron lavatory is mounted to the north partition. The lavatory is marked "2371-26x14" "CAN PAT 1929 US PATENT 1815705 MADE-IN-USA."

Furnishings and fittings: Inside the lavatory enclosure, three tiers of wood shelves are mounted to the east and west partitions, and there is a medicine cabinet above the lavatory. The northeast closet includes a clothes rod and two shelves.

A recent freestanding loft unit extends across the west wall. Matching shelving spans between the two enclosures on the north wall.

Finishes investigation: No samples were analyzed from this room.

PAVILION IX



Pavilion IX from the west

PAVILION IX

PROBLEMS OF REPAIR

Pavilion IX has survived in relatively good condition. Until the late twentieth century, little or no attention was given to building conservation and preservation issues. Repairs and maintenance were provided to meet the needs of the institutional setting. The pavilion was used primarily as a residence. Generally, repairs and improvements were made during the intervals between long term occupancies.

EXTERIOR

While detailed problems of repair have been itemized for the exterior of the building, many of the problems are repetitive and have been summarized below:

Masonry

1. There are eroded and open mortar joints in the brickwork. Pointing repairs have often been made with mortar that does not match the color, profile, or strength of the original mortar. In some instances heavy applications of modern sealants have been used in place of mortar.
2. The brick masonry is soiled and has areas of algae, lichen, and moss growing on its surface. The brickwork is eroded in localized areas.
3. Water ponds in the areaway to the north of the pavilion. The brick retaining wall of the areaway has open joints and stepped cracking.
4. There is stepped cracking in the brickwork above and below window openings and above exterior door openings.

Roofing

1. Much of the roofing slate is chipped, cracked, and broken.
2. The painted terne-coated steel gutter system and roofing is rusting. The contact of dissimilar metals in the roofing, gutters, and flashings (including copper, terne-coated steel, galvanized steel, and terne-coated stainless steel) creates galvanic couples that accelerate corrosion of the metals.

PAVILION IX



Roof eave at southwest corner of pavilion. Temporary repairs at seams in the sheet metal gutter have been removed, exposing unpainted terne-coated steel. The exposed metal is rusting and the seams have been caulked in an attempt to prevent water infiltration. The painted wood cornice above the plumbing vent is rotting. The flat-lock seams in the painted terne-coated steel roofing on the rear addition are rusting.

3. The sheet metal pan size used on the roof of the rear addition and porch is too large; the narrow seams cannot adequately accommodate the expansion and contraction of the metal.

Windows

1. Window glass is cracked. Glazing putty is cracked and missing.
2. The window air-conditioning units on the north, west, and south elevations are visually obtrusive.

Wood Construction

1. Individual wooden elements on the exterior of the building, including portions of the cornice construction, shutters, window sash and sills, and the curb of the colonnade railing, are rotted.

PROBLEMS OF REPAIR



Roof eave at northwest corner of pavilion. The paint on the terne-coated steel gutter is peeling and the sheet metal is rusting. Caulk has been used to repair failed solder at the seams. The juxtaposition of dissimilar metals (copper ridge flashing and steel gutter) creates a galvanic couple in the presence of an electrolyte (rainwater) that accelerates the deterioration of the less noble metal (steel).

Finish and Appearance

1. There is overpainting and paint spatter on the brick masonry.
2. The exterior masonry and painted finishes are dirty. There are excessive layers of coatings on painted surfaces; the paint coatings are often faded, crazed and peeling.
3. Surface-mounted wiring and miscellaneous hardware have been affixed to the building. Some of these materials are no longer in service.
4. A heavy use of and reliance on modern sealants has evolved in the maintenance of the traditional construction. Often the sealant does not meet the specific needs of an application.

PAVILION IX

EAST ELEVATION OF PAVILION IX

1. The penciled and stained (red-washed) mortar near the brick paving of the colonnade is broken and eroded, exposing the bright white color of the lime. Generally, the mortar on the east elevation is eroded and there are isolated areas of open joints.
2. The hardware cloth and wood screen protection at the south basement window is deformed and dirty.
3. Overpainting and paint spatter defaces the brickwork.
4. The painted finish on the south window is dirty. Glazing putty repairs have not been painted; they are dirty and mildewed.
5. The window moldings have been eroded by harsh paint preparation methods.
6. There are open holes in the masonry from missing shutter hold-backs.
7. The hardware cloth screens in the risers of the entry steps are deformed.
8. The finish on the entry steps and landing is eroded, and the wood substrate is exposed.
9. The plaster finish on the walls of the semicircular entry has vertical and horizontal cracks.
10. The painted finish on the wood entablature beneath the exedra is crazed.
11. All of the painted finishes are dirty.
12. The painted wood doors are abraded. The lower north panel has a vertical split.
13. The column capitals at the entry are dirty.
14. Bird nests and insect nests are located in the roof framing of the colonnade.
15. The whitewash/paint buildup on the columns of the colonnade is excessive; the layers of coatings are uneven. The column molding profiles are obscured.
16. The hardware cloth and wood screen at the north basement window is dirty.
17. The painted finish on the north window sash is dirty, and the glazing putty is cracked.
18. The painted finishes on the railings at the north and south windows are dirty and crazed.
19. The round, screened vents in the frieze of the colonnade entablature (outer face) are visually obtrusive. The vent holes appear to have been originally cut out for downspout outlets that can be seen projecting from the frieze in late nineteenth and early twentieth century photographs of the Lawn.

EAST ELEVATION ABOVE COLONNADE

1. The cornice moldings are splintered and gouged; much of the molding construction appears to have been replaced. Mitered joints are uneven, and many joints appear to be butt joints instead of more desirable mitered joints.
2. The copper nails in the copper cap flashings at the windows are loose or missing.
3. The painted terne-coated steel step flashing at the perimeter of the exedra is rusted. The paint is peeling.
4. The painted finish on the architrave of the exedra is crazed and has uneven layering. The moldings have cracks and gouges. The painted terne-coated steel flashing comes in contact with terne-coated stainless steel flashing at the face of the exedra; there is rust staining on the terne-coated stainless steel sheet metal. The painted wood sill beneath the architrave at either side of the semicircular niche is eroded. The north sill is cracked.
5. The flat-lock seam painted sheet metal flashing that caps the entablature above the entry doors is dirty. The flashing is flat with no apparent pitch to shed water.
6. There is over-paint and paint spatter on the brick masonry, especially adjacent to the window openings and shutters.
7. There are holes in the brick masonry where shutter hold-backs were previously mounted.
8. The painted finish on the shutters is faded, dirty, and peeling.
9. The painted finish on the window sash is cracked and peeling. The glazing putty is cracked, distorted, and missing.
10. The painted finish on the window architraves and frames is cracked and peeling; this condition is more advanced at the north window.
11. There is algae growing on the brick masonry behind the shutters, near the level of the colonnade roof.
12. The brick masonry immediately above the colonnade roof is soiled; there are open mortar joints. The only existing shutter hold-backs are located adjacent to the bottom rails of the shutters. These hold-backs are poorly anchored in the mortar joints.
13. There is stepped cracking in the brick masonry above each of the window openings.
14. Coaxial television cable is draped over the roof of the student room to the south and routed

PROBLEMS OF REPAIR



Northeast corner of the colonnade railing. The wood curb beneath the railing has insufficient pitch to drain properly. The metal railing support brackets are not flashed and rely solely on the integrity of sealant to prevent water infiltration.

PAVILION IX

north along the roof of the colonnade to the north window on the east facade of the pavilion. The fasteners used to secure the cable north of the exedra have been pulled loose.

15. Rusted iron spikes remain in mortar joints at the north and south ends of the east elevation where downspouts were formerly located. Overpainting is visible on the brickwork at the locations of the former downspouts.

16. The step flashing at the corners of the building is smeared with sealant. The intersection of the flashings at the southeast corner was poorly fabricated; the detail allows water to drain behind the flashing.

17. The drip edge at the eaves of the north and south student room roofs is rust stained by water draining from rusted galvanized downspouts.

18. Interlocking rubber composition tiles have been laid on filter fabric resting on a membrane roof applied to the deck of the colonnade. The rubber tiles catch leaves at the perimeter of the field, and they appear to retain moisture for extended periods of time.

19. The wood construction of the colonnade railing is not detailed to effectively shed water. The wood cap construction at the curb is nearly flat; the seams in the wood construction are separating, allowing water to infiltrate the joints.

20. The painted metal brackets that support the colonnade railing are not flashed; water will enter the wood curb construction as the caulked seams fail.

21. The wood curb construction at the southeast corner of the colonnade railing is beginning to rot at the open wood joints. The wood cap construction at the northeast outside corner of the colonnade railing has buckled, and the joints are open.

EAST ELEVATION OF STUDENT ROOM NO. 55 (SOUTH)

1. The mortar joints at the base of the wall are eroded and open. Attempts to repoint the joints have been largely unsuccessful. Mortar is buttered over the edges of the brick. In an effort to make the repairs less obvious, the mortar was stained to match the brick.

2. There is an excessive buildup of paint layers on the paneled door. The paint has obscured the molding profiles. A small area of a lower door panel

has been stripped to the wood (pine) substrate. The lower north panel has a vertical split.

3. The door knob and escutcheon are loose. The keyed lock is a modern surface-mounted lockset.

4. A rectangular area of the brick above the door (1'± by 2'±) appears to have been abraded to clean off an application of paint or glue.

5. The paint on the door shutters is heavy and crazed. There is evidence of wood filler where previous hardware has been removed. The shutter hardware has a heavy buildup of paint.

6. The stucco beneath the colonnade ceiling has an uneven buildup of paint.

7. The graphics for the door numbering system on the student room doors is inconsistent from door to door.

8. The wired electrical devices mounted to the frieze at the southeast corner of the colonnade entablature are visually obtrusive.

9. The round screened vents in the frieze of the colonnade entablature (outer face) are visually obtrusive. The vent holes appear to have been originally cut out for downspout outlets that can be seen projecting from the frieze in late nineteenth and early twentieth century photographs of the Lawn.

EAST ELEVATION OF STUDENT ROOM NO. 53 (NORTH)

1. The painted finish on the door and door shutters is uneven and heavily built-up. The molding profiles on the door are obscured by the paint buildup.

2. The brass door knob and escutcheon are loose. The keyed lock is a modern surface-mounted lockset. The lock rail of the door has a visible Dutchman repair adjacent to the knob. Four of the six raised panels in the door have vertical splits.

3. The brickwork to the north of the door opening has been etched with graffiti.

4. Overpainting and paint spatter defaces the brickwork

5. Mortar is buttered over the edges of the brick at the northeast corner of the building. In an effort to make the pointing repairs less obvious, the mortar was stained to match the brick. The brickwork is dirty.

6. The door sill is abraded.

7. Miscellaneous hardware, peeling paint, and over-paint on the letter slot of the door detract

PROBLEMS OF REPAIR

from the door's appearance.

8. The graphics for the door numbering system on the student room doors is inconsistent from door to door.

9. The downspout between the student room and pavilion is leaking; algae is growing on the brick paving.

10. The north stone steps of the colonnade are eroded and have open mortar joints.

EAST ELEVATION OF SOUTHWEST ADDITION

1. The mortar in the brick wall construction beneath the level of the first floor windows is significantly eroded. There are open mortar joints at the basement level.

2. The painted, surface-mounted electrical conduit at the south end of the wall is visually obtrusive.

NORTH ELEVATION OF PAVILION IX

1. The cornice molding is rust-stained from rainwater runoff. The westernmost cornice board is cracked, and the painted finish is peeling from the eastern end of the cornice board.

2. The brickwork is spattered with paint.

3. The painted aluminum half-window screens are deformed, and their tracks are bent.

4. The glazing putty at the windows is cracked and missing. The wood substrate of the muntins is exposed.

5. Algae is growing on the wood window sills.

6. The window air-conditioning units are visually obtrusive; the enclosures are dirty and stained.

7. The window shutters are dirty; the paint is faded and peeling.

8. Algae and lichen are growing on the brick masonry above the stepped flashing of the student room roof.

9. Algae is growing on the brick masonry surrounding the first floor windows, at the ledge of the water table, and at the base of the basement wall in the areaway.

10. The surface of the brick wall is soiled. The pointing is inconsistent in color and profile.

11. Storm water from the downspout at the northwest corner of the pavilion, and from the downspout on the east side of the student room

(routed beneath the student room), drains into the concrete and brick areaway along the north wall of Pavilion IX. The steel drain grate at the west end of the areaway is heavily corroded and blocked by leaves. Water ponds in the areaway, promoting the growth of algae, lichen, and moss. A secondary areaway to the west and south is covered with algae, lichen and moss growth as well.

12. The painted finish on the galvanized downspouts is peeling. The outlet at the east end of the areaway is deformed.

13. Traces of white paint remain on the brickwork of the south and east walls of the areaway.

14. The pointing of the brick masonry in the outer wall of the areaway is broken and missing. There are stepped cracks in the wall at the east end of the areaway.

15. The painted finish on the basement window architraves is peeling, and the wood substrate is exposed.

NORTH ELEVATION OF STUDENT ROOM NO. 53 (NORTH)

1. The painted brick wall is dirty at grade level.

2. The wood entablature has uneven layers of built-up paint coatings. The moldings have uneven joints, and the painted finish is crazed.

3. The railing at the perimeter of the roof is dirty and stained by rainwater runoff.

NORTH ELEVATION OF REAR ADDITION & PORCH

1. The pointing on the rear addition is inconsistent in color and profile; mortar is buttered over the edges of the brick.

2. The painted finishes on the rear porch are peeling. Algae is growing on the painted metal flashing of the decking at the first and second floors. The lattice at grade level and within the areaway is dirty and has algae growing on it.

3. Algae is growing on the northwest brick pier of the porch.

WEST ELEVATION OF PAVILION IX

1. The mortar on the exposed brick surface to the north of the porch is inconsistent in color and profile. The repointing at the basement and first

PAVILION IX



The sheet metal ridge of the roof above the student room at the northeast corner of the pavilion is poorly detailed; sealant has been heavily applied to the joint between the dissimilar metals of the ridge and step flashing. The paint on the painted step flashing is peeling. The roofing slate is chipped and broken.

floor level is heavy-handed; the mortar is buttered over the edges of the brick. Algae is growing on the brick masonry at the projecting brick ledges and in the areaway.

2. The painted finishes at the first and second floor levels of the rear porch are dirty and peeling.

3. The painted finish on the lattice at the first floor and basement levels is peeling, and much of the wood substrate is exposed.

4. The brick tread at the base of the steps has open mortar joints. Algae and moss are growing on the brickwork.

5. The pointing of the porch piers is heavy-handed, and the joints are wide. The mortar is inconsistent in color and profile. Remnants of a white painted finish remain on individual bricks. The exposed mortar is generally hard Portland cement mortar. Some brick spalling has occurred,

and bricks in the southwest pier are abraded and broken at the outside corners.

6. The pointing on the west elevation of the rear addition, at the first floor level of the porch, has the appearance of putty, formed by hand; the joints are irregular. There are voids in the pointing, and ferrous nails and wood grounds in the brickwork.

7. The insect screen on the south leaf of the first floor screen doors is torn. The painted finish on the doors is dirty.

8. Two of the glazed lights in the fanlight above the first floor door opening are cracked. The glazing putty is cracked and missing.

9. The painted finish on the first floor wood decking is dirty.

10. At the first floor level, there is stepped cracking in the brickwork above the south porch door opening. The glazing putty on the glass doors and

PROBLEMS OF REPAIR



The north areaway is wet and supports the growth of algae, moss, and lichen. The drain grate is corroded and clogged with leaves.



The brick masonry of the retaining wall at the east end of the areaway is cracked and displaced.

transom is cracked and missing.

11. Remnants of surface-mounted telephone wiring remain at the intersection of the first floor porch ceiling and the brick wall construction. The painted finish on the wood ceiling slats is crazed.

12. There is overpainting and paint spatter on the brick masonry at the first and second floor levels.

13. The brick garden paving immediately west of the pavilion is covered with algae. Moss is growing in the open joints.

14. The painted finish on the flat-lock seam metal roofing applied to the second floor porch deck is peeling, and the metal substrate is exposed.

15. The painted finish on the second floor window architraves is crazed. The painted finish on the window and door shutters is dirty and faded. The paint on the door shutters is peeling.

16. The glazing putty at the second floor win-

dows is cracked and missing. The putty that remains has an irregular profile.

17. A single light in the upper sash of the south window is cracked.

18. The air-conditioning units in each of the second floor window openings are visually obtrusive.

19. The brick masonry beneath the south window at the second-floor level has stepped cracking. A previous attempt to repoint the brick masonry beneath the north window has failed, and stepped cracking has re-emerged at the south end of the window opening. The repointing beneath the north window does not match the color or profile of the adjacent pointing; the replacement pointing was done with hard Portland cement mortar.

20. The painted finish on the second floor door architrave and doors is dirty and crazed. The paint buildup is heavy. The glazing putty on the doors

PAVILION IX

and transom is irregular, cracked and missing.

21. The mortar in the joint above the flashing of the second floor sheet metal decking is cracked.

AREAWAY BENEATH WEST PORCH

1. The pointing on the west elevation of the pavilion is inconsistent in color and profile.

2. There is erosion of the brick construction along the west side of the areaway. This deterioration appears to be the result of damp conditions.

3. Algae is visible on the brick walls and stone steps of the areaway. The steps are worn and eroded.

4. The painted finishes on the south basement window and shutters are dirty. The painted aluminum window screen is dirty and deformed.

5. The intermediate stair stringers for the rear porch stairs are inadequately supported at the porch ledger board. The stringers have bird-mouth cutouts that result in minimal bearing at the upper ends of the stringers.

STORAGE ROOM BENEATH KITCHEN

1. The oil-filled space heater used to prevent freezing conditions within the space is a potential fire hazard. The heater is plugged into an adapter screwed into the overhead light socket.

2. Galvanized ductwork, venting the clothes dryer in the basement, is routed along the east wall of the room and is attached directly to the window shutter.

3. A vertical crack extends upward from the upper north corner of the window opening. The crack is active; previous mortar repairs in the brick masonry have failed.

WEST ELEVATION OF STUDENT ROOM NO. 53 (NORTH)

1. The wood entablature has uneven layers of built-up paint coatings. The painted finish is crazed.

2. Paint is spattered on the brick masonry, and weathered paint remains on the wall beneath the first floor window opening.

3. There are open joints in the brick masonry between the window architrave and the entablature.

4. The mortar is inconsistent in color and profile. Hard, Portland cement mortar has been used for repointing. Much of the mortar in the joints beneath the first floor window has been buttered

over the edges of the brick.

5. Miscellaneous unused hardware remains attached to the brick masonry.

6. The slide bolts in the beaded board access door of the crawlspace are rusted, deformed and missing pieces.

7. The brickwork above the areaway, at the inside corner of the student room and pavilion, has open joints.

8. The concrete paving of the areaway running parallel to the west elevation of the student room is cracked. Algae is growing on the concrete.

9. The outer brick wall of the areaway has significant open joints and stepped cracking. Algae is growing on the brick

10. The brickwork at the northwest corner of the student room is broken near grade level and has open mortar joints.

WEST ELEVATION OF STUDENT ROOM NO. 55 (SOUTH)

1. The brick masonry is soiled.

2. Algae is growing along the ledge of the water table and at the basement level.

3. Television coaxial cable is routed along the ledge of the water table.

4. A large area of the brickwork at the inside corner of the student room and pavilion has been poorly reconstructed (at basement level). The coursing and mortar joints are irregular. The color and profile of the mortar does not match that of the adjacent wall construction. The mortar is a hard, Portland cement mortar. There are open mortar joints near grade level.

5. The painted aluminum half-window screen is deformed and torn.

6. The intersection of the lower rail and inside stile of the north window shutter is rotted.

7. There are cracked and broken bricks adjacent to the plywood access panel of the crawlspace.

WEST ELEVATION OF SOUTHWEST ADDITION

1. The pointing is inconsistent in color and profile. The mortar near the base of the wall is eroded. There are voids in the pointing. The brickwork at the base of the wall has been stained by splashback from the red clay soil.

2. The painted finish on the wood window shutters is faded and peeling. The lower rails of the

PROBLEMS OF REPAIR



The pointing repairs above the roof of the student room at the southeast corner of the pavilion do not match the color or profile of the original mortar. The brick in this area is discolored where previously applied stucco has been removed. A heavy application of sealant has been applied above the step flashing.

shutters are rotted.

3. The painted aluminum half-window screen is deformed.

4. The window glazing putty is cracked; sections of the putty are missing.

5. There are open mortar joints above and below the window opening.

6. Chalking paint has discolored the brick masonry immediately beneath the window sill.

7. The brickwork at the lower, southwest corner of the rear addition is abraded, chipped, and broken.

SOUTH ELEVATION OF PAVILION IX

1. The paint on the entablature is peeling, and the joints in the moldings are uneven.

2. There is some staining on the cornice from

rainwater runoff, near the center of the south elevation.

3. There is paint spatter on the brick masonry, and the brickwork is generally soiled.

4. The color and profile of the mortar is inconsistent. Much of the mortar is cracked and has spalled.

5. The pointing mortar above the student room roof has been buttered over the edges of the brick. This mortar does not match the adjacent mortar in color or profile. Hard, Portland cement mortar was used for the replacement pointing.

6. The painted half-window aluminum screens are deformed; their tracks are bent. The glazing putty at the windows is cracked and badly deformed, and the window sills are eroded and have peeling paint.

7. The wood substrate of the window sill above

PAVILION IX

the student room is exposed and appears rotted where it meets the ridge flashing of the roof below.

8. Sealant has been heavily applied above the stepped flashing of the student room roof. Vertical solder seams in the flashing are broken.

9. Television coaxial cable is routed across the face of the brick masonry above the first floor windows and draped across the roofs of the student room and southwest addition. A hole has been drilled through the brick wall of the pavilion, immediately west of the student room, for the passage of the cable. Television coaxial cable has also been routed along the ledge of the water table above the basement windows.

10. The paint on the shutters is dirty, faded, and peeling; the wood substrate is exposed in some areas.

11. Algae is growing on the brick ledge of the water table and at the base of the south wall.

12. The pointing at the basement level is inconsistent in color and profile. Much of the mortar between the basement and first floor windows is eroded.

13. The brick masonry above the basement window, immediately east of the southwest addition, has been rebuilt to address deflection and cracking. The new brick does not match the adjacent brick in color or size. The mortar joints have been made excessively wide to accommodate the new brick. The mortar does not match the surrounding mortar in color, profile, or hardness. The new mortar is a hard, Portland cement mortar.

14. The concrete drainage paving at the base of the wall is cracked. Algae is growing on the concrete, and leaves clog the drain at the west end of the paving.

15. The air-conditioning unit in the basement window opening immediately east of the southwest addition is visually obtrusive. The enclosure is dirty and stained.

16. The brick masonry is soiled.

17. The painted finish on the south face of the second floor rear porch is peeling. The wood construction appears to be eroded.

SOUTH ELEVATION OF STUDENT ROOM NO. 55 (SOUTH)

1. Vines are growing on the brick masonry and may be contributing to moisture retention problems.

2. The brick masonry is soiled.

3. The mortar profiles are inconsistent, and there are areas of eroded mortar. The brick at the southeast corner of the room, near grade level, is spalled.

4. Television coaxial cable is routed across the brick near the southwest corner of the room to a terminal box located at grade level.

5. The colonnade railing is dirty.

6. There are ferrous nails driven into mortar joints near the southeast corner of the room.

SOUTH ELEVATION OF SOUTHWEST ADDITION

1. The brick masonry is soiled, and there is paint spatter on the brick.

2. The painted finish on the window shutters is faded and peeling.

3. The glazing putty on the first floor windows is cracked and irregular. The paint on the sash is beginning to peel.

4. The window air-conditioning unit at the first floor level is visually obtrusive.

5. The mortar between the basement window openings is eroded.

6. The mortar used to repair the stepped cracking above the first floor east window does not match the color of the adjacent mortar.

7. The color and profile of the pointing across the face of the wall is inconsistent. Mortar has been buttered over the edges of the brick.

8. The basement window frames and sills are eroded. The glazing putty is cracked in the west sash and unpainted in the east sash.

9. A painted aluminum-framed screen has been screwed to the face of the east window frame.

ROOF OF PAVILION IX

It should be noted that references to terne-coated stainless steel (TCS) at Pavilion IX actually refer to TCS II, a roofing product manufactured by Follansbee Steel. This roofing is not actually terne-coated stainless steel. It is Type 304 stainless steel coated with a proprietary tin/zinc alloy (ZT Alloy) formulated by Follansbee.

Main Roof: As seen from southeast corner

1. The hipped roof has copper ridge caps that meet painted terne-coated steel sheet metal flashing at the central chimney, and painted terne-coated steel sheet metal gutters at the eaves. A galvanic

PROBLEMS OF REPAIR

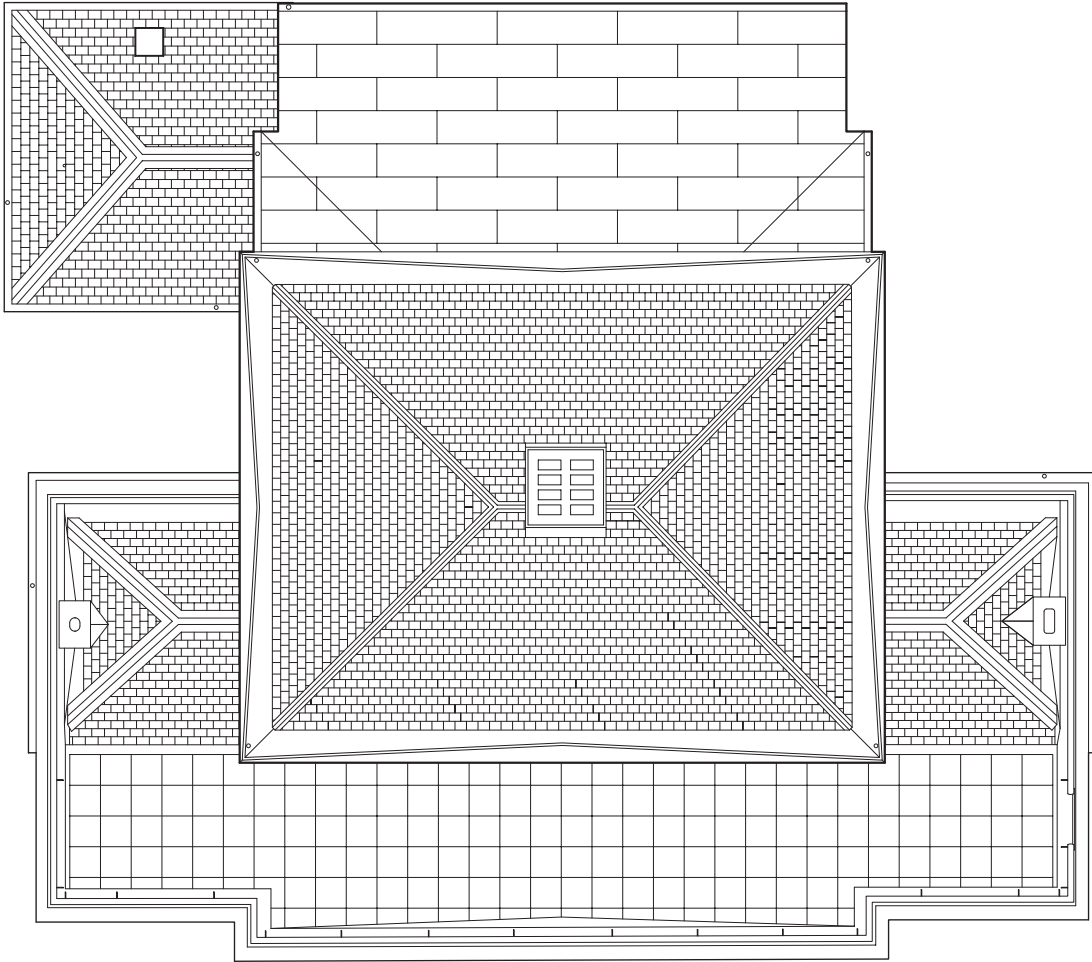

Roof plan

PAVILION IX



Southwest corner of rear addition. The bottom rail of the upper window sash on the south elevation has failed. A heavy application of sealant has been applied above the step flashing and between the dissimilar metals of the step flashing and ridge. Brick replacement and pointing repairs have not been carefully executed.

couple between the dissimilar metals may be promoting accelerated corrosion of the steel.

2. The flat-lock seams of the built-up gutters have multiple generations of seam sealant. The sealant appears to have been applied in an attempt to address leaks.

3. Repointing campaigns for the brick construction of the central chimney have been heavy-handed. There are wide mortar joints, and mortar has been buttered over the edges of the brick. Mortar color matching has not been successful.

4. Rust is visible in the terne-coated steel sheet metal at the eaves. Rust is showing through the paint, as well as forming on unpainted, unprotected areas of metal where previous generations of seam sealant have been removed.

5. The roof slate is chipped and broken.

Main Roof: As seen from northeast corner

1. The painted finish on the terne-coated steel sheet metal roofing at the northeast corner of the roof is peeling. The sheet metal is rusting.

2. Water is pooling at depressions along the built-up north gutter.

3. The painted terne-coated steel gutter and flashing along the entire north elevation of the roof is covered with surface rust.

Main Roof: as seen from the west

1. The built-up gutter system on the main roof is clad with painted terne-coated steel sheet metal. The paint is peeling, and the substrate is exposed.

PROBLEMS OF REPAIR

The sheet metal is rusting. The seams in the sheet metal have been repaired with caulk.

2. The painted finish on the wood entablature of the main building is crazed and peeling. The wood substrate is exposed. The moldings are separating from one another. A sheet metal patch has been screwed to the cornice above the north hip of the rear addition.

3. The wood cornice construction is discolored and rotting above the south plumbing vent that is located beneath the overhanging cornice.

4. The roof slate is chipped, cracked, and broken.

5. The copper ridge flashing appears to be nailed in place with galvanized nails, creating a galvanic couple between the dissimilar metals. The sections of flashing have separated at their overlapping joints.

Roof of Rear Addition and Porch

1. The painted, terne-coated steel, flat-lock seam roofing on the porch and rear addition is rusting at the seams.

2. The large size of the sheet metal pans in the flat-lock seam roofing makes it difficult to align the pans for fully engaged, completely formed seams. Incremental thermal expansion and contraction is magnified as well; with fewer seams, more movement must be accommodated at each seam.

3. The painted finish on the metal roofing is dirty.

4. The painted steel gutters at the north and south ends of the addition are rusting.

5. The steel downspouts at the northwest and southwest corners of the upper roof are rusting.

Roof of Student Room 55 (South)

1. The slate on the hipped roof is chipped, cracked, and broken. Temporary sheet metal repairs have been made where the slate is broken.

2. The juncture of the terne-coated stainless steel flashing and the wood curb cap of the south railing is insufficiently designed to shed water. The metal flashing and wood construction meet at a close-fitting, overlapping joint with little or no pitch.

3. A heavy application of sealant has been used where the stepped terne-coated stainless steel flashing and ridge cap meet the south wall of the pavilion.

4. The butt joints in the wood curb construction of the railing surrounding the south student room are beginning to open, allowing water to infiltrate

the construction.

5. The chimney above the student room has been poorly repointed with thick, buttered joints of hard Portland cement mortar. The bricks have spalled, and cracks have opened between the mortar and bricks. Algae and lichen are growing on the brick at the base of the chimney.

6. A thick sealant joint separates the brick at the base of the chimney from the terne-coated stainless steel sheet metal enclosure / flashing at the south eave of the roof.

Roof of Student Room 53 (North)

1. The slate on the roof is chipped, cracked, and broken. Sheet metal repairs have been made where the slate is broken. It appears that the sheet metal repairs were made when the roof slate was installed or relaid, suggesting that there was an insufficient supply of sound slate.

2. Painted, terne-coated steel step flashing at the north wall of the pavilion intersects with the new terne-coated stainless steel ridge and gutter flashing of the student room roof. The galvanic couple between the dissimilar metals may lead to accelerated corrosion of the steel. A heavy application of sealant has been applied at the juncture of the ridge and step flashing. The painted finish on the flashing is peeling.

3. The chimney above the student room has been repointed with a heavy, buttered application of hard Portland cement mortar. The brick has spalled, and cracks have opened between the brick and mortar. Algae, moss, and lichen are growing on the brick masonry. There are open mortar joints at the base of the chimney. An excessive amount of sealant has been applied to the joint between the flashing and the brick construction of the chimney.

4. The juncture of the terne-coated stainless steel flashing and the wood curb cap of the north railing is insufficiently designed to shed water. The metal flashing and wood construction meet at a close-fitting, overlapping joint with little or no pitch.

5. The butt joints in the wood curb construction of the railing surrounding the north student room are beginning to open, allowing water to infiltrate the construction.

6. Condensate draining from the window air-conditioning unit overhanging the student room roof is supporting the growth of algae on the west slope of the roof.

PAVILION IX

Roof of Southwest Addition

1. The brick chimney above the southwest addition is soiled. The reconstructed masonry near the top of the chimney does not match the appearance or size of the brickwork below.
2. Individual roof slates are chipped and broken.
3. The terne-coated stainless steel ridge flashing on the southwest addition has been (rust) stained by the rainwater runoff from the painted galvanized downspout at the southwest corner of the

pavilion.

4. A heavy application of sealant has been applied to the joint above the chimney flashing.

5. Copper flashing along the north edge of the roof comes in contact with painted terne-coated steel flashing at the southwest corner of the pavilion, and with the terne-coated stainless steel gutter to the west. The galvanic couple between dissimilar metals may accelerate corrosion of the less noble metal.

INTERIOR

The interior spaces of the building remain in relatively good condition. Bathroom and kitchen facilities have been confined to spaces within the additions. The original Jeffersonian spaces on the first and second floors remain intact, with openings and closures made in the original rear wall of the pavilion to accommodate the western additions.

The following summary of interior conditions provides an overview of significant and repetitive problems; a room-by-room survey of the problems follows.

Finish and Appearance

1. Plaster finishes are irregular and cracked, especially where penetrations have been made for piping and conduit, and where poor quality repairs have been attempted.
2. Rising damp and water infiltration have damaged plaster finishes; the painted plaster finishes have blistered, and the plaster is friable.
3. Excessive paint buildup has obscured molding profiles. Painted finishes are worn, soiled, chipped, cracked and peeling.
4. The fixtures and finishes in the bathrooms and kitchen are worn.

Woodwork

1. Moldings at the baseboards, stairs, windows, and doors are abraded.

Flooring

1. The wood floors are abraded and scuffed; the floor finishes are worn.
2. The flooring in the northeast quadrant of the basement consists of irregular brick paving with parged mortar.

Windows

1. There are cracked glass lights in many of the window sash.
2. There is a heavy buildup of paint coatings on the wood sash.

PROBLEMS OF REPAIR

3. The hardware and operation of the sash have been compromised in some locations; and in at least one location, the construction of the sash has failed.
4. The window air-conditioning units are visually obtrusive, and their installation has required ad hoc modifications at the window openings.
5. Paneling in the window reveals is cracked.

Doors

1. Paneling in the stile-and-rail doors is cracked.
2. Door hardware is loose and inoperable.
3. Poor quality repairs have been made where hardware has been removed, and holes have been repaired with fillers.

Stair

1. Visually obtrusive, additive repairs have been made to the main stair at the basement level in an attempt to strengthen the stair construction.
2. The beam used as a header for the first floor stair opening bears on an undersized lintel at the southeast basement window opening. The lintel is significantly deflected, and the flooring on the landing above has subsided.
3. Repairs to the handrail of the stair have been poorly executed and infused with fillers.

Building Systems

1. Piping and electrical conduit have been routed through spaces and mounted on the surfaces of interior finishes. The integrity of the brick walls in the basement has been compromised by the extent of piping and conduit.
2. The distribution piping for building heat and for the central grounds heating system is a significant intrusion in the basement. The piping restricts ceiling heights and impedes the use of basement rooms.

PAVILION IX



The header of the basement stair opening in Stair Hall B01 had insufficient structural support at the window opening. The flat board at the head of the window opening provided a finished surface for the reveal, but only limited structural support to carry the load of the stair framing or brick masonry wall. The board was significantly deflected.

ROOM B01 STAIR HALL

1. Friable plaster is visible at the base of the south, east, and northeast (curved) wall surfaces. This appears to be the result of rising damp.
2. Friable plaster to the south of the window opening appears to be the result of water infiltration from the colonnade downspout at the southeast corner of the pavilion (routed through the crawlspace under student room No.55).
3. Piping and electrical conduit are routed across the east wall (beneath the window) and across the south wall (beneath the stair). Heating pipes traverse the space and restrict the head height of the stair hall.
4. There are hairline plaster cracks and peeling paint beneath the stairway.

5. The paint buildup on the stair construction is excessive. The paint layering is uneven, and the paint obscures the molding profiles.

6. The paint buildup on the west door and on the door architraves obscures the molding profiles. The paint on the west door architrave and door is chipped and peeling. The finishes are dirty. The door and the architraves are abraded from heavy use. The strike on the south jamb of the west door is deformed and non-functional. The screw holes at the juncture of the architrave and jamb are stripped.

7. Telephone station wiring, stapled to the north door architrave, has been routed through a hole drilled into the architrave and lintel of the opening.

8. The painted plaster wall surfaces are dirty and cracked; the paint is peeling.

9. The stair treads and finishes are worn. The

PROBLEMS OF REPAIR

paint coatings on the stair stringers and balusters are built-up, obscuring profiles and detail. The scroll detailing and fascias are cracked and abraded. The baseboard cap molding along the lower three runs of the stair has an excessive buildup of paint; the molding profile is obscured. The foot of the basement newel post is abraded and gouged. A 4x4 wood post, set in the brick flooring, flanks the basement newel post and reinforces the inside corner of the two lowest stair runs. The post detracts from the original appearance of the stair construction. The hand rail at the bottom run of stairs is weak and unable to support normal loads; individual balusters are loose.

10. The east-west beam along the north edge of the stair opening bears on a broad, flat, and significantly undersized lintel above the east basement window. The lintel has been deformed by the imposed load of the stair construction and floor framing. The cased beam has cutouts remaining from construction that is now missing.

11. The plaster finish on the east wall, at the intermediate southeast landing of the stair, is blistered and friable. The water damage may have resulted from a leak in the colonnade downspout routed beneath the adjacent student room.

ROOM B02 HALL

1. The ceiling plaster is irregular, especially at the east end of the hall where peeling paint is also visible. Electrical conduit and surface-mounted wiring run the length of the hall ceiling.

2. Heating pipes run transversely (west to south) through the hall, from wall to wall, reducing the head height near the center of the space.

3. The exposed plaster wall surfaces are irregular, especially at the east end of the hall. There are hairline cracks and peeling paint. Water damaged plaster near the floor level, flanking the east door, appears to be the result of rising damp.

4. The southeast and west doors are missing. The door architraves are abraded, and the paint buildup obscures the molding profiles.

5. Telephone wiring has been routed across the surfaces of the ceiling, walls, and door architraves.

ROOM B03 HALL

1. Conduit and surface-mounted wiring are routed across the ceiling and walls. A large metal electrical junction box is mounted beneath the

ceiling in the southwest corner of the hall. Surface-mounted junction boxes are attached to the ceiling. The ceiling plaster is uneven and irregular above the conduit on the west wall, and above the wiring on the north wall.

2. The south door binds on its jamb. The painted finish on the beadboard door is scuffed and dirty. There are cracks in the vertical beadboard. The built-up paint coatings obscure the molding profiles on the door and architrave. The door architrave is abraded, especially near the floor level. The paint at the bottom edge of the door is chipped.

3. The plaster wall surfaces in the northwest and southwest corners of the hall are friable near the floor level. There appears to be rising damp in these locations.

ROOM B04 STORAGE

1. Rising damp along the east wall, and along the curved walls to the north and south, has caused mildew growth and peeling paint. The mortar has been leached from the curved brick walls, up to 4' 0"± above the masonry floor.

2. Surface-mounted conduit and telephone wiring is routed along the east wall. A telephone junction box and heating pipes are mounted to the east wall. Surface-mounted telephone wiring extends along the curved west wall, immediately beneath the overhead joists.

3. The brick floor has been parged with mortar. The parged surface is irregular, cracked and broken.

4. The window sash and window well near the top of the east wall are dirty. The window well is filled with insect nests and cobwebs.

5. The painted finishes are dirty.

6. The door hardware is loose, and the door does not latch.

ROOM B05 STORAGE

1. The brick floor has been parged with mortar. The parged surface is irregular, cracked and broken.

2. A gypsum board ceiling has been installed beneath the historic building construction. The taped seams are pronounced. The ceiling is dirty and scuffed.

3. Heating pipes and electrical conduit routed along the east wall, and heating pipes suspended from the ceiling, reduce the ceiling height of the space and impede the use of the room.

4. The plaster wall finishes at the south end of

PAVILION IX

the room are cracked, and the paint is peeling. The painted finishes are scuffed and dirty.

5. The south door is warped and difficult to latch. A large rectangular hole has been cut in the bead-board construction of the door and covered with hardware cloth; the screening has been pulled loose. The door architrave is abraded. Paint buildup on the door and architrave obscures the molding profiles. The door has been poorly repaired with wood plugs and filler where previous hardware has been removed.

6. Rising damp and water infiltration are occurring along the east and north walls. The wall plaster is friable, and the paint is peeling up to 3' 0"± above the finished floor. The water-damaged plaster extends from the floor to the ceiling in the northeast corner of the room. This damage appears to be largely the result of water infiltration from the leaking downspout routed under the adjacent student room.

ROOM B06

1. There is minor hairline cracking of the ceiling plaster. The plaster is irregular where penetrations have been made for heating pipes, and where an electrical junction box has been installed at the juncture of the north and west walls of the room. Heating piping has been suspended from the ceiling along the north and east walls, and electrical conduit is mounted on the west wall beneath the ceiling. The piping and conduit significantly reduce the head height of the room.

2. There is uneven plaster and hairline plaster cracks on all of the walls. The paint on the north wall is delaminating and peeling as a result of water infiltration.

3. The plaster at the base of the chimney mass, near the center of the south wall, is friable. The paint has blistered and cracked. This damage appears to be the result of rising damp.

4. The paint buildup on the window and door architraves obscures the molding profiles. The door and door architrave are abraded.

ROOM B07 ORIGINAL KITCHEN

1. Heating pipes are suspended from the ceiling, reducing the ceiling height in the room.

2. The air-conditioning unit in the southwest window opening is visually obtrusive. Acrylic panels flanking the air conditioner have been screwed

to the fixed sash.

3. The pair of casement sash in the southeast window opening appear to be reused from another location. Adhesive tape has been applied at the perimeter of the sash to prevent air infiltration.

4. There are hairline cracks in the wall plaster. The painted finish adjacent to the southeast window opening is bubbling and peeling; water appears to have been infiltrating the south wall.

5. Significant water infiltration has occurred in the southwest corner of the room. The plaster above the window sill is friable. The paint layers on the west window reveal are uneven, and the splayed wood reveal is cracked and warped. The water problems appear to be the result of a failed downspout at the inside corner of the southwest addition and original pavilion. The mortar has been leached from the exterior brick masonry in this corner. The downspout has been replaced and relocated approximately 2' 0" south of the corner, on the east face of the southwest addition. Additional damage associated with this problem was found in the southwest corner of room 103 and the northeast corner of room 108.

6. The molding profiles on the door and window architraves are obscured by paint buildup.

ROOM B08 REAR VESTIBULE

1. Heating pipes and a soil pipe extend from wall to wall (north-south) beneath the ceiling, reducing the head height of the space.

2. Surface-mounted electrical conduit and wiring are routed over all ceiling and wall surfaces. A 200 amp electrical service panel is surface-mounted to the south wall, immediately west of the door opening. The plaster surfaces of the ceiling and walls are irregular where wiring and piping penetrate them, or where the wiring and piping are routed. This condition is particularly pronounced above the electrical service panel. The painted finish on the ceiling above the electrical panel is peeling.

3. The painted finish on the west door is uneven and dirty. There are horizontal cracks in the wood transom panel above the door, and a vertical crack in one of the beaded boards of the door.

4. The south door is missing (the south door opening had doors at each side of the opening; both are missing). The door jambs are abraded, especially near the floor level; built-up paint obscures the molding profiles.

PROBLEMS OF REPAIR

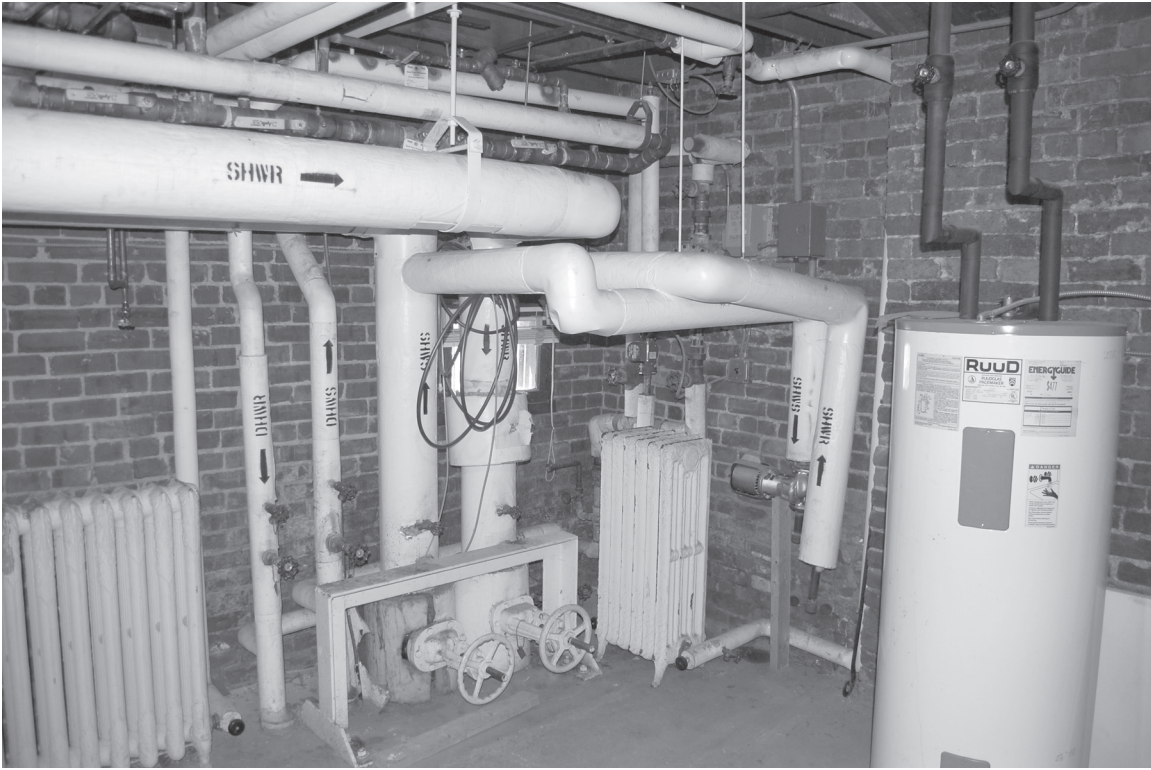

The piping for the central grounds heating system enters the basement of the southwest addition (Room B11) and is routed to the crawlspace north of Pavilion IX. The piping restricts ceiling heights and impedes the use of basement rooms. Room B11 is excessively hot and dry during the heating season.

B09 BATHROOM/LAUNDRY

1. The vinyl tile floor may contain asbestos.
2. Electrical conduit and heating pipes are mounted to and suspended from the plaster ceiling; the piping significantly reduces the head height of the space. The painted plaster finish above the piping has hairline cracks and uneven layers.
3. The lower light of the south casement sash has been replaced with a sheet metal panel that supports the exhaust vent for the clothes dryer. The exposed ductwork for the vent is routed from the southwest corner of the room, through the wing wall, to the window outlet.
4. A cast-iron soil pipe is routed through the space, entering beneath the ceiling on the south wall and exiting beneath the raised platform at the north end of the room. The pipe is routed along the

west wall, beneath the window. The raised platform at the north end of the room is needed to accommodate gravity drainage from the toilet and tub.

5. The door is warped, preventing it from latching. The painted finish on the door is built up, obscuring the molding profiles. The finish is dirty, and the vertical bead boards have cracked at the head and foot of the door. The base of the west door architrave is missing, and the paint on the architrave is peeling. This deterioration may be the result of rising damp. The plastered wall surface in the southwest corner of the room is irregular, and there are areas of peeling paint.

ROOM B10

1. The ceiling is largely obscured by heating pipes and a soil pipe extending the length of the

PAVILION IX



Room B11, looking north. The integrity of the brick basement walls has been compromised by the piping required for the central grounds heating system.



The mitered joints of the handrail on the stairway have been poorly repaired and infused with fillers.

room (from north to south). The piping significantly reduces the head height of the room. The ceiling has uneven paint layers, hairline cracks, and peeling paint.

2. The east and north doors are missing (the north door opening had doors at each side of the opening; both are missing). The outer molding of the north door architrave is missing from the head of the opening.

3. The south door, west window, and all of the window and door architraves, have built-up paint coatings that obscure the molding profiles. The door architraves and reveals are significantly abraded near the floor level. The displaced door stop molding at the south door prevents it from

latching. The south door jambs have been pieced together; they do not extend the full height of the door opening as continuous pieces.

4. Friable plaster is visible on the east and west walls at the north end of the space. This occurs near floor level, and appears to be the result of rising damp.

5. Electrical conduit and wiring are routed across the ceiling and all of the wall surfaces. Insufficient provision of lighting and electrical outlets has led to haphazard wiring with extension cords.

6. Extensive pipe penetrations above the north and south door openings appear to be compromising the structural integrity of the masonry wall construction.

PROBLEMS OF REPAIR

ROOM B11

1. This room serves as the entrance for the piping of the central grounds heating loop. The room is excessively hot during the winter. In addition to the heating main, there are three cast-iron radiators. It appears that the excessive levels of heat are used as a radiant source of heat for rooms 108 and 109 above. There is no finished ceiling in this space.

2. There is minimal evidence of rising damp on the south and west walls. The brick walls and concrete floor are generally in good condition. The mortar in the brick masonry to the east of the north door opening and along the east wall is soft and eroded.

3. Electrical conduit is routed over all of the exposed brick wall surfaces and beneath the exposed floor joists above.

4. There is no architrave on the south face of the door opening in the north wall.

5. There is stepped cracking and loose brick above the southeast window opening. The mortar in this area has lost its adhesion.

6. The penetration of the masonry above the north door opening for piping appears to be compromising the structural integrity of the wall construction.

ROOM 101 ENTRANCE HALL

1. The wood floor is abraded, and the finish is scuffed. Dutchmen repairs in the flooring are poorly matched to the adjacent flooring.

2. The paint coatings on the trim are built-up, and the molding profiles are obscured.

3. The dark, grained finish on the east entry doors is chipped and cracked, exposing the early reddish grained finish. The buildup of coatings on the paneled doors obscures the molding profiles. Where hardware has been removed from the doors the finish layers are irregular. The lower panel of the north door leaf has a significant vertical crack.

4. Cracked and delaminating finishes on the plaster surface of the south wall, and on the plaster wall surfaces adjacent to the west doorway, have been covered with later paint coating(s).

5. The dark, grained finish on the west doors is chipped, exposing earlier painted finishes and reddish graining. The south door leaf has been poorly repaired with filler where hardware has been removed.

ROOM 102 DINING ROOM (FORMER LECTURE ROOM)

1. The wood flooring is abraded and scuffed. Although the flooring is distressed and worn, it appears to be replacement flooring that does not adequately match the character and grain of the original flooring in the neighboring rooms. There are unfilled holes where radiator piping has been removed along the north wall, near the northeast corner of the room. The flooring adjacent to the hearth is cracked where it appears that the leading edge of the brick hearth has subsided. Dutchmen repairs in the flooring are poorly matched to the adjacent flooring.

2. A window air-conditioning unit has been hung in the northwest window opening; acrylic panels flank the air conditioner. This installation is obtrusive, and it detracts from the historic character of the room.

3. A single light in the lower sash of the east window on the north elevation is cracked.

4. The cracked and delaminated paint finishes on the plaster wall surfaces have been coated with subsequent layer(s) of paint.

5. The dark, grained finish on the southeast door is chipped, cracked, and peeling. Significant areas of the early reddish graining have been exposed on the north face of the door. The inner door stile has been indented where it impacts the plinth of the door architrave. The upper east panel of the door has a significant horizontal crack.

6. The dark, grained finish on the southwest door is chipped, cracked, and peeling, exposing earlier paint finishes and early reddish graining. The inner door stile impacts the architrave plinth.

7. There are large deposits of melted candle wax in the painted brick firebox and on the hearth.

ROOM 103 LIVING ROOM

1. The wood floor is abraded; the finish is worn.

2. Longitudinal (east-west) hairline plaster cracks extend across the ceiling, near the centerline of the room, and immediately south of the centerline. The cracks have recurred in skim coat repairs.

3. The east and northwest doors are missing.

4. The paint coatings on the wood trim are built-up, and the molding profiles are obscured.

5. There are diagonal, hairline plaster cracks

PAVILION IX

between the ceiling and the upper corners of the window architraves on the south wall.

6. At the southwest corner of the room, friable plaster near the floor level has been encapsulated beneath a later paint coating. The plaster damage appears to be the result of water infiltration associated with a failed downspout at the inside corner of the southwest addition and original pavilion (see B07 for additional information).

7. A cracked light is located in the upper and lower sash of the southwest window. The light in the lower sash has multiple cracks.

8. A cracked light is located in the upper sash of the southeast window.

9. The splayed panels in the window reveals have filled cracks and uneven paint layers. The paint buildup has significantly obscured molding profiles.

ROOM 104 STAIR HALL

1. The wood floor is abraded; the finish is scuffed.

2. The paint coatings on the trim are built-up, and the molding profiles are obscured.

3. The wood grained finish on the north door is chipped, exposing the base coat and substrate. The door binds on the hinge stile.

4. Hairline cracks in the wall plaster on the curved northeast wall have been coated, but they remain visible.

5. The stair treads are abraded, and the risers are scuffed. The finish on the treads has been worn away, exposing the wood substrate.

6. Paint coatings on the stair construction are built-up, and the molding profiles are obscured.

7. The handrail on the stair has missing splinters of wood. Some of these missing sections have been filled. The mitered joints of the handrail that meet above the newel posts have been splintered, broken, filled and reinforced.

ROOM 105 WEST VESTIBULE

1. The wood floor is abraded; the finish is worn. Gaps between the floorboards are filled with crud.

2. The painted plaster wall surfaces are scuffed and dirty. There is hairline cracking in the plaster.

3. There is uneven plaster at the juncture of the west wall and ceiling, and a hairline crack extends from the ceiling to the arch above the doorway.

4. The painted finish on the east door frame and transom is built-up, obscuring the molding pro-

files. The paint on the door architrave is chipped and peeling.

5. The paint on the plaster reveal of the west door is peeling.

6. Three of the lights in the semicircular west transom are cracked. The built-up paint coatings on the transom obscure the molding profiles.

7. The painted finish on the west doors is dirty and scuffed. The bottom light in the north door leaf is cracked. There are vertical cracks in the hinge stile of each door; the cracks are more pronounced on the north leaf.

8. The lockset on the west doors is not fully functional.

ROOM 106 KITCHEN

1. The cork floor tile has raised seams.

2. The kitchen casework is worn; the cabinet doors are racked and have operational problems.

3. There are hairline cracks in the plaster ceiling.

4. An open crack is visible at the perimeter of the south wall partition separating the kitchen from the rear vestibule (105).

5. The painted finishes at the windows (including sash, architraves, and sills) are built-up and peeling. The molding profiles are obscured by paint. A window air-conditioning unit has been installed at the north window opening, with vinyl accordion panels flanking the air conditioner. The installation is visually obtrusive.

6. The painted plaster finish is blistered and cracked at the juncture of the ceiling and northwest corner of the west extension.

7. The white solid-surface kitchen counter is scuffed and dirty. The base of the integral sink is crazed. The gap between the counter and backsplash is open and dirty.

8. The kitchen appliances are worn.

9. Generally, the exposed surfaces of the kitchen wall construction are scuffed and worn.

ROOM 107

1. The wood floor is abraded and scuffed; the finish is worn. The (east-west) floorboards appear to deflect near the center of their span. The floorboards at the south end of the room are loose.

2. The paint coatings on the wood trim are built-up, and the molding profiles are obscured.

3. There are horizontal and vertical cracks in the wood paneled reveal of the opening between

PROBLEMS OF REPAIR

the living room (103) and room 107.

4. There is horizontal cracking in splayed paneling of the west door reveal. Two lights in the transom above the west door are cracked. The dark brown, grained finish on the glazed doors is chipped, exposing earlier paint coatings. Unsuccessful attempts have been made to touch-up missing areas of finish; the coatings are uneven, and the touch-up repairs do not match the surrounding finish. The upper mitered joints of the door architrave have significant gaps.

5. The west architrave at the south door opening has been forced apart from the door frame by the screws of the door hinges. The wood surrounding the upper hinge mortise has splintered. The movement of the raised panels in the door has caused the dark brown, grained finish at the perimeter of the panel to crack, exposing lighter paint coatings.

6. The plaster ceiling at the north end of the space is cracked and blistered. Water damage has occurred; the paint is peeling, and the plaster is friable.

7. There are small areas of cracked and peeling paint on the east wall surface.

8. The painted finish at the juncture of the wall and baseboard cap molding on the west wall is cracked. The painted finish behind the southwest radiator is dirty.

9. The heating pipe penetrations at the ceiling and floor, in the southwest corner of the space, have rough openings. The pipe is not insulated.

ROOM 108

1. There is no apparent source for heating in this space beyond the excessive radiant heat levels from room B11 below.

2. The flooring is obscured by carpet.

3. The painted finish on the doors of the closet (108A) is chipped.

4. Shelving obscures the east wall to the north of the closet (108A); however, friable plaster is visible behind the shelves. This damage appears to be the result of a water infiltration associated with a failed downspout at the inside corner of the southwest addition and original pavilion (see B07 for additional information).

5. The paint coatings on the wood trim are built-up, obscuring the molding profiles.

6. There are north-south and east-west hairline cracks in the plaster ceiling.

7. A window air-conditioning unit is installed

in the southeast window opening, with flanking acrylic panels. The air-conditioning unit is visually obtrusive.

8. Shelving obscures the wall beneath the south windows.

9. The plaster fascia surrounding firebox closure has horizontal cracks immediately above the hearth.

10. There are minor hairline cracks in the wall plaster.

11. There is a small area of blistered and peeling paint at the juncture of the ceiling and chimney mass on the west wall.

ROOM 109 BATHROOM

1. The seams in the cork floor tile are raised.

2. There are hairline cracks in all of the painted plaster ceiling and wall surfaces.

3. The painted finishes on the wood trim, window, and door are built-up. There are uneven layers of paint, and the molding profiles are obscured.

4. The joint between the ceramic tile wall surround and the cast iron tub is open.

ROOM 201 STAIR HALL

1. The wood floor is abraded and scuffed; the finish is worn.

2. The braced wood grab bar at the east side of the stair landing is visually obtrusive; it was not designed as a contextual element.

3. The paint coatings on the wood trim are built-up; the molding profiles are obscured.

4. Surface-mounted telephone station wire has been stapled to the baseboard cap moldings and the door architraves.

5. Evidence of friable plaster has been masked by later paint coating(s) immediately beneath the entablature, at the intersection of the northeast curved wall surface and the east wall.

ROOM 202 HALL

1. The wood floor is abraded and scuffed.

2. The paint coatings on the wood trim are built-up; the molding profiles are obscured.

3. The baseboard cap molding is generally separated from the plaster wall surface.

4. Telephone station wire is stapled to the curved baseboard cap molding on the east wall.

5. The wall surfaces are scuffed; there are areas of cracked and peeling paint.

PAVILION IX

6. There is clear evidence of a roof leak at the west end of the ceiling. The paint on the ceiling and west wall (above the door architrave) is peeling, and the finished plaster surface is water stained. The paint on the wood entablature is cracked and peeling.

7. The plaster on the west wall has been built-up, nearly obscuring the reveal of the trim surrounding the door architrave.

ROOM 203 BEDROOM

1. The wood floor is abraded; the finish is worn.

2. Television coaxial cable is routed along the intersection of the baseboard and floor, from the east window to the southwest corner of the room.

3. The finish on the dark, grained doors to the south and west is chipped, exposing earlier finishes and the wood substrate. The doors bind on the plinth blocks beneath the door architraves.

4. The paint finishes on the wood trim are built-up; the molding profiles are obscured.

5. A horizontal crack extends the full width of the recessed wood panel beneath the north window. The finishes on the panel and window reveal are cracked along the joints of their construction. The heat from the adjacent radiator is contributing to this problem.

6. An air-conditioning unit has been mounted in the north window opening with flanking acrylic panels. The installation is visually obtrusive.

7. Two lights in the lower sash of the north window are cracked.

8. Two lights in each of the three sash of the east window are cracked. The painted finish along the interior south window stop is cracked along its juncture with the splayed window reveal. The painted finish along the bottom rails of the sash is cracked, crazed, dirty, and peeling.

9. There are cracks and peeling paint along the mitered construction of the entablature at the northeast corner of the room. There is water staining on the plaster beneath the entablature.

10. The mitered joints of the window architraves have separated. The east architrave of the north window has an 18" diagonal crack.

11. There are hairline cracks in the plaster wall surfaces.

12. The paint coatings on the fireplace surround and mantle are heavily built-up. The trim of the fireplace surround is abraded at the height of the baseboard.

ROOM 204 BEDROOM

1. The wood floor is abraded and scuffed.

2. Large single panes of glass have been adhered to the interior stops of the windows. The cavity between the window sash and the interior storm glazing is dirty; the paint on the sash is cracked and peeling.

3. A single light in the upper sash of the northwest window is cracked.

4. A small isolated area of the painted ceiling finish has popped off the plaster near the southeast corner of the room.

5. There is a vertical crack in the plaster wall surface beneath each of the window sills. The crack at the northwest window opening extends between the baseboard and window sill.

6. A diagonal hairline crack, extending upward from the top of the north architrave on the west door, has been covered with the latest application of paint.

7. Generally, the dark wood graining on the east face of the west door has been chipped, exposing earlier finishes. The west face of the door is painted white and has an excessive buildup of paint coatings that obscure the molding profiles.

ROOM 205 BEDROOM (ORIGINAL PARLOR)

1. The wood floor is abraded, and the finish is worn.

2. The paint finishes on the wood trim are built-up; the molding profiles are obscured.

3. The wood graining on the east door is chipped and cracked, exposing earlier finishes. The door binds on the plinth block beneath the north architrave. The south architrave and door jamb have been heavily abraded by the latch-bolt; the strike is broken.

4. There are hairline cracks and areas of peeling paint on the wall surfaces; and there are visible cracks between the wood trim and plaster walls.

5. There are cracks in the painted finish at the construction joints in the entablature, especially flanking the triglyphs, and at the inside mitered corners of the entablature.

6. There is water staining on the entablature moldings at the southwest corner of the room. Water infiltration at this corner of the room has caused the paint to peel from the plaster.

7. The inside corners of the frieze are dirty and

PROBLEMS OF REPAIR

indistinct where the applied figural composition pieces meet at a ninety degree angle. Paint buildup and the difficulty of cleaning have contributed to this problem.

8. A single light in the lower sash of the southwest window is cracked.

9. Large single panes of glass have been adhered/taped to the interior stops of the windows. The cavity between the window sash and the interior storm glazing is dirty and populated with dead insects.

10. The moldings beneath the recessed panels in the splayed window reveals are heavily abraded. This damage appears to have been caused by the previous installation of Venetian blinds.

11. Telephone station wire has been stapled to the baseboard and cap molding along the south and east walls.

12. The baseboard cap molding has separated from the wall surface along the east, south and west walls.

ROOM 206 VESTIBULE

1. The wood flooring is abraded and worn.

2. The paint coatings on the wood trim are built-up; the molding profiles are obscured. The painted finish at the exposed edges of the trim is chipped.

3. The dark brown painted finish on the west doors is cracked and chipped, exposing earlier layers of paint.

4. There are areas of painted plaster wall finishes that are cracked and delaminating. At the juncture of the ceiling and east wall the plaster is friable, and the painted finish is blistered and peeling. This damage is the result of a roof leak.

ROOM 207 CLOSET

1. The wood flooring is scuffed.

2. The east wall is obscured by casework.

3. The painted plaster finish on the west wall of the closet is scuffed, cracked and peeling.

4. The painted plaster finish on the ceiling is uneven, crazed and peeling. There are cracks in the plaster along the juncture of the ceiling and east wall, at the inside corner of the east and south walls, and at the inside corner of the east and north walls.

5. The west wall plaster above the closet alcove has a network of cracks.

6. The paint coatings on the wood trim are built-

up; the molding profiles are obscured.

7. The paint coatings on the south door are built-up; the molding profiles are obscured. There are areas of uneven paint on the north face of the door, where hooks have been removed. The dark graining on the south face of the door is chipped, exposing earlier finishes.

ROOM 208 BATHROOM

1. Vinyl floor tile obscures the wood flooring in the bathroom.

2. The painted finish on the wood trim is built-up; the molding profiles are obscured.

3. There are areas of uneven paint on the south door, where hooks have been removed; and there is adhesive residue where tape has been applied to the south face of the door.

4. The painted plaster finish on the east wall, behind the toilet tank, is cracked.

5. Uneven paint layering on the ceiling has been masked by the most recent coat of paint.

6. There is a small area of uneven paint and minor hairline plaster cracks on the south wall; these have been obscured by the most recent coat of paint.

7. There is a window air-conditioning unit installed in the window opening, flanked by acrylic panels. This is a visually obtrusive installation.

8. The sash at the west window are dirty.

ROOM 209 BATHROOM

1. The cork floor tile between the toilet and the tub is curling and separating along the seams.

2. The paint coatings on the wood trim are built-up; the molding profiles are obscured.

3. Hairline cracks and uneven layers of paint on the ceiling have been encapsulated beneath the most recent application of paint.

4. The door to the closet (210) is missing.

5. A single light in the upper window sash is cracked.

6. There is a window air-conditioning unit installed in the window opening, flanked by acrylic panels. This is a visually obtrusive installation.

ROOM 210 CLOSET

1. The walls surfaces are scuffed.

2. The paint coatings on the wood trim are built-up; the molding profiles are obscured.

PAVILION IX

3. There is uneven paint layering on the window architrave.

4. The upper window sash has lost its integrity; the bottom rail of the sash has dropped away from the stiles and muntins.

5. A single light in the lower window sash is cracked.

STUDENT ROOM NO. 53 (NORTH)

1. Much of the wood flooring is obscured by a rug and furniture.

2. The plaster ceiling is blistered, friable, cracked and uneven from many generations of roof leaks and patching.

3. The wall plaster is dirty, scarred, patched, and uneven. Much of the damage appears to be the result of hanging things on the walls. The damaged plaster on the west wall, between the window opening and ceiling appears to be the result of water infiltration.

4. The paint buildup on the window architrave and splayed reveals obscures the molding profiles. The painted finishes are dirty. A light in the lower sash is cracked. The window architrave has been scarred by generations of drapery hardware.

5. The hot and cold water faucets are dripping. The porcelain finish on the cast-iron sink is worn and rust-stained.

6. The plastered firebox surround is chipped and cracked. There are vertical cracks in the wood architrave that surrounds the fireplace.

7. Furniture obscures much of the wall surface.

STUDENT ROOM NO. 55 (SOUTH)

1. The wood flooring is abraded and has uneven layers of finish.

2. The painted finish on the plaster ceiling has uneven layers. Holes in the plaster have been poorly patched. Roof leaks have caused the paint to peel. A hairline plaster crack extends from the west side of the chimney mass to the north wall. Friable and uneven plaster at the southwest corner of the ceiling appears to be the result of a roof leak. An area of the plaster ceiling (approximately one foot in diameter) along the north wall, and near the northwest corner, is friable. This appears to be the result of a roof leak.

3. The walls are obscured by shelving, furniture, and built-in casework. The exposed wall plaster is scuffed, dirty and abraded. The plaster is irregular from generations of holes and patching.

4. The plaster above the baseboard, to the east of the chimney mass, is friable; and the painted finish is peeling.

5. The door and architrave are significantly abraded; the buildup of paint obscures the molding profiles. The raised panels in the door are cracked. The finishes at the juncture of the door architrave and plaster wall are cracked; there is an irregular buildup of paint and filler.

6. The plastered surround of the firebox is cracked and chipped.

7. The porcelain finish on the cast-iron sink is chipped and scratched. The exposed cast iron is rusted.

8. The paint buildup on the window architrave and sill obscures the molding profiles. The painted filler between the inner window stop and the splayed window reveal is cracked. The outer, aluminum-framed screen is deformed.

9. The plaster wall surface flanking the window opening is irregular; the paint is peeling in localized areas.

PAVILION IX

RECOMMENDATIONS

This historic structure report summarizes the findings of a comprehensive physical and archival investigation of Pavilion IX. Primary and secondary archival sources have been consulted with regard to original construction records, alterations, University development and maintenance, and the history of residency. A visual survey of existing building conditions has been completed and an assessment of problems has been prepared. Investigatory probes uncovered hidden conditions and helped to corroborate archival evidence. The collected information established a benchmark for current and future preservation efforts. The historic structure report should be used to ensure the integrity of the structure and of the remaining historic building fabric, while accommodating changes required for modern needs.

The building is the artifact. Efforts to restore and preserve it should be of a curatorial nature. The physical and archival information should be compared and contrasted to yield the most appropriate treatment. Attempts to recreate the intent of Thomas Jefferson without actual evidence will remain suspect. Decisions must be based on irrefutable evidence, not vague suggestions. It will be of more value to preserve the remaining physical evidence than to destroy it in the process of “restoring” the building.

As originally conceived, the pavilion was designed to house teaching and living space. While the building’s primary use has been transformed to a residential function, the use remains consistent with the original intent. While a building’s long term survival is dependent on its continued use, decisions made to accommodate current needs must be tempered by the knowledge that a building’s intrinsic value may be destroyed by the nature and extent of improvements.

The building should be entrusted to the care of architects and craftsmen trained in the conservation of historic building fabric. Accurate restoration work is not easy and often requires extraordinary dedication to excellence. Trained architects and craftsmen develop sensitivity to historic materials and the way they were used. Restoration specialists understand that inappropriate, expedient solutions often cause irreparable damage.

PAVILION IX

The renovation and installation of building systems often causes substantial damage to historic buildings. New electrical, plumbing, and mechanical systems often require large amounts of space and the destruction of original building fabric. Building systems can be camouflaged once they have been installed; however, it is the underlying damage inflicted by their installation that threatens the building's integrity. These systems should only be designed by engineers who specialize in the integration of building systems in historic structures, and the work should be coordinated with restoration architects to insure that the least intrusive methods of installation are pursued. Building systems must be skillfully designed to provide adequate levels of comfort while conforming to strict building conservation requirements.

Concern for preservation should be extended to all original building fabric and to the cumulative history of the structure. The windows, doors, hardware, flooring, plaster, and decorative finishes should be conserved and maintained. Where historic elements are missing they should be replaced with exact, dated replicas. Original material, including that which is considered seemingly insignificant, should never be replaced for cosmetic reasons, or for the convenience of construction. Period nails and screws are representative of early building technology and are as invaluable to Jefferson's buildings as are the architectural moldings.

While a historic structure report provides a concise summary of available information, new methods of investigation, new research, and additional evidence remain to be discovered. The historic structure report presents a process of collecting and organizing information. This should be an ongoing process, not a stagnant end product. Additional above-ground and subterranean archaeology should be undertaken. Significant evidence of the original roof and parapet remains to be uncovered. The extent of early gas, electric, and water utility systems remains to be revealed. Cultural and societal aspects of nineteenth century life remain to be examined, and future changes remain to be recorded. The historic structure report should continue to be the repository of history and change.

Specific recommendations for physical improvements and continued investigations follow below.

RECOMMENDATIONS

EXTERIOR

ROOF

1. Remove the sheet metal and slate roofing at the perimeter of the hipped roof to expose the remaining evidence of the early tin plate roofing and wood parapet. Restore the tinplate roofing, and if sufficient evidence remains, re-establish the roof parapet.
2. Replace the rusting sheet metal roofing on the rear porch and addition. The flat-lock seam metal roofing should employ smaller pans of historically accurate dimensions; this will insure the proper alignment of the metal seams.
3. Replace the remaining terne-plated steel flashings at chimneys and roofs with more durable sheet metal that is compatible with recently installed terne-coated stainless steel flashing. The excessive use of sealant should be avoided; there should be a greater reliance on traditional building technology and a judicious use of modern building technology.
4. Reconfigure the flashing and curb details of the colonnade railings at the student room roofs so that storm water is effectively drained away from the building, not into the building construction.
5. The resilient walking service laid over the sheet metal roofing of the colonnade should be removed. This material retains moisture, and it obscures the condition of the underlying roofing.
6. Examine the remaining physical evidence of the interconnecting colonnade roof stair. If sufficient evidence remains, re-establish the stair.

MASONRY

1. Chemically clean the brick masonry, removing dirt, biological growth, and paint.
2. Repoint the masonry with lime-rich mortar matching the color, profile, and composition of the early mortars.
3. Preserve and restore the penciled mortar joints and stained brickwork on the east elevation of Pavilion IX and the student rooms.
4. Restore the brick masonry construction in the areaways to the north of the building.
5. Replace broken and spalled brick, and reconstruct areas of brick masonry where previous reconstruction efforts have failed and where previous repairs do not match the color, size, and quality of the early brick construction.
6. Remove surface-mounted electrical conduit, coaxial television cable and telephone wiring from exterior wall surfaces.

PAVILION IX

7. Remove the built-up parging from the columns supporting the colonnade. Restore the parging with distinct, accurate profiles.
8. Clean and inspect the chimney flues at Pavilion IX and at the flanking student rooms.
9. Reset the stone steps of the colonnade to the north of Pavilion IX.

WOODWORK

1. Chemically strip built-up paint coatings on the exterior woodwork. Apply prime and finish coats of paint, matching the appearance of the original paint as determined through paint analysis.
2. The colonnade railing construction should be repaired where construction joints are open to the weather. Flashing should be introduced where none exists and where a weather-tight seal is completely dependent on the integrity of sealant. Warped and rotted woodwork should be replaced. Flat wood curbing should be reworked to shed water.

WINDOWS AND DOORS

1. Restore the windows. Chemically strip the paint and remove the glazing putty. Replace cracked and broken glass and install new glazing putty. Replace rotted wood, using traditional Dutchman repairs to the greatest extent possible. Prime and paint the sash and trim. Service the windows, re-hanging the sash to ensure proper operation and to reduce excessive air infiltration. Install custom fabricated interior storm windows. Retain early moldings and stops to the greatest extent possible.
2. Remove the window air-conditioning units.
3. Re-hang and restore the window shutters. Reconstruct missing shutters.
4. Replace the protective screens at the basement window openings on the east elevation. Replace the screens in the stair risers at the east entry. Explore the use of new unobtrusive contextual designs for these elements.

STORM WATER DRAINAGE

1. Replace rusting steel downspouts.
2. Ensure that the underground storm water drainage system is functioning properly. Determine the cause of the prolonged damp and wet conditions in the areaways to the north of the building.
3. Replace the leaking downspouts that are routed beneath the student rooms.

RECOMMENDATIONS

4. Examine ways to improve storm water drainage so that water is effectively carried away from the base of the building.

INTERIOR

Generally, the interior spaces of the original circa 1822 structure should be preserved in their historic forms and restored where necessary. The circa 1831 modifications to the west wall of Living Room (103) should be retained. Original paint colors and interior finishes should be replicated as determined through paint analysis.

Pavilion IX should continue to be used as a residence, and the spaces within the original building should continue to be used much as they have been, with the more formal spaces on the first floor, family bedrooms and sitting rooms on the second floor, and informal office, living, and storage spaces in the basement.

The bathrooms and kitchen should remain in the rear additions, so that invasive construction required for plumbing and ventilation is restricted to less historically sensitive areas of the building.

WINDOWS AND DOORS

1. Service and replace loose and missing hardware. Retain the early hardware, including cut nails and hand-cut screws.
2. Re-establish the original double-hung sash configuration in the north and east window openings of Rooms (B06) and (B07), respectively. Preserve and restore the original sash components remaining in the window openings of Room (B06).
3. Install structural wood lintels above the east window openings in Stair Hall (B01) and Room (B05).
4. Using materials stored in the attic, re-establish the original window opening in the west wall of the dining room. Reconstruct the missing sash, using mirrored glass.
5. Restore missing doors and re-establish the original door swings.
6. Restore the proper operation of doors so that they do not bind on the floor or door frame. Repair all period door hardware and replace modern hardware with appropriate reproductions.

FINISHES

1. Renovate the kitchen, replacing the casework and appliances.

PAVILION IX

2. Renovate the bathrooms and laundry, re-designing the casework so that it better accommodates the historic context and the historic building fabric. Consider the removal of the basement bathroom and elimination of the raised platform required for gravity drainage of the toilet and tub.
3. Replace deteriorated and moisture-damaged plaster.
4. Rake out plaster cracks and repair plaster.
5. Repair the pine flooring, avoiding wholesale replacement.
6. Restore the original stairway in the southeast corner of the building, properly repairing the mitered joints of the handrail. Reinforce the stair and rail at the basement landing so that visible means of shoring are not required. Structurally reinforce the lintel above the basement window opening to support the weight of the stair and first floor landing. Restore the structural integrity of the floor framing and subsided floorboards at the first floor landing.
7. Install brick flooring to match original flooring in the basement.
8. Restore the integrity of the floor framing and floorboards in Room (107).
9. Preserve the existing original attic access hatch. Refrain from modifying early construction to accommodate modern mechanical equipment.
10. Preserve the original ceiling materials at the second floor level, especially those in the hall and stair hall where original plaster and lath remains.
11. Selectively strip interior woodwork of excessive paint build-up, using chemical and mechanical means that will restore molding profiles while preserving evidence of early finishes.

BUILDING SYSTEMS

1. Provide a new mechanical system with provisions for heating and cooling.
2. Avoid placement of mechanical equipment in the attic of the original building. Mechanical equipment can be a potential fire ignition source and a cause of plumbing leaks. Limited attic access makes equipment maintenance difficult. To the greatest extent possible, mechanical systems should be installed in accessible locations and kept out of historically sensitive spaces.
3. Relocate the piping associated with the central grounds heating system, removing all heat distribution piping from the building that does not specifically serve the heating needs of Pavilion IX.

RECOMMENDATIONS

4. To the greatest extent possible, remove the central grounds heat distribution piping from the crawlspaces beneath the student rooms. These spaces are cramped, and there is insufficient space for adequate maintenance.
5. Replace electrical service panels, wiring, and devices throughout the building, complying with the current version of the National Electrical Code. Remove surface-mounted electrical conduit. Take precautions to preserve historic building fabric, including evidence of the early knob-and-tube wiring.
6. Preserve the remaining evidence of piping and fittings for gas illumination, much of which remains in the attic.
7. Replace the domestic plumbing system and fixtures throughout the building. Take precautions to preserve the historic building fabric.
8. Install a fire detection system throughout the building that communicates with a central reporting facility.
9. Investigate the installation of a limited fire suppression system with sprinklers in the attic and mechanical spaces. Every effort should be made to avoid damaging the original first and second floor spaces with the installation of a new fire suppression system.

ILLUSTRATION ACKNOWLEDGEMENTS

Avery Architectural and Fine Arts Library, p. 45

A Calendar of the Jefferson Papers of the University of Virginia (Jefferson Papers),
Special Collections, University of Virginia Library, pp. 14, 27

Facilities Planning and Construction Department Resource Center Library, 071615,
p. 40; 099036, p. 44; p. 48

Library of Congress, pp. 47, 50

The Library of Virginia, p. 29

Tracy W. McGregor Library of American History, Special Collections Department,
University of Virginia Library, Broadside 1856.B64, p. 68

Special Collections Department, University of Virginia Library, MSS 2332, p. 30; p. 76

Visual History Collection, Special Collections Department, University of Virginia
Library, prints 00002, p. 10; prints 00001, p. 32; prints 00012, p. 36; prints 00018,
RG-30/1/8.801 & Betts #46, p. 37; RG-30/1/10.011, pp. 46 , 52

All other drawings and photographs by John G. Waite Associates, Architects PLLC

